

# The Gazette of Pakistan

PUBLISHED BY AUTHORITY

No. 7]

KARACHI, WEDNESDAY, FEBRUARY 17, 2021

## C O N T E N T S

	PAGES		PAGES
<b>PART I—</b> Notifications regarding appointments, promotions, etc., issued by Ministries/ Divisions of the Government of Pakistan, Department of the Auditor-General of Pakistan and the Supreme Court of Pakistan other than the Ministry of Defence and Ministry of Defence Production .....	161—189	<b>PART IV—</b> Notifications issued by the minor administrations and miscellaneous notification not included in any other part .....	-Nil-
<b>PART II—</b> Notifications issued by the Ministry of Defence and Ministry of Defence Production	45—49	<b>PART V—</b> Notifications etc., issued by The Patent Office.	41—52
<b>PART III—</b> Notifications issued by the High Courts, the Federal Public Service Commission and by the Attached and Subordinate Offices of the Government of Pakistan .....	97—110	<b>PART VI—</b> Advertisements and Notices issued by Corporate Bodies and Private Individuals on payment .....	-Nil-
		<b>SUPPLEMENT NO.</b>	
		Weekly, notification of cases and deaths from quarantinable diseases .....	

## PART I

### Notifications regarding appointments, promotions, etc. issued by Ministries/Divisions of the Government of Pakistan, Department of the Auditor-General of Pakistan and the Supreme Court of Pakistan other than the Ministry of Defence and Ministry of Defence Production

PRIME MINISTER'S OFFICE (PUBLIC)

Islamabad, the 3rd February, 2021

**No. F.6(26)/2008-Admn.**—On attaining the age of superannuation Syed Qamar Ali, Assistant Private Secretary (BS-16) of Prime Minister's Office (Public), shall stand retired from Government Service on 15th May, 2021.

HAIDER MUNAWAR CHEEMA,  
Section Officer (Admn.).

[BOARD OF INVESTMENT]

Islamabad, the 1st February, 2021

**No. 3(217)-HR/2021.**—In pursuance of Establishment Division's Notification No.1/18/2021-E-4, dated 27th

January, 2021 Mrs. Suriya Jamal, a BS-20 officer of Information Group has assumed the charge of the post of Director General (BS-20), Board of Investment, Islamabad on 27th January, 2021.

Islamabad, the 3rd February, 2021

**No. 4(4)-Admn/2005.**—Mr. Allah Wasayo Bhutto, Assistant Private Secretary, Board of Investment, Islamabad is hereby granted twelve (12) days leave on full pay (LFP) from 8th February, 2021 to 19th February, 2021 with permission to leave the station.

On the expiry of above leave, he is likely to resume his duty on the same post and station.

ABDUL SATTAR,  
Deputy Director (HR).

## NATIONAL ACCOUNTABILITY BUREAU

Islamabad, the 4th January, 2021

**No. 3(1702)/L/2016/PM-V.**—The Competent Authority has been pleased to grant 90 days maternity leave (LFP) in respect of Ms. Sana Khalil, Deputy Director (BPS-18), National Accountability Bureau (Lahore), with effect from 22nd December, 2020 to 21st March, 2021.

On the expiry of leave, the lady officer shall resume her duties of the same post and station.

MUHAMMAD ZEESHAN HAIDER,  
Deputy Director (PM-V).

\_\_\_\_\_

Islamabad, the 6th January, 2021

**No. 3(601)/P/2007/PM-III.**—DG (HRM) has been pleased to approve 12 days medical leave with full pay in respect of Mr. Zaheer Ahmad, Deputy Director (BPS-18), NAB (HQ), Islamabad with effect from 18th January, 2021 to 29th January, 2021.

On expiry of leave, the officer shall resume his duties at the same post.

MUHAMMAD SHOAIB,  
Deputy Director (PM-I).  
(HRM Division).

\_\_\_\_\_

Islamabad, the 7th January, 2021

**No. 1(765)/Admn/2018/189.**—Director General NAB(R) / Islamabad has been pleased to grant 3 days *ex-post facto* leave on full pay (LFP) with effect from 4th November, 2020 to 6th November, 2020 in respect of Mr. Zia Ullah Khan, Additional Director (BPS-19), NAB Rawalpindi / Islamabad.

On the expiry of leave, the officer has resumed his duties of the same post at the same station.

ERIC PAUL,  
Deputy Director (Admn.).

\_\_\_\_\_

Islamabad, the 8th January, 2021

**No. 3(1703)/L/2016/PM-V.**—After providing full opportunity of hearing *i.e.* show cause notice & personal hearing and consequent upon proven charges of "Misconduct" & "Inefficiency" on account of callous and careless attitude towards official working, the Authorized Officer

has imposed following minor penalty in terms of section 11.03(1)(a)(ii) of NAB Employee's Terms & Conditions of Service (TCS) 2002 upon Mr. Zohair Hassan, Assistant Director (BPS-17) NAB (KP) Peshawar:-

*"Withholding of promotion for a period of two (2) years from the date he becomes eligible for promotion".*

2. The officer can submit his appeal within 30 days as per Chapter 13 of NAB Employee's TCS 2002.

LUBNA BASHIR,  
Assistant Director (PM-II).

\_\_\_\_\_

Islamabad, the 8th January, 2021

**No. 3(1366)/S/2013-PM-III.**—The Authorized Officer *i.e.* DG(HRM) in exercise of powers conferred under Section 11.01 of NAB Employees, TCS-2002 has imposed a minor penalty of "withholding of promotion for a period of two (2) years from the date he becomes eligible for promotion" upon Mr. Jahangir Jawed Memon, Assistant Director (BPS-17) NAB (Karachi), under clause 11.03 (1)(a)(ii) of NAB's TCS-2002 on having been found guilty of the charge of "misconduct".

The opportunity of appeal is valid within 30 days of issuance of this Order.

**No. 3(1366)/S/2013/PM-III.**—The Competent Authority has been pleased to approve posting / transfer of Mr. Jahangir Jawed Memon, Assistant Director (BPS-17) from NAB (Karachi) to NAB (Multan) with immediate effect and until further orders.

The officer is allowed joining time & TA / DA as per rules.

HAMZA NIHAL TARIQ,  
Assistant Director (PM-III).

\_\_\_\_\_

Islamabad, the 1st January, 2021

**No. 1(711)/Admn/2016/136.**—Director General NAB (R) / Islamabad has been pleased to grant 12 days leave on full pay (LFP) with effect from 4th January, 2021 to 15th January, 2021 in respect of Mr. Muhammad Kamran, Deputy Director (BPS-18), NAB Rawalpindi / Islamabad.

On the expiry of leave, the officer will resume his duties of the same post at the same station.

MUHAMMAD QASIM,  
Assistant Director (Admn.).

## CABINET SECRETARIAT

Islamabad, the 4th January, 2021

(Cabinet Division)

Islamabad, the 29th December, 2020

**No. 1/75/Coord/2020-RA-IV.**—The Competent Authority has been pleased to appoint the following as Members, Board of Governors of the Special Technology Zones Authority, under section 6(d) of the Special Technology Zones Authority Ordinance, 2020:-

- |     |   |                             |
|-----|---|-----------------------------|
| 1.  | Dr. Abdul Hafeez Shaikh, Federal Minister for Finance & Revenue   | <i>Ex-Officio</i><br>Member |
| 2.  | Mr. Hammad Azhar, Federal Minister for Industries and Production.   | -do-                        |
| 3.  | Syed Amin ul Haque, Federal Minister for IT & Telecom.  | -do-                        |
| 4.  | Ms. Sania Nishter, Sepcial Assistant to the Prime Minister on Poverty Alleviation and Social Safety Nets. | -do-                        |
| 5.  | Ms. Maheen Rahman   | Independent<br>Member       |
| 6.  | Dr. Shafiq Qadri  | -do-                        |
| 7.  | Mr. Noor Rahman Abid  | -do-                        |
| 8.  | Dr. Nazar Zaidi   | -do-                        |
| 9.  | Mr. Sikandar Mustafa Khan   | -do-                        |
| 10. | Mr. Ashar Nazim   | -do-                        |

Islamabad, the 31st December, 2020

**No. 1/75/Coord/2020-RA-IV.**—The Prime Minister has been pleased to constitute the following Selection Board for Selection of the post of Chairperson, Special Technology Zones Authority (STZA):-

- |    |   |                       |
|----|---|-----------------------|
| 1. | Federal Minister for Industires & Production    | Chairman/<br>Member   |
| 2. | Secretary, Cabinet Division                     | Member                |
| 3. | Additional Secretary-II, Establishment Division | Mmeber                |
| 4. | Additional Secretary, Cabinet Division          | Member /<br>Secretary |

NAZIR AHMED,  
Deputy Secretary (RA).

**No. PF 271/2007 Admn (NDC).**—With the approval of Cabinet Secretary, Rana Saleem Iqbal, Deputy Director (NDW), (BS-18) is assigned to hold current charge of the post of Director (NDW) (BS-19), Cabinet Division with effect from 1st January, 2021, in addition to his own duties, for a period of three (3) months or till the posting of an officer on regular basis, whichever is earlier.

**No. 1/3/2019-Admn-II.**—In pursuance of Establishment Division's O.M. No.32/2/2019-SP dated 15th December, 2020, Mr. Asif Mehmood, Admn Officer (BS-17, declared surplus from Technical Panel on Teachers Education (Defunct TPTE), defunct Capital Administration and Development Division (CA&DD) now under Cabinet Division working against supernumerary post and placed at the disposal of Cabinet Division till adjustment, has been absorbed on permanent basis as Statistical Officer (BS-17), in Pakistan Bureau of Statistic, under the administrative control Ministry of Planning Development and Special initiatives. Accordingly, the officer is hereby relieved to join his new assignment with effect from 4th January, 2021.

Islamabad, the 8th January, 2021

**No. PF(1052)-Admn-II.**—In pursuance of General Headquarters, Military Secretary Branch's Rawalpindi postings Order No.0354/25205/MS-4A/211 dated 18th December, 2020, PA-25205-Brig. Sajjad Salim, SI(M), afwe, psc, ptsc, te has relinquished the charge of the post of Secretary (NTISB), (BS-20), NTISB Wing, Cabinet Division with effect from 30th December, 2020.

**No. PF(1170)-Admn-II.**—In pursuance of General Headquarters, Military Secretary Branch Rawalpindi Letter No.0354/32774/MS-4A/207 dated 9th December, 2020, and Movement Order No.0119/32774/Admn Comd. (a) dated 31st December, 2020, PA-32774 Brig. Muhammad Mansoor Sahgal Psc, te, has assumed the charge of the post of Secretary (NTISB), (BS-20), National Telecom & Information Security Board Wing, Cabinet Division with effect from 31st December, 2020 on secondment basis, on standard terms and conditions as contained in JSI 4/85.

**No. PF.(876)-Admn-II.**—With the approval of Competent Authority *i.e.* Additional Secretary-III, Sheikh Muhammad Abdul Rafe, Section Officer (Security), is assigned to hold additional charge of the post of Section Officer (Sq. n.), Cabinet Division with immediate effect, in addition to his own duties for a period of three (3) months or till posting of a regular officer, whichever is earlier.

This Division's Notification No.F.1-6/2016 Admn-II dated 1st January, 2021 regarding grant of Additional charge assigned to Mr. Mumtaz Ahmed, Section Officer (Hiring) for the post of SO (Sq.) is hereby withdrawn / cancelled.

Islamabad, the 11th January, 2021

**No. PF(899) Admn-II.**—With the approval of Cabinet Secretary, Mr. Qasim Rashid, Director (Prog.) is assigned to hold additional charge of the post of Deputy Secretary (Dev-II) / DDO / Signatory for the SAP Program), Development Wing, Cabinet Division with immediate effect, in addition to his own duties for a period of three (3) months or till posting of a regular officer, whichever is earlier.

Islamabad, the 12th January, 2021

**No. PF(1016)-Admn-II.**—With the approval of Cabinet Secretary, Miss Madiha Sadaf, Microfilming Officer (BS-17) is assigned to hold additional charge of the post of Section Officer (Record.), Cabinet Division with immediate effect, in addition to her own duties for a period of three (3) months or till posting of a regular officer whichever is earlier.

**No. PF(1035)-Admn-II.**—With the approval of Competent Authority *i.e.* Additional Secretary-III, Mr. Jamil Ahmed, Superintendent (BS-17), Cabinet Division, is assigned to hold current charge of the post of Section Officer (Cabinet), with effect from 14th December, 2020 for a period of three (3) months or till posting of a regular officer whichever is earlier.

**No. PF(1035)-Admn-II.**—With the approval of competent authority *i.e.* Additional Secretary-III, Mr. Muhammad Athar ud Din, Superintendent (BS-16), Cabinet Division, is assigned to hold current charge of the post of Section Officer (Pension Cell), with effect from 15th January, 2021 for a period of three (3) months or till posting of a regular officer whichever is earlier.

**No. PF(1035)-Admn-II.**—With the approval of competent authority *i.e.* Additional Secretary-III, Mr. Safdar Ali Shah, Assistant Marketing Officer (BS-16), Cabinet

Division, is assigned to hold current charge of the post of Section Officer (Lit-I), with effect from 18th December, 2020 for a period of three (3) months or till posting of a regular officer whichever is earlier.

Islamabad, the 13th January, 2021

**No. F.1-1/2016-Admn-II.**—With the approval of Additional Secretary-III, Mr. Amin ul Haq, Assistant Private Secretary (BS-16), Cabinet Division, is assigned to hold current charge of the post of Private Secretary (BS-17), with effect from 8th January, 2021, in addition to his own duties, for a period of three (3) months or till posting of a regular Private Secretary, whichever is earlier.

**No. F.1-1/2016-Admn-II.**—With the approval of Additional Secretary-III, Syed Ather Hussain, Assistant Private Secretary (BS-16), Cabinet Division, is assigned to hold current charge of the post of Private Secretary (BS-17), with effect from 4th January, 2021, for a period of three (3) months or till posting of a regular Private Secretary, whichever is earlier.

Islamabad, the 14th January, 2021

**No. PF(1133)-Admn-II.**—With the approval of Cabinet Secretary, Mr. Ghulam Mujtaba Joyo, Joint Secretary (Org) (BS-20), is assigned to hold additional charge of the post of Joint Secretary (Cabinet), with effect from 19th January, 2021, in addition to his own duties during the leave period of the officer.

**No. PF. (1133)-Admn-II.**—With the approval of Cabinet Secretary, Mr. Taimur Tajammal, Joint Secretary (Cabinet) (BS-20), has been granted 39 days leave *ex-Pakistan* on full pay from 19th January to 26th February, 2021 with permission to leave the Country on 19th January, 2021, under the Revised Leave Rules, 1980 subject to title. On expiry of leave *ex-Pakistan*, he will resume his duty on the same post and station.

Cabinet Division has "No objection" on proceeding abroad of the officer.

SARDAR MEHMOOD,  
Section Officer (Admn-II).

(Aviation Division)

Islamabad, the 3rd November, 2020

**No. 4-45/2006-ASF.**—Consequent upon the recommendations of Departmental Promotion Committee (DPC) made in its meeting held on 23rd October, 2020 following 21 Assistant Directors (BS-17) of Airports Security Force shall stand promoted to the post of Deputy Director (BS-18) with effect from as per remarks mentioned against each:-

S.No.	F/No.	Name	Remarks
1.	SF-825	Mr. Zaheer Ahmad	Promoted to the post of Deputy Director (BS-18) w.e.f. 23rd October, 2020.
2.	SF-883	Mr. Ghulam Shabbir	-do-
3.	SF-918	Syed Athar Hussain Zaidi	-do-
4.	SF-919	Mr. Najmul Bari	-do-
5.	SF-925	Syed Hadi Shah	-do-
6.	SF-931	Mr. Atiq-ur-Rehman	-do-
7.	SF-932	Syed Zill-e-Hussain	-do-
8.	SF-933	Mr. Aurangzeb	-do-
9.	SF-934	Ms. Yasmeen Mughal (F)	-do-
10.	SF-936	Mr. Khalid Hussain	-do-
11.	SF-937	Mr. Masood Ahmed	-do-
12.	SF-938	Mr. Mishal Din	-do-
13.	SF-940	Ms. Firdous Soomro (F)	Shall stand promoted to the post of Deputy Director (BS-18) subject to availability of vacancy.
14.	SF-941	Mr. Jahangir Ahmed	-do-
15.	SF-944	Mr. Muhammad Kashif	-do-
16.	SF-946	Mr. Ghulam Mustafa	-do-
17.	SF-947	Mr. Ibrar Khan	-do-
18.	SF-949	Mr. Tanveer Ahmed	-do-
19.	SF-951	Mr. Arbab Khanan Khan	-do-
20.	SF-952	Mr. Muhammad Mohsin Virk	-do-
21.	SF-953	Mr. Muhammad Israr	-do-

**No. 4-45/2006/-ASF.**—Consequent upon the recommendations of Departmental Promotion Committee (DPC) made in its meeting held on 23rd October, 2020 following 33 Inspectors (BS-16) of Airports Security Force shall stand promoted to the post of Assistant Director (BS-17) with effect from as per remarks mentioned against each:-

S.No.	F/No.	Name	Remarks
1.	US-2766	Mr. Amanat Masih	Promoted to the post of Assistant Director (BS-17) w.e.f. 23rd October, 2020.
2.	US-5662	Mr. Muhammad Ayaz	-do-
3.	US-5663	Mr. Yasir Arfat Bajwa	-do-
4.	US-5664	Mr. Muhammad Ramzan	-do-
5.	US-5665	Mr. Shabbir Ahmad	-do-
6.	US-3543	Mr. Sultan Qamar	-do-
7.	US-5666	Mr. Jan Muhammad	-do-
8.	US-4192	Mr. Azeem Masih	-do-
9.	US-3896	Mr. Muhammad Ali Ghouri	-do-
10.	US-2839	Mr. Rifaqat Ali Sajid	-do-
11.	US-3017	Mr. Ali Gohar Khan	-do-
12.	US-3158	Mr. Akhtar Hussain	-do-
13.	US-3146	Mr. Javed Iqbal	-do-
14.	US-3073	Mr. Muhammad Naseem	-do-
15.	US-3188	Mr. Muhammad Habib Khan	-do-
16.	US-3094	Mr. Muhammad Arif	-do-
17.	US-3140	Mr. Tariq Javed	-do-
18.	US-3114	Mr. Tariq Hussain	-do-
19.	US-2751	Syed Ahmed Abbas	Shall stand promoted to the post of Assistant Director (BS-17) subject to availability of vacancy.

S.No.	F/No.	Name	Remarks
20.	US- 3190	Mr. Niaz Akbar	Shall stand promoted to the post of Assistant Director (BS-17) subject to availability of vacancy.
21.	US-3183	Mr. Muhammad Parvez	-do-
22.	US-3126	Mr. Asif Jamal	-do-
23.	US-3127	Mr. Javed Muhammad	-do-
24.	US-3163	Mr. Muhammad Rafique	-do-
25.	US-3185	Mr. Javed Bhatti	-do-
26.	US-3124	Mr. Babar Hussain	-do-
27.	US-3134	Mr. Mehboob Ahmed	-do-
28.	US-3186	Mr. Raziq Mehmood	-do-
29.	US-3157	Mr. Tariq Mehmood	-do-
30.	US-3143	Mr. Ali Hassan	-do-
31.	US-3123	Mr. Muhammad Ibrahim	-do-
32.	US-3162	Mr. Atta Ullah	-do-
33.	US-3139	Mr. Mansoor Ahmad	-do-

**No. 4-45/2006-ASF.**—Consequent upon the recommendations of Departmental Promotion Committee (DPC) made in its meeting held on 23rd October, 2020, Mr. Aslam Pervaiz, Superintendent (BS-17) of Airports Security Force has been promoted to the post of Administrative Officer (BS-17) with effect from 23rd October, 2020.

**No. 4-45/2006-ASF.**—Consequent upon the recommendations of Departmental Promotion Committee (DPC) made in its meeting held on 23rd October, 2020, following 2 Superintendent (BS-16) of Airports Security Force are granted higher time scale in BPS-17 for the post of Superintendent from the date of completion of three years service in BPS-16:-

S. No.	Name
1.	Mr. Shamim Akhtar
2.	Mr. Raees Ahmed

ABDUL RAZZAQ BHATTI,  
Deputy Secretary (DMA).

(Establishment Division)

Islamabad, the 10th November, 2020

**No. 1/63/2009-E-6.**—The Federal Government has been pleased to approve the extension in additional charge of the post of Executive Director, Frequency Allocation Board (FAB) to Brigadier Musharaf Khan, Director General, National Frequency Management and Monitoring System (NFMMS), FAB under Cabinet Division for a further period of two (2) months with effect from 21st October, 2020 to 20th December, 2020 or till the appointment of regular ED, FAB, which is to be completed at the earlier under the rules/policy.

**No. F.12(10)/2009-E-3 (Police).**—Syed Muhammad Bilal, a BS-18 officer of Police Service of Pakistan, presently serving in Federal Investigation Agency (FIA), under Interior Division, is transferred and his services are placed at the disposal of Government of the Punjab, with immediate effect and until further orders.

Islamabad, the 11th November, 2020

**No. PF (864)/E-5(PAS).**—Capt. (Retd.) Noor-ul-Amin Mengal, a BS-20 officer of Pakistan Administrative Service, presently posted under Government of Balochistan, is transferred and his services are placed at the disposal of Government of the Punjab, with immediate effect and until further orders.

**No. 1/79/2005-E-4.**—Mr. Bilal Majeed, a BS-20 officer of Pakistan Audit and Accounts Service, presently at the disposal of Benazir Income Support Programme, is repatriated to his parent department *i.e.* Auditor General of Pakistan, with immediate effect.

**No. PF (1318)/E-5(PAS).**—Ms. Asma Sanaullah, a BS-18 officer of Pakistan Administrative Service, presently posted as Section Officer, Establishment Division, is transferred and her services are placed at the disposal of Interior Division, for further posting in Islamabad Capital Territory, Islamabad, against a BS-18 position, with immediate effect and until further orders.

**No. F.40/561/2013-E-I.**—The additional charge of the post of Secretary, Law and Justice Division, assigned to Raja Naeem Akbar, Senior Consultant (MP-I), Law and Justice Division, is further extended with effect from 8th November, 2020, for a period of three (3) months or till posting of a regular incumbent, whichever is earlier.

**No. PF (1096)/E-5(PAS).**—Khawaja Muhammad Sikandar Zishan, a BS-18 officer of Pakistan Administrative Service, presently posted under Government of Balochistan, is transferred and his services are placed at the disposal of Government of the Punjab, with immediate effect and until further orders.

**No. 1/84/2019-E-4.**—Mr. Farrukh Hussain Awan, Deputy Assistant Director, NADRA presently posted in Anti-Narcotics Force, Rawalpindi is repatriated to his parent department *i.e.* NADRA, with immediate effect.

Islamabad, the 12th November, 2020

**No.4/14/2019-E-4.**—With the approval of the Federal Government, PA-29582 Brigadier Rizwan Ahmed, Air Defence, is appointed as Deputy Director General (BS-20), Airports Security Force (ASF) as relief of PA-28198 Brigadier Muhammad Zubair, infantry on standard terms and conditions of secondment as contained in JSI 4/85, with immediate effect and until further orders.

**No. 4/14/2019-E-4.**—With the approval of the Federal Government, PA-30524 Brigadier Muhammad Shoaib Mughal, Artillery, is appointed as Director (BS-20) Airports Security Force (South), Karachi as relief of PA-29582 Brigadier Rizwan Ahmed, Air Defence on standard terms and conditions of secondment as contained in JSI 4/85, with immediate effect and until further orders.

**No. 4/14/2019-E-4.**—With the approval of the Federal Government, PA-30993 Brigadier Furqan Moazzam, Infantry, is appointed as Director (BS-20) Airports Security Force (North), Islamabad as relief of PA-28338 Brigadier Irfan Zafar, Infantry on standard terms and conditions of secondment as contained in JSI 4/85, with immediate effect and until further orders.

Islamabad, the 13th November, 2020

**No. F.12(10)/2009-E-3 (Police).**—Syed Muhammad Bilal, a BS-18 officer of Police Service of Pakistan, presently serving in Federal Investigation Agency (FIA), under Interior Division, is transferred and his services are placed at the disposal of Islamabad Capital Territory (ICT) Police, under Interior Division, with immediate effect and until further orders.

This Division's notification of even number dated 10th November, 2020 whereby he was transferred from Federal Investigation Agency (FIA), under Interior Division and his services were placed at the disposal of Government of the Punjab is cancelled *ab-initio*.

MARIAM KAYANI,  
Deputy Secretary.

Islamabad, the 10th November, 2020

**No. PF.922/2009-E-VII.**—This Division's notification of even number dated 2nd November, 2020 in respect of transfer / posting of Ms. Affaf Faiz Rasool Malik (OMG/BS-18), OSD, Establishment Division is cancelled / withdrawn *ab-initio*.



Islamabad, the 12th November, 2020

**No. PF.1064/2011-E-VII.**—Mr. Muhammad Mudasser Ahmed (OMG/BS-18), Section Officer, Economic Affairs Division is transferred and his services are placed at the disposal of National Vocational and Technical Training Commission (NAVTTTC), on deputation basis for a period of three years, on standard terms and conditions, with immediate effect and until further orders.

**No. PF.1097/2011-E-VII.**—Ms. Ambreen Zaidi, (OMG/BS-18), OSD, Establishment Division, is transferred and posted as Section Officer, Economic Affairs Division with effect from 24th November, 2020, as a replacement of Mr. Muhammad Mudasser Ahmed (OMG/BS-18).

**No. PF. 1103/2011-E-VII.**—Ms. Sara Jawad (OMG/BS-18), awaiting posting in Establishment Division is transferred and posted as Officer on Special Duty (OSD) in Establishment Division and granted 90 days leave on full pay (LFP) with effect from 16th October, 2020, subject to title.

This Division's Notification No.1090/2011-E-VII, dated 16th October, 2020 is hereby withdrawn *ab-initio*.

**No. PF.1079/2011-E-VII.**—The following transfers / postings are made as mentioned against each of the OMG officer with immediate effect and until further orders:-

S. No.	Name of the Officers	From	To
1.	Mr. Shahid Iqbal (OMG/BS-18)	Section Officer, Narcotics Control Division	Section Officer, Interior Division.
2.	Mr. Muhammad Zia-ul-Haq (OMG/BS-18)	Section Officer, Interior Division	Section Officer, Narcotics Control Division

SHAMS-UD-DIN,  
Section Officer.

Islamabad, the 12th November, 2020

**No. F.39/1037/2015-E-I.**—The un-availed portion of leave on full pay (LFP), granted to Ms. Humaira Zia Mufti, a BS-20 officer of Secretariat Group, presently posted as Officer of Special Duty (OSD), Establishment Division, Islamabad, *vide* this Division's notification of even number dated 2nd October, 2020 is hereby cancelled with immediate effect.

The officer is transferred and her services are placed at the disposal of National School of Public Policy (NSPP) Lahore, on deputation basis, on standard terms and conditions, with immediate effect and until further orders.

**No. F.39/1087/2019-E-I.**—Mr. Irfan Anjum, a BS-20 officer of Secretariat Group, presently posted as Joint Secretary, Interior Division, is transferred and posted as Joint Secretary, Law & Justice Division, with immediate effect and until further orders.

**No. F.15/02/2020-E-I.**—The Federal Government has been pleased to assign additional charge of the post of Chief Executive Officer (CEO), National Fertilizer Corporation (NFC), during the transition period of the organization, to Dr. Hamid Ateeq Sarwar (IRS/BS-21), Additional Secretary-II, Industries & Production Division.

**No. F.31/2/2017-E-I.**—Mr. Ghulam Mujtaba Joyo, a BS-19 officer of Secretariat Group, presently posted as Officer on Special Duty (OSD), Establishment Division, is transferred and posted as Joint Secretary (BS-20), Communication Division, under Section 10 of Civil Servants Act, 1973, with immediate effect and until further orders.

ATIF R. KHATTAK,  
Section Officer.

(Poverty Alleviation & Social Safety Division)

Islamabad, the 27th October, 2020

**No. 22(2)/2020(Org).**—In pursuance of ECC decision in Case No.ECC.187/22/2020 dated 20th May, 2020 regarding Prime Minister's COVID-19 Pandemic Relief Fund-2020, following Policy Committee has been notified with immediate effect:

- |    |   |           |
|----|---|-----------|
| 1. | Prime Minister of Pakistan                                  | Chairman  |
| 2. | Minister for Planning, Development & Special Initiatives    | Member    |
| 3. | Adviser to the PM on Finance & Revenue                      | Member    |
| 4. | Adviser to the PM on Commerce & Investment                  | Member    |
| 5. | SAPM on Poverty Alleviation & Social Safety                 | Member    |
| 6. | Prime Minister's Focal Person for Corona Philanthropy Drive | Member    |
| 7. | Secretary Finance Division                                  | Member    |
| 8. | Secretary Poverty Alleviation & Social Safety Division      | Secretary |

Terms of Reference for the Policy Committee are as under:-

- i. To decide on the appropriate usage of the proceeds deposited in the Fund including means of identification of the beneficiaries of the Fund and parameters of their selection;
- ii. To decide about the means of disbursement of assistance to the beneficiaries;
- iii. To take any appropriate decision for collection of donations, maintenance and administration of the Fund and related matters.

AHMAD JAN MALIK,  
Joint Secretary (Admn.).

Islamabad, the 27th October, 2020

**No.PASSD.SO.P.1(9)/2019 (Admn)-486.**—Consequent upon approval of the competent authority, Dr. Aqsa Munir, Section Officer (BS-17) has been granted 31 days LFP with effect from 3rd November, 2020 to 3rd December, 2020, Mr. Khalil-ur-Rehman, Section Officer (F&A) will look after the work of Planning Section during her leave period.

The officer is expected to return to the same post / station on expiry of the above leave.

Islamabad, the 28th October, 2020

**No. 32-3/2020 (Admn) 490.**—Consequent upon approval of the Secretary, the Committee for Directory Retirement from Service in respect of Civil Servants in BPS-17 to 19 has been constituted as under:-

a	Additional Secretary (BS-21), PA&SS Division	Chairperson
b	BS-20 Officer of Establishment Division	Member
c	Joint Secretary-Exp. (Poverty Alleviation & Social Safety Division) (BS-20), Finance Division	Member
d	Mr. Muhammad Israr, Additional Draftman (BS-20), M/o. Law & Justice	Member
e	Head of the Department (Not applicable)	Member
f	Deputy Secretary (A&C) (BS-19), PA&SS Division	Secretary

**No. 32-3/2020 (Admn) 491.**—Consequent upon approval of the Secretary, the Committee for Directory Retirement from Service in respect of Civil Servants in BPS-16 & below has been constituted as under:-

a	Joint Secretary (A&C) (BS-20), PA&SS Division	Chairperson
b	Mr. Muhammad Israr, Additional Draftsman (BS-20), M/o. Law & Justice	Member
c	BS-19 Officer, Establishment Division (to be nominated by Establishment Division)	Member
d	Deputy Secretary-Exp (Poverty Alleviation & Social Safety Division) (BS-19), Finance Division	Member
e	Head of the Department (Not applicable)	Member
f	Deputy Secretary (A&C) (BS-19), PA&SS Division	Secretary

GUL ZAMAN,  
Section Officer (Admn.).

[BENAZIR INCOME SUPPORT PROGRAMME]

Islamabad, the 19th November, 2020

**No. 1(908)/BISP/HR/B/2016.**—Mr. Zia-ur-Rehman, Deputy Director (Operation) SPS-18, Regional Office, BISP KP, is hereby assigned additional charge of the post of Deputy Director (HR) (SPS-18), Regional Office, BISP KP, in addition to his own duties, with effect from 23rd November, 2020, for a period of three months or till posting of a regular incumbent of the post, whichever is earlier.

This issues with the approval of the Director General (Admin. & HR), BISP.

**No. 1(1337)/BISP/HR/BAL/18.**—This Office's notification of even number dated 25th September, 2020 regarding repatriation of Mr. Manzoor Ahmed, Director (Postal Group/BPS-18), Office of Postal Life Insurance, Quetta, presently posted as Director (HQ) (SPS-19), BISP Balochistan Region, to his parent department, is hereby cancelled / withdrawn *ab-initio*.

This issues with the approval of the Secretary, BISP.

**No. 1(1335)/BISP/HR/BAL/2019.**—Mr. Zahoor Ahmed, Divisional Director, BISP Sibbi, Balochistan Region has availed 4 days leave with effect from 12th October, 2020 to 15th October, 2020. The said leave has been approved as Leave on full pay (LFP).

This issues with the approval of the Secretary BISP, Islamabad.

**No. F.1(666)/BISP/HR/KP/2015.**—Following Assistant Directors (SPS-17), Regional Office, BISP KP, are assigned additional charge of the vacant posts of Assistant Directors of BISP Tehsil Offices, KP Region, mentioned in Column-4, in addition to their own duties, for the period of three months mentioned in Column-5 or till posting of regular incumbent of the post, whichever is earlier:-

Sr.#	Name of Officers	Present place of posting	Vacant post for grant of Additional Charge	Grant of Additional Charge w.e.f.
1	Mr. Noman Zafar	Assistant Director, Tehsil Office Havelian	Assistant Director Tehsil Office Abbottabad	02-11-2020
2.	Mr. Munawar Khan	Assistant Director, Tehsil Office Judbah	Assistant Director Tehsil Office Palas/ Pattan	02-11-2020
3.	Mr. Shaheen Shah	Assistant Director, Tehsil Office, Battagram	Assistant Director, Tehsil Office, Alai	05-11-2020

2. This issues with the approval of the Director General (Admin.& HR), BISP.

Islamabad, the 20th November, 2020

**No. 1(1460)/BISP/HR/AJK/2020.**—In pursuance of BISP Head Office Islamabad's Letter No.1(42)BISP/HR/AJK/2012, dated 19th October, 2020 and in furtherance of Ministry of Railways Islamabad's Letter No.Admn-IV/ 1772-P, dated 4th November, 2020, Mr. Umar Riaz, Director (Operations) (BPS-19), Ministry of Railways Islamabad has joined Benazir Income Support Programme (BISP) Head Office Islamabad on 5th November, 2020, on deputation basis, for a period of three years, as per BISP Employees (Service) Regulations-2018.

This issues with the approval of the Secretary BISP.

Islamabad, the 25th November, 2020

**No. 1(1461)/BISP/HR/S/2020.**—In pursuance of this Office Letter No.1(42)BISP/HR/S/2018, dated 2nd December, 2019 and in furtherance of Services, General Administration and Co-Ordination Department Letter No.SOII(SGA&CD)1-9/2020, dated 19th November, 2020 and Establishment Division, Islamabad Notification No.1/355/2019-E-4, dated 26th October, 2020, Mr. Moazam Ali Rind, Statistical Officer (BPS-17), Bureau of Statistics, Planning and Development Department, Government of Sindh has joined Benazir Income Support Programme, against the post of Assistant Director (SPS-17), Sindh Region with effect from 11th November, 2020 on deputation basis, for a period of one year, in terms of BISP Employees Service Regulations-2018.

This issues with the approval of the Secretary, BISP.

**No. F.1(1461)/BISP/HR/S/2020.**—Mr. Moazam Ali Rind, Assistant Director (SPS-17), BISP Tehsil Office Dadu, Larkana Division, Sindh Region is hereby granted Additional Charge of the vacant post of Assistant Director (SPS-17), BISP, Tehsil Office Johi, Sindh Region, for a period of three months, with immediate effect, in addition to his own duties, or till appointment of a regular incumbent of the post, whichever is earlier.

This issues with approval of the Secretary, BISP.

Islamabad, the 27th November, 2020

**No. 1(1378)/BISP/HR/P/2019.**—Mr. Muhammad Shahid, Divisional Director (SPS-19), BISP, Gujranwala Division, is hereby granted current charge of the post of Director General (SPS-20), BISP, Punjab Region, from the date of relinquishment of the charge of the post by the incumbent Director General BISP Punjab, in addition to his own duties, for a period of three months or till posting of a regular incumbent of the post, whichever is earlier.

This issues with approval of the Secretary, BISP.

**No. 1(1378)/BISP/HR/P/2019.**—In pursuance of Establishment Division's Notification No.1/79/2005-E-4, dated 11th November, 2020, Mr. Bilal Majeed (PA&AS/BS-20) presently posted as Director General (SPS-20), Benazir Income Support Programme Punjab Region, on deputation basis, is hereby repatriated to his parent department, *i.e.* Office of the Auditor General of Pakistan Islamabad, with immediate effect.

This issues with the approval of the Secretary, BISP.

Islamabad, the 30th November, 2020

**No. 1(1450)/BISP/HR/AJK/2020.**—Mr. Muhammad Zaheer Khan, Divisional Deputy Director (SPS-18), BISP Divisional Office Poonch (Rawlakot) AJK Region, is attached with NSER Wing, BISP Head Office Islamabad, with effect from 3rd November, 2020, for a period of three months or till posting of a regular incumbent of the post whichever is earlier.

This issues with the approval of the Director General (Admin. & HR) BISP.

Islamabad, the 2nd December, 2020

**No. F.1(1068)/BISP/HR/KP/2017.**—Mr. Inayat Ullah Shah, Assistant Accounts Officer, BISP Divisional Office, Mardan is hereby assigned additional charge of the post of the vacant post of Assistant Accounts Officer, BISP Divisional Office, Malakand, in addition to his own duties, with immediate effect, for a period of three months or till

posting of regular incumbent of the post whichever is earlier.

This issues with the approval of the Director General (Admin. & HR) BISP.

**No. F.1(646)/BISP/HR/KP/2015.**—Mr. Sajjad Ali, Assistant Director, (SPS-17), BISP Tehsil Office, Chota Lahor, KP Region is hereby assigned additional charge of the post of Assistant Director, BISP Tehsil Office, Topi, in addition to his own duties, with effect from 16th November, 2020, for a period of thirty three (33) days during the leave period of the incumbent of the post.

This issues with the approval of the Director General (Admin. & HR) BISP.

Islamabad, the 7th December, 2020

**No. F.1(1465)/BISP/HR/S/20.**—In pursuance of BISP (HQ), Islamabad's Letter No.1(42)/BISP/HR/S/2017 dated 3rd November, 2020 and in furtherance of Office of the Controller Military Accounts, Rawalpindi Letter No.436/AN/902-242(42272), dated 13th November, 2020 & Controller, Military Accounts (Karachi Command), Karachi Letter No.G/AN/983-Tfr/AAO-Supdt/20-21, dated 18th November, 2020, Mr. Wahid Bux, Assistant Accounts Officer/ 42272, CMA, Karachi has joined BISP Regional Office, Sindh as Assistant Accounts Officer with effect from 19th November, 2020 on deputation basis for a period of three years, on standard terms & conditions.

This issues with the approval of Secretary, BISP.

**No. F.1(1464)/BISP/HR/S/20.**—In pursuance of BISP (HQ), Islamabad's Letter No.1(42)/BISP/HR/S/2017 dated 3rd November, 2020 and in furtherance of Office of the Controller Military Accounts (CMA), Rawalpindi Letter No.442/AN/902-242(25989), dated 16th November, 2020, Mr. Muhammad Abdul Malik, Senior Auditor /25989, CMA, Rawalpindi has joined BISP Regional Office, Sindh as Assistant Accounts Officer with effect from 23rd November, 2020 on deputation basis for a period of three years, on standard terms & conditions.

This issues with the approval of Secretary, BISP.

AKHTAR SAEED,  
Director HR (Regions).

Islamabad, the 23rd November, 2020

**No. F.1(930)/BISP/HR/KPK/2020.**—In partial modification of this Office notification of even number dated 10th November, 2020, the date of repatriation of

Mr. Muhammad Jehanzeb Zafar, Assistant Accounts Officer (SPS-17), BISP Divisional Office, Peshawar, to his parent department *i.e.* Accountant General, Khyber Pakhtunkhwa, may be read as 2nd November, 2020 instead of 2nd October, 2020.

This issues with the approval of the Secretary BISP.

MUHAMMAD AHMAD USMANI,  
Deputy Director (HR-III).

---

WAFAQI MOHTASIB (OMBUDSMAN)'S SECRETARIAT

Islamabad, the 24th November, 2020

**No. F.1(433)A-II/2013.**—In pursuance of this Secretariat's Notification No.3(262)A-II/2018 dated 20th October, 2020, Ms. Shamshad Roohi has assumed the charge of the post of Deputy Director (BS-18) at WMS, Head Office, Islamabad on 17th November, 2020.

This issues with the approval of Secretary, WMS.

**No. F.3(180)A-II/2019.**—The probationary period of Mr. Muhammad Zahid, Investigation Officer (BS-17) WMS, Regional Office, Bahawalpur is terminated with immediate effect.

This issues with the approval of the Hon'ble Wafaqi Mohtasib.

**No. F.3(180)A-II/2019.**—The probationary period of Mr. Imran Khan, Investigation Officer (BS-17) WMS, Regional Office, D.I. Khan is terminated with immediate effect.

This issues with the approval of the Hon'ble Wafaqi Mohtasib.

**No. F.3(180)A-II/2019.**—The probationary period of Syed Sayyar Badshah, Investigation Officer (BS-17) WMS, Regional Office, D.I. Khan is terminated with immediate effect.

This issues with the approval of the Hon'ble Wafaqi Mohtasib.

**No. F.3(180)A-II/2019.**—The probationary period of Mr. Adnan Ahmad, Investigation Officer (BS-17) WMS, Regional Office, Lahore is terminated with immediate effect.

This issues with the approval of the Hon'ble Wafaqi Mohtasib.

**No. F.3(180)A-II/2019.**—The probationary period of Mr. Ameer Muhammad, Investigation Officer (BS-17)

WMS, Regional Office, Quetta is terminated with immediate effect.

This issues with the approval of the Hon'ble Wafaqi Mohtasib.

MOINUDDIN A. SIDDIQI,  
Director (Admn.).

---

MINISTRY OF CLIMATE CHANGE

Islamabad, the 23rd November, 2020

**No. F.6(9)/2020-Admn-II-IWMB.**—In exercise of powers conferred under Section 4 of Islamabad Wildlife (Protection, Preservation, Conservation and Management) Ordinance, 1979, the Federal Government has been pleased to appoint Ms. Rina Saeed Khan, as Chairperson of the Islamabad Wildlife Management Board (IWMB) with immediate effect and till further orders.

DR. MUHAMMAD RIZWAN ASGHAR,  
Section Officer (Admn-II).

---

MINISTRY OF COMMERCE

Islamabad, the 25th November, 2020

**No. 7(23)/2017-Admn-I/MoC.**—In pursuance of Establishment Division's Notification No.8/2/2020-E-VII, dated 20th November, 2020, consequent upon her promotion and transfer, Ms. Fozia Hussain, BS-17 officer of Office Management Group, has relinquished charge of the post of Section Officer (BS-17), Ministry of Commerce, Islamabad, on 24th November, 2020, to join her new assignment as Section Officer (BS-18/Acting Charge), Finance Division, Islamabad.

MUHAMMAD IMTIAZ,  
Deputy Director (MoC).

---

MINISTRY OF COMMUNICATIONS

Islamabad, the 30th November, 2020

**No. F.4(7)/2020-Roads-I.**—In pursuance of Establishment Division's Notification No.1/317/2020-E-4 dated 20th November, 2020 the services of Syed Umar Ali Shah Banoori a BS-19 officer of Pakistan Audit & Accounts Services (PA&AS) is placed at the disposal of this Ministry for further posting in National Highway Authority as Director (Audit and Accounts) (BS-19) on standard terms and conditions of deputation for an initial period of three years with immediate effect.

JAMAL HAIDER,  
Section Officer (Roads-I).

## DEPARTMENT OF THE AUDITOR-GENERAL OF PAKISTAN

Islamabad, the 23rd October, 2020

**No. 51-Dir(A)/2-4/20.**—The Auditor-General of Pakistan has been pleased to order postings / transfers of following officers of the Pakistan Audit & Accounts Service, in the public interest with immediate effect and until further orders:-

S. No.	Name of Officers (M/s.)	From	To	Remarks
1.	Mr. Saqlain Abbas Koreja BS-19/PA&AS	Director (Audit Policy), AGP Office, Islamabad	Proceeding on 28th SMC training w.e.f. 26.10.2020 to 12.02.2021	Assigned look after charge of the post of Director (Audit Policy) to Mr. Ahmad Us Saliheen, Director (CA&E), AGP Office, Islamabad (OPS) and until further orders.
2.	Mr. Sahrif Ullah BS-19/PA&AS	Director (Defence Audit), AGP Office, Islamabad	Proceeding on 28th SMC training w.e.f. 26.10.2020 to 12.02.2021	Assigned look after charge of the post of Director (Defence Audit) to Mr. Anwar Khan, Director (PAAA), Islamabad and until further orders.
3.	Mr. Muhammad Kashif BS-19/PA&AS	Director to AGP, AGP Office, Islamabad	Proceeding on 28th SMC training w.e.f. 26.10.2020 to 12.02.2021	Additional charge of the post of Director to AGP, AGP Office, Islamabad to Mr. Afnan Alam, Director (IR&C), Islamabad in addition to his own duties and until further orders.
4.	Mr. Muhammad Umar BS-19/PA&AS	Director Commercial Audit & Evaluation (North), Lahore	Awaiting posting at Islamabad	Proceeding on 28th SMC training w.e.f. 26.10.2020 to 12.02.2021
5.	Mr. Aamir Fayyaz BS-19/PA&AS	Director (HRM), AGP Office, Islamabad	Proceeding on 28th SMC training w.e.f. 26.10.2020 to 12.02.2021	Assigned look after charge of the post of Director (HRM) AGP office, Islamabad to Mrs. Eirij Rubbani, Deputy Director (HRM), Islamabad in addition to her own duties and until further orders.
6.	Ambreen Fatima Malik (Ms). BS-19/PA&AS	Director Audit Works (Federal), Islamabad	Awaiting posting at Islamabad	
7.	Mr. Zulfiqar Khan BS-19/PA&AS	Director (Admn), AGP Office, Islamabad	Controller Military Accounts, (ISOs), MAG Office, Rawalpindi	Vice Sr. No.8
8.	Mr. Adnan Shoaib BS-19/PA&AS	Controller Military Accounts, (ISOs), MAG Office, Rawalpindi	Director (P for R Project), SSA Wing, AGP Office, Islamabad	Vice Chaudhary Nauman Zafar, who is proceeding on appointment as Director (Audit & Accounts), Pakistan High Commission, London, UK.

S. No.	Name of Officers (M/s.)	From	To	Remarks
9.	Mr. Ghazanfar Abbas BS-19/PA&AS	Repatriation from deputation as Director (Finance), Nishtar Hospital, Multan	Regional Director District Audit, Bahawalpur	Vice Syed Khadim Abbas, BS-19/PA&AS whose services are placed at the disposal of Govt. of Punjab, Lahore on deputation basis.
10.	Mr. Sammer Ahmed BS-19/PA&AS	Director (SSA) Wing, AGP Office, Islamabad	Director, Commercial Audit & Evaluation (North), Lahore	Assigned look after charge of the post of Director (SSA) Wing, AGP office, Islamabad to Mr. Kashif Haroon, Director (SSA), Islamabad in addition to his own duties and until further orders.
11.	Mr. Furqan Salabat BS-19/PA&AS	Director, Pakistan Audit & Accounts Academy, Lahore	Director Audit, Postal & Telecommunication Service, Lahore.	Vice Mr. Hyder Javed Khan Burki, BS-19/PA&AS who will proceed on 596 days LHP from the date of availing.
12.	Mr. Hyder Javed Khan Burki BS-19/PA&AS	Director Audit, Postal & Telecommunication Service, Lahore.	Awaiting posting at Lahore	Proceeding on 596 days LHP from the date of availing.
13.	Mr. Muhammad Amjad Raza BS-19/PA&AS	Director (CA&E), AGP Office, Islamabad	Director Audit Works (Federal), Islamabad	Vice Sr. No.6
14.	Mr. Muhammad Tayyab BS-18/PA&AS	Awaiting posting at the AGP Office, Islamabad	Director (Admn), AGP Office, Islamabad (OPS).	Vice Sr. No.7
15.	Mr. Aamir Ali Khan BS-18/PA&AS	Repatriation from deputation NHA, Islamabad	Director, Pakistan Audit & Accounts Academy, Lahore (OPS)	Vice Sr. No.11
16.	Mr. Ahmad Us Saliheen BS-18/PA&AS	Deputy Director Controller Accounts, CAAF AHQ, Peshawar	Director (CA&E) AGP Office, Islamabad (OPS)	Vice Sr. No.13

ZULFIQAR KHAN,  
Director (Admn.).

Islamabad, the 26th October, 2020

**No. 947-CA-III/2-3/2009/Vol-III(KW)(SI 172).**—Syed Khadim Abbas, a BS-19 officer of Pakistan Audit and Accounts Service (PA&AS) presently posted as Regional Director District Audit, Bahawalpur is transferred and his services are placed at the disposal of Government of Punjab on deputation basis for a period of three (3) years on standard terms and conditions, with immediate effect and until further orders.

MUHAMMAD TAYYAB,  
Director (Administration).

## ELECTION COMMISSION OF PAKISTAN

## MINISTRY OF ENERGY

Islamabad, the 24th November, 2020

(Petroleum Division)

**No. F.15(5)/1995-Estt-I(Vol-II).**—Mr. Tahir Hassan, Director in the office of Provincial Election Commissioner, Balochistan, Quetta is granted 17 days extraordinary leave (without pay & allowances) from 17th August, 2020 to 2nd September, 2020.

Islamabad, the 17th November, 2020

**No. 1(1)/2006-Admn.**—Pursuant to Establishment Division's Notification No.PF(961)/E-5(PAS), dated 28th October, 2020, Capt. (Retd.) Shahbaz Tahir Nadeem, a BS-19 officer of Pakistan Administrative Service (PAS) has relinquished the charge of the post of Deputy Secretary (BS-19) in this Division on 10th November, 2020.

Islamabad, the 27th November, 2020

**No. F.15(1)/1993-Estt-I(Vol-II).**—Mr. Muhammad Raziq, a BS-21 officer of this Commission, presently posted as Provincial Election Commissioner, Balochistan is granted 3 days leave on full pay from 30th November to 2nd December, 2020, alongwith prefix closed holidays falling on 28th & 29th November, 2020 with permission to leave the station.

QUTUBUDDIN,  
Deputy Secretary.

On expiry of leave, the above officer is likely to assume the charge of the same post at Quetta.

Islamabad, the 16th November, 2020

This issues with approval of the Hon'ble Chief Election Commissioner.

**No. 4(133)/2020-Admn.**—The Competent Authority has been pleased to allow Mr. Sajid Mehmood Qazi, Joint Secretary (A&CA) / BS-20, of this Division, to hold additional charge of the post of Chief Finance & Accounts Officer (CF&AO) in addition to his own duties for further period of 41 days with effect from 16th November, 2020 to 26th December, 2020.

**No. F.1(5)/1982-Estt-I(Vol-I).**—Mr. Zafar Iqbal Hussain, a BS-21 Officer of Election Commission of Pakistan presently posted as Special Secretary in Election Commission Secretariat, Islamabad is granted 14 days leave on full pay on medical grounds from 16th to 29th November, 2020 alongwith prefix closed holidays falling on 14th & 15th November, 2020.

This issues with the approval of Secretary (Petroleum Division).

MUHAMMAD BILAL KHAN,  
Section Officer (Admn.).

On expiry of leave, the above officer is likely to assume the charge of the same post at Islamabad.

This issues with approval of the Hon'ble Chief Election Commissioner.

---

MINISTRY OF FEDERAL EDUCATION &  
PROFESSIONAL TRAINING

Islamabad, the 25th November, 2020

**No. F.3(4)/2020-Estt-I.**—In continuation of this Commission's notification of even number dated 27th August, 2020, the additional charge of the vacant post of Deputy Director (Establishment-BS-18) in the office of PEC, Punjab, Lahore assigned to Mr. Muhammad Aslam, Deputy Director (Admn) of that office, is extended for a further period of three (3) months with effect from 27th November, 2020 or till regular appointment against the said post, whichever is earlier.

**No. F.1-1/2020-AEA/SO (Organization).**—In pursuance of the recommendations of 24th meeting of IPEMC, Duly endorsed by the National Coordination Committee, the following decisions are hereby conveyed for compliance:-

This issues with approval of the Hon'ble Chief Election Commissioner.

IMRAN ZAFAR,  
Deputy Director (Estt-I).

- i) All Educational Institutions (Public/Private) in ICT will switch to home-based learning (online learning / e.learning etc) with effect from 26th November, 2020 to 24th December, 2020.
- ii) The annual winter vacations will commence from 25th December, 2020 to 10th January, 2021.



iii) All educational examinations scheduled for December, 2020 will be held after 15th January, 2021.

After expiry of leave, the officer has resumed his duties on the same post at the same station.

2. This issues with the approval of Competent Authority, Ministry of FE&PT, Islamabad.

FATIMA BURKI,  
Assistant Financial Adviser (HRM-I).

IMRAN AHMAD KHAN,  
AEA/Section Officer (Organizations).

(Economic Affairs Division)

Islamabad, the 23rd November, 2020

MINISTRY OF FINANCE, REVENUE AND  
ECONOMIC AFFAIRS

(Finance Division)

[HRM WING]

Islamabad, the 25th November, 2020

**No. F.6(10)/HR-IV/2009.**—After availing 15 days rest & recreation leave with effect from 2nd November, 2020 to 16th November, 2020, Ms. Bushra Arshed, Librarian, Finance Division, Islamabad has assumed the charge of the same post at the same station on 17th November, 2020.

**No. 1(9)/EA/A-I/2018.**—Dr. Muhammad Arshad, Deputy Chief (BS-19) (Policy), is assigned with effect from 3rd November, 2020, Current Charge of the post of Chief, (BS-20) PA&D Wing, Economic Affairs Division for a period of three months (90 days) or till the availability of a regular incumbent of the post whichever is earlier. As per rules, he will be entitled to draw “Special Pay” equal to 20% of basic pay subject to a maximum of Rs.12,000/-p.m. whichever is less.

This issues with the approval of Secretary, Economic Affairs Division.

Islamabad, the 24th November, 2020

MUHAMMAD HAYAT,  
Section Officer (HR-IV).

**No. 1(10)/EA/AI/2018.**—In pursuance of Establishment Division’s Notification No.PF.1064/2011-E-VII dated 12th November, 2020 Mr. Muhammad Mudasser Ahmed, has relinquished the charge of the post of Section Officer (OMG/BS-18), Economic Affairs Division on 23rd November, 2020.

[MILITARY FINANCE WING]

Rawalpindi, the 25th November, 2020

**No. F.1-125/HRM-I/2446.**—In pursuance of Establishment Division’s Notification No.1-23/2017-E-2 dated 23rd November, 2020, Mr. Nasir Mahmood Cheema, a BS-19 Officer, DFA/Deputy Secretary, Finance Division, (Military) is relieved from his duties on 25th November, 2020 to join Naya Pakistan Housing and Development Authority (NAPHDA), Islamabad on deputation basis for a period of three years on standard terms and condition.

**No. 1(7)/EA/AI/2018.**—After availing fifty four (54) days leave on full pay from 28th September to 20th November, 2020 granted to her *vide* this Division’s notification of even number dated 28th September, 2020, Ms. Shumaila Khan, Research Officer (BS-17) (Personnel No.50342247), Economic Affairs Division has resumed charge of the same post in this Division on 23rd November, 2020 (21st & 22nd November, 2020 being Saturday and Sunday holidays).

Islamabad, the 30th November, 2020

This issues with the approval of ASMF.

**No. F.23-560/HRM-I/2447.**—Mr. Rahat Tanveer, Assistant Private Secretary of this Wing has been granted 19 days LFP with effect from 26th October, 2020 to 13th November, 2020.

**No. 1(27)/EA/AI/2020.**—In pursuance of Establishment Division’s Notification No.8/2/2020-E-VII dated 20th November, 2020, Ms. Sonia Nawaz, has relinquished the charge of the post of Section Officer (OMG/BS-18-Acting Charge) and assumed the charge of the post of Section Officer (OMG/BS-18) on regular basis in Economic Affairs Division with effect from 20th November, 2020.

SAJID HUSSAIN ABBASI,  
Section Officer (Admin-I).

Islamabad, the 24th November, 2020

**No. F.1(132)EA/Admin-II/99.**—Mr. Zahid Bashir, Stenotypist (BPS-14), Economic Affairs Division is assigned Current Charge of the post of Assistant Private Secretary (BS-16) in the office of Joint Secretary (Admin), Economic Affairs Division for a period of three months (90 days) with effect from 11th November, 2020 to 8th February, 2021 or till the availability of a regular incumbent of the post, whichever is earlier.

This issues with the approval of Secretary, EAD.

Islamabad, the 26th November, 2020

**No. 1(5)/EA/A-I/2020.**—In pursuance of Establishment Division's Notification No.8/2/2020-E-VII dated 20th November, 2020, Mr. Ahmed Noor, has relinquished the charge of the post of Section Officer (OMG/BS-18-Acting Charge) and assumed the charge of the post of Section Officer (OMG/BS-18) on regular basis in Economic Affairs Division with effect from 20th November, 2020.

KHALID MAHMOOD,  
Section Officer (Admin).

---

#### MINISTRY OF HUMAN RIGHTS

Islamabad, the 25th November, 2020

**No. F.2-32/2019-Admn.**—In pursuance of Cabinet decision dated 17th November, 2020 in Case No.892/45/2020 "Appointment of Chairperson and Members of the National Commission for Human Rights (NCHR)", the following Cabinet Committee is constituted in terms of Rule 17 of Rules of Business, 1973 to scrutinize and submit a list of eligible persons to the Prime Minister and the Leader of the Opposition in the National Assembly to complete the process under the National Commission for Human Rights (NCHR) Act, 2012.

- |      |  |          |
|------|--|----------|
| i.   | Minister for Human Rights                                | Convener |
| ii.  | Minister for Planning, Development & Special Initiatives | Member   |
| iii. | Minister for Federal Education & Professional Training   | Member   |

Islamabad, the 26th November, 2020

**No. F.1(37)/2020-Admn.**—In pursuance of this Ministry's Offer of Appointment Letter No.4(5)/2019-Admn, dated 14th July, 2020 and on acceptance of the terms and conditions, Mr. Ali Qammar Warriach S/o. Ch. Qammar Rizwan has been appointed as Network & Database Administrator (BS-17) in the project titled "Strengthening of Regional Directorate of Human Rights Lahore, Karachi, Peshawar and Quetta, Ministry of Human Rights" on two years contract basis with effect from 27th July, 2020.

The place of posting of the officer is Regional Office Humah Rights, Lahore.

This issues with the approval of the Secretary, Ministry of Human Rights, Islamabad.

MUHAMMAD DIN,  
Section Officer (Admn).

---

#### MINISTRY OF INDUSTRIES AND PRODUCTION

(Industries & Production Division)

Islamabad, the 25th November, 2020

**No. 1(80)/2020-Admn-I.**—Dr. Hamid Ateeq Sarwar, Additional Secretary-II, BS-21 Officer of Inland Revenue Service (IRS) is hereby granted 19 days Quarantine leave on full pay (LFP) with effect from 28th October, 2020 to 15th November, 2020.

**No. 1(51)/2019-Admn-I.**—Syed Mubashir Ali Shah, Assistant Chief (LED-II) Industries and Production Division is granted additional charge of the post of Assistant Chief (LED-I) with effect from 11th September, 2020 for a period of three months or till the availability of a regular incumbent whichever is earlier.

The officer is entitled to drawn special remuneration @ 20% of his basic pay subject to maximum of Rs.12000/- per month whichever is less.

This contains approval of the Secretary, Industries and Production Division.

**No. 3(22)/2020-Admn-I.**—In pursuance of Establishment Division's O.M No.5/3/2018-E-I dated 24th November, 2020, Dr. Naeem Chaudhary (BS-21/ML&CG), Sr. Joint Secretary (IID) is hereby assigned additional charge of the post of Joint Secretary (PSD) in Industries and Production Division with effect from 27th October, 2020 for a period of 03 months or till availability of regular incumbent, whichever is earlier.

The officer is entitled to draw special remuneration @ 20% of his basic pay subject to maximum up to Rs.12000/- per month whichever is less.

**No. 1(78)/2020-Admn-I.**—Mr. Tahir Pervez, Deputy Secretary is granted 14 days Quarantine leave on full pay (LFP) with effect from 12th November, 2020 to 25th November, 2020.

On expiry of leave, the officer is likely to resume duty at the same post and place.

OMER MANZOOR SHEIKH,  
Section Officer (Admn-I).

## MINISTRY OF INFORMATION &amp; BROADCASTING

(National Heritage &amp; Culture Division)

Islamabad, the 24th November, 2020

Islamabad, the 9th November, 2020

**No. 1(1)/2014-E.II(DEMP).**—On the recommendation of Departmental Promotion Committee (DPC) in its meeting held on 12th November, 2020 and with the approval of the competent authority, *i.e.* Secretary, Ministry of Information and Broadcasting, Mr. Waheed Akhtar, Field Exhibition Officer (BS-16) is promoted to the post of Assistant Director (Exhibition) (BPS-18), with effect from 12th November, 2020 in Directorate of Electronic Media & Publications (DEMP).

UZAIR AHMED,  
Section Officer (E.II).

Islamabad, the 27th November, 2020

**No. 1(12)/2020/M-II.**—Pursuant to the provisions of Section 165 & 166 of the Companies Act, 2017, the Federal Government is pleased to nominate and appoint the following as independent Directors/ *Ex-officio* Directors of the Board of Directors of Pakistan Television Corporation:-

1. Shahzada Naeem Bokhari (Independent Director/ Chairman)
2. Additional Secretary, Ministry of Information & Broadcasting (*Ex-officio* Director)
3. Director General, ISPR (*Ex-officio* Director)
4. Additional Secretary, Finance Division (*Ex-officio* Director)
5. Managing Director, Pakistan Television Corporation (*Ex-officio* Director)
6. Syed Waseem Raza (Independent Director)
7. Asghar Nadeem Syed (Independent Director)

2. The Federal Government has further approved the nomination of Shahzada Naeem Bokhari as Chairman, PTVC Board in terms of Articles 95/95-A of the Pakistan Television Corporation's Memorandum & Articles of Association. The Board of Directors will exercise its authority in this regard.

3. The Chairman is a nominee, remains at the pleasure of the Federal Government and being a nominee, without benefits or privileges of any kind, does not hold a public office nor is remotely in the service of Pakistan and his nomination has to be approved by the Board of Directors in a meeting called for this purpose, pursuant to Article 95-A of the Memorandum & Articles of Association of Pakistan Television Corporation.

HUSSAIN AHMED WAZIR,  
Deputy Director M-II.

**No. F.1(4)/2011-Admn.**—Mr. Amanullah, Deputy Director (BS-18), NH&C Division is granted current charge of the vacant post of Director (BS-19) with effect from 15th October, 2020 for a period of three months or till arrival of a regular incumbent whichever is earlier. He shall be allowed Special Pay at the prescribed rate per month as admissible under the rules / instruction.

This issues with the approval of the PAO/ Secretary, National Heritage & Culture Division.

**No. F.3(40)/2012-Admn.**—Mr. Muhammad Khalil Abbasi, Superintendent/ DDO (BS-16), National Heritage & Culture Division has been granted 120 days leave on full pay with effect from 9th November, 2020 to 8th March, 2021 on medical grounds.

2. Mr. Asad Kaleem, Assistant (BS-16) is granted current charge of the post of Superintendent (BS-16) and designated as Drawing & Disbursing Officer (DDO), NH&C Division for a period of 90 days with effect from 9th November, 2020 during leave period of the officer with financial benefits as admissible under the rules.

SHER ALAM KHAN,  
Section Officer (Admn).

Islamabad, the 23rd November, 2020

**No. F.1-5/2020-NFCH.**—The Board of Governors (BoG), National Fund for Cultural Heritage (NFCH) in exercise of its powers under Section 6(5) of the NFCH Act, 1994, (VII of 1994) hereby re-constitute the Executive Committee (EC) of NFCH for carrying out its functions to be assigned by the Board with immediate effect for a term of three years, as per the following composition:-

- |  |  |
|--|--|
| 1. Secretary, National Heritage & Culture Division       | Chairperson<br>( <i>ex-officio</i> )       |
| 2. Joint Secretary (Expenditure), Finance Division       | Member ( <i>ex-officio</i> )               |
| 3. Mr. Kaleemullah Lashari, (Archaeologist)              | Member                                     |
| 4. Mr. Saleem ul Haq, (Archaeologist/ Conservationist)   | Member                                     |
| 5. Prof. Dr. Ihsan Ali, (PhD in Archaeology)             | Member                                     |
| 6. Joint Secretary, National Heritage & Culture Division | Secretary/ Member<br>( <i>ex-officio</i> ) |

Islamabad, the 26th November, 2020

**No. F.1(4)2011-Admn.**—This Division notification of even number dated 21st October, 2020 regarding current charge of the vacant post of Section Officer (F&A) of Mr. Muhammad Manan Zafar, Accounts Assistant, NH&C Division is hereby cancelled/ withdrawn with immediate effect.

This issues with the approval of the PAO/Secretary, National Heritage & Culture Division.

ASIF KHAN,  
Section Officer.

MINISTRY OF INFORMATION TECHNOLOGY AND  
TELECOMMUNICATION

Islamabad, the 20th November, 2020

**No. F.1-183/2015-Admn.**—Consequent upon the approval of Secretary, IT, Mr. Muhammad Jamil, Drawing & Disbursing Officer (BS-18) has been assigned additional charge of the post of Section Officer (F&A), Ministry of Information Technology and Telecommunication with effect from 18th November, 2020 for a period of three (03) months or till arrival of regular incumbent whichever is earlier.

Islamabad, the 25th November, 2020

**No. F.1-244/2020-Admn.**—In pursuance of Establishment Division's Notification No.1/11/2017-E-6 dated 26th August, 2020, Mr. Ajmal Anwar Awan, is appointed as Director General (International Coordination), MP-II scale Ministry of Information Technology and Telecommunication on contract basis for a period of two (02) years with effect from 28th October, 2020.

Islamabad, the 30th November, 2020

**No. F.1-2/2020-IT.**—Consequent upon contract appointment of Mr. Kamran Ahmed, Assistant Manager (Project Support) in PPS-7 scale in the Project titled, "Project Monitoring and Digital Transformation Cell" has joined his duties with effect from 19th November, 2020 with the same terms and conditions as laid down in the original offer letter.

NASEEM AHMED KHAN ABBASI,  
Deputy Secretary (Dev).

MINISTRY OF INTER PROVINCIAL COORDINATION

(IPC Division)

Islamabad, the 24th November, 2020

**No. F.1-611/2016-Admn-I.**—With the approval of competent authority *i.e.* Sr. Joint Secretary (Admn), Ms. Misbah Azam, Research Officer (BS-17), Ministry of

Inter Provincial Coordination is granted 16-days leave on full pay (LFP) from 19th November, 2020 to 4th December, 2020.

After expiry of leave, the officer is expected to report for duty on the same post and same station.

Islamabad, the 27th November, 2020

**No. F.1(681)/2020-Admn-I.**—In pursuance of Establishment Division's Notification No.PF.(577)/E-5(PAS) dated 26th November, 2020, Mr. Mohsin Mushtaq Chandna (BS-21/Pakistan Administrative Service) has assumed the charge of the post of Additional Secretary (Incharge) (BS-21), in Ministry of IPC on 27th November, 2020.

FARHAN AKHTAR,  
Section Officer (Admn-I).

MINISTRY OF KASHMIR AFFAIRS AND  
GILGIT-BALTISTAN

[GILGIT-BALTISTAN COUNCIL SECRETARIAT]

Islamabad, the 17th November, 2020

**No. P.F.3/3-AA-Admn(GBC).**—Mr. Aftab Ahmad Assistant Private Secretary (BS-16) Gilgit-Baltistan Council, Islamabad was appointed on contract basis on 18th October, 2012 and his contract period was extended on yearly basis upto 17th October, 2020. Now the competent authority has not further extended his contract period. He is relieved from his duties immediately.

M. ASHRAF SULTAN,  
Section Officer (Admn).

Islamabad, the 25th November, 2020

**No. 1(14)-SA/2015/F-II-GBC.**—Consequent upon the recommendations of Departmental Promotion Committee (DPC), the Secretary-in-charge Gilgit-Baltistan Council being the appointing authority has been pleased to promote the following Junior Auditors (BS-11) to the posts of Senior Auditors (BS-16) in the office of Accountant General Gilgit-Baltistan with immediate effect.

- 1) Mr. Ghulam Mehdi
- 2) Mr. Fida Ali
- 3) Mr. Faraz Ahmed
- 4) Mr. Ikramullah
- 5) Mr. Imran Shah
- 6) Mr. Muhammad Wasif

2. They will be on probation for initial period of one year.

LALAHUKH DHAR,  
Section Officer (Finance-II).

## MINISTRY OF LAW AND JUSTICE

Islamabad, the 23rd November, 2020

**No. F.25(10)/2014-A-VI.**—Ms. Sumaira Qasim, Assistant Private Secretary (BPS-16), Ministry of Law and Justice is granted 90 days leave on full pay from 2nd November, 2020 to 30th January, 2021.

After expiry of leave, the officer is likely to resume her duty on 1st February, 2021 (31st January, 2021 being closed holiday) at the same post and station.

Islamabad, the 24th November, 2020

**No. F.25(148)/2008-A-VI.**—Mr. Umar Anwar, Assistant Private Secretary (BPS-16), Ministry of Law and Justice has joined his duties on 17th November, 2020 after availing 10 days leave on full pay from 4th November, 2020 to 13th November, 2020 (14th November, 2020 and 15th November, 2020 being closed holidays) at the same post and station.

**No. F.25(44)/2012-A-VI.**—Mr. Arshad Mahmood Abbasi, Assistant Private Secretary (BPS-16), Ministry of Law and Justice is granted 60 days leave on full pay from 30th November, 2020 to 28th January, 2021.

After expiry of leave, the official is likely to resume his duties on 29th January, 2021 at same post and station.

Islamabad, the 30th November, 2020

**No. F.25(68)/2017-A-VI.**—Mr. Muhammad Saqib Ikram, translator (BPS-16), Ministry of Law and Justice has joined his duties on 24th November, 2020 after availing 15 days R&R leave on full pay from 9th November, 2020 to 23rd November, 2020 at the same post and station.

ARSHAD ALI SIDDIQUI,  
Section Officer.

—————  
[DEVELOPMENT WING]

Islamabad, the 25th November, 2020

**No. F.11(1)/2020-SPMU-DW(Admn).**—In pursuance of Ministry of Law and Justice, Development Wing's Office Order No.F.11(1)/2020-SPMU-DW(Admn) dated 16th November, 2020 Mr. Muhammad Moazzam Warraich has assumed the charge of the post of Senior Planning Officer (PPS-09) in Project titled "Strengthening of Planning and Monitoring unit in Ministry of Law and Justice Islamabad" with effect from 17th November, 2020.

This issues with approval of Secretary Law and Justice Division.

**No. F.11(2)/2020-SPMU-DW(Admn).**—In pursuance of Development Wing, Ministry of Law and Justice Offer of appointment *vide* Letter No.F.5(235)/2020-DW dated

2nd November, 2020 Mr. Muhammad Usman Arshad has assumed the charge of the post of Admin & Accounts Officer (PPS-07) in Project titled "Strengthening of Planning and Monitoring unit in Ministry of Law and Justice Islamabad" with effect from 16th November, 2020.

MUHAMMAD IJAZ GHANI,  
Joint Secretary (Dev.).

—————  
[LAW AND JUSTICE COMMISSION OF PAKISTAN]

Islamabad, the 26th November, 2020

**No. F.12/17/80/LJC-A.**—In terms of sub-rule (2A) of Rule 18-A of the Revised Leave Rules, 1980, the competent authority has been pleased to allow encashment of 365 days leave preparatory to retirement (LPR) in favour of Mr. Murtaza Khan, Superintendent (BPS-17), Law and Justice Commission of Pakistan with effect from 29th July, 2020 to 28th July, 2021 (A/N).

Mr. Murtaza Khan, Superintendent (BPS-17) shall stand retired from Government Service on 28th July, 2021 (A/N) on attaining the age of superannuation *i.e.* 60 years.

This issues with approval of the competent authority.

ADNAN RASOOL LARIK,  
Deputy Secretary (Admin).

## MINISTRY OF MARITIME AFFAIRS

Islamabad, the 26th October, 2020

**No. F.1(1)/2020-Admn.**—In pursuance of Finance Division's Office Memorandum No.19(55)legal-II/2010-1055 dated 23rd December, 2011 and on the recommendations of Departmental Promotion Committee (DPC), the Secretary, Ministry of Maritime Affairs, being the competent authority has been pleased to approve the grant of BS-18 to Mr. Muhammad Shahid, Private Secretary (BS-17), Ports & Shipping Wing, Karachi with effect from 3rd September, 2020.

Islamabad, the 26th November, 2020

**No. F.1(1)/2019-PNSC.**—In pursuance of the Federal Cabinet decision in Case No.929/Rule-19/2020 dated 25th November, 2020, Mr. Shakeel Ahmed Mangnejo (PAS, BS-21) presently posted as Director/ Chairman, Pakistan National Shipping Corporation, Karachi under Ministry of Maritime Affairs is appointed as member on the Board of Directors of Pakistan National Shipping Corporation with effect from 4th December, 2020 for a period of three (03) years in terms of Section 14 of PNSC Ordinance, 1979 read with Section 15(1) of the said Ordinance.

**No. F.1(1)/2019-PNSC.**—In pursuance of the Federal Cabinet decision in Case No.929/Rule-19/2020 dated 25th November, 2020, Mr. Imdad Ullah Bosal (PAS, BS-21) presently posted as Additional Secretary (Expenditure),

Finance Division is appointed as member on the Board of Directors of Pakistan National Shipping Corporation with effect from 26th November, 2020 for a period of three (03) years in terms of Section 14 of PNSC Ordinance, 1979 read with Section 15(1) of the said Ordinance.

Islamabad, the 30th November, 2020

**No. F.1(1)/2019-PNSC.**—In continuation to this Ministry's notification of even number dated 26th November, 2020, Mr. Imdad Ullah Bosal (PAS, BS-21) Additional Secretary (Expenditure), Finance Division has replaced Mr. Sohail Rajput, *ex-Additional Secretary*, Finance Division on the Board of Pakistan National Shipping Corporation (PNSC).

KHIZAR SALEEM KHOKHAR,  
Deputy Secretary-I.

Islamabad, the 24th November, 2020

**No. F.1(1)/2019-IT.**—Owing to transfer of Mr. Muhammad Azhar, Chief Finance & Accounts Officer (CF&AO), and upon joining of Mr. Ghulam Mustafa Samon as Chief Finance & Accounts Office (CF&AO) in this Ministry, the Competent Authority has been pleased to appoint Mr. Ghulam Mustafa Samon, CF&AO as Project Director of Development of ICT Infrastructure Project in the Ministry of Maritime Affairs, as envisaged in PC-I.

HAMEED ULLAH KHAN KHATTAK,  
Section Officer (Admn).

[PORTS & SHIPPING WING]

Karachi, the 2nd November, 2020

**No. 10(6)/1984-Estt(Vol-I)**—In pursuance of Government of Pakistan, Ministry of Maritime Affairs, Islamabad's Notification No.1(1)/2020-Admn, dated 26th October, 2020, Mr. Muhammad Shahid, has relinquished the charge of the post of Private Secretary (BS-17) and assumed the charge of the post of Private Secretary (BS-18) in the office of Ports and Shipping Wing under Ministry of Maritime Affairs, Karachi with effect from 3rd September, 2020.

Karachi, the 5th November, 2020

**No. 13(5)/2013-Estt.**—With the approval of competent authority, Ms. Tahreem Fatima, Section Officer (F&A), Ports and Shipping Wing, Ministry of Maritime Affairs, Government of Pakistan, Karachi has been granted *ex-post-facto* approval of 09 days leave on full pay with effect from 24th September, 2020 to 2nd October, 2020 (both holidays inclusive).

**No. 10(4)/2017-Estt.**—With the approval of competent authority, Mr. Azeem Sarwar, Section Officer (P-II), Ports and Shipping Wing, Karachi has been granted *ex-post-facto*

approval of 12 days leave on full pay (LFP) with effect from 28th September, 2020 to 9th October, 2020.

Karachi, the 9th November, 2020

**No. 10(6)/1984-Estt(Vol-I).**—With reference to his option for fixation of pay with effect from 2nd December, 2020 on grant of BS-18 with effect from 3rd September, 2020, after allowing annual increment in his previous pay scale (BS-17) in pursuance of Finance Division (Regulation Wing) Islamabad O.M. No.F.3(18)/R-2/99, dated 27th November, 1999 read with Finance Division O.M No.F.3(2)Gaz.Imp.I/75, dated 14th October, 1975, the competent authority has been pleased to grant the fixation of pay and allowances with effect from 2nd December, 2020 in supersession of Notification No.10(6)/1984-Estt(Vol-I), dated 2nd November, 2020 to Mr. Muhammad Shahid, Private Secretary (BS-18), Ports and Shipping Wing under Ministry of Maritime Affairs, Government of Pakistan, Karachi.

ALI MUHAMMAD,  
Section Officer (Estt).

MINISTRY OF NATIONAL FOOD SECURITY AND  
RESEARCH

Islamabad, the 18th November, 2020

**No. F.3-3/87-Admn-I.**—Mrs. Razia Jehangir, APS (BS-16) is entrusted the current charge of the post of Confidential Branch in the Ministry of National Food Security and Research with effect from 17th November, 2020 for a period of three (03) months or till the availability of regular incumbent of the post, whichever is earlier.

This issues with the approval of the Secretary, Ministry of National Food Security and Research.

**No. F.1-1/2017(PBRR)FSC&RD-Admn-II.**—Following officers from Ministry of National Food Security & Research and FSC&RD have been assigned Current /Additional Charge of the posts mentioned against each with immediate effect in addition to their own duties for a period of 60 days or till posting of regular incumbents whichever is earlier:-

S. No.	Name of Officers	Charge of the Post
1	Mr. Afaq Ahmed Director, FSC&RD	Registrar, PBRR (Current Charge Basis)
2	Mr. Tahir Mehmood Qureshi, Deputy Secretary (Admn), MNFS&R Division	Director, PBRR (Additional Charge (Basis))

S. No.	Name of Officers	Charge of the Post
3	Mr. Farhat Mushtaq Malik Section Officer (Admn-II), MNFS&R Division	Deputy Director, PBRR (Current Charge Basis)

2. This issues with the approval of Secretary, NFS&R, Islamabad.

TAHIR MEHMOOD QURESHI,  
Deputy Secretary.

Islamabad, the 19th November, 2020

**No. F.1-2/2013-Admn-II.**—Consequent upon completion of his appointment period for the post of Advisor/ Director General (BS-20), Department of Plant Protection, Karachi on contract basis for a period of two years, Dr. Falak Naz an employee of PARC has relinquished the charge of the post of Advisor/ Director General (BS-20), Department of Plant Protection, Karachi with effect from 23rd October, 2020 (FN) to resume his parent department *i.e.* PARC.

This issues with the approval of Secretary, Ministry of National Food Security & Research.

FARHAT MUSHTAQ MALIK,  
Section Officer (Admn-II).

[FEDERAL WATER MANAGEMENT CELL]

Islamabad, the 27th November, 2020

**No. F.1-4/95-Estt(WM).**—Consequent upon the approval of Director General, Federal Water Management Cell, Ministry of National Food Security & Research, Mr. Zahid Hussain Qazi, Assistant Water Management Engineer (BS-17), Federal Water Management Cell is granted thirteen (13) days leave on full pay with effect from 13th November, 2020 to 25th November, 2020.

On expiry of above leave, he has resumed his duty on the same post and station.

TEHMEENA IQBAL,  
Research Officer (Admn).

MINISTRY OF NATIONAL HEALTH SERVICES,  
REGULATIONS & COORDINATION

Islamabad, the 11th November, 2020

**No. F.10(11)AR/2018-(Admn-I).**—Mr. Ali Raza, Section Officer (General) (BS-18), Ministry of National Health

Services, Regulations and Coordination (NHSRC) is granted 120 days leave on full pay with effect from 6th November, 2020 to 7th March, 2021.

This issues with the approval of the Additional Secretary, Ministry of National Health Services, Regulations and Coordination, Islamabad.

**No. F.11(68)/RMS/2019-(Admn-I).**—Mr. Rashed Munir Shahzad, Section Officer (BS-18), Ministry of National Health Services, Regulations and Coordination (NHSRC) is granted 21 days leave on full pay (LFP) with effect from 17th September, 2020 to 7th October, 2021.

Mr. Rashed Munir Shahzad, has assumed the charge of the post of Section Officer (BS-18) with effect from 8th October, 2020 after availing 21 days LFP on medical grounds.

**No. F.10(11)/AR/2018-(Admn-I).**—Mr. Zuhaib Hassan Shaikh, Section Officer (Admn-IV), Ministry of National Health Services, Regulations and Coordination is assigned additional charge of the post of Section Officer (General) with effect from 6th November, 2020 for a period of three months or till posting of a regular incumbent, whichever is earlier.

This issues with the approval of the Additional Secretary, Ministry of National Health Services, Regulations and Coordination, Islamabad.

FARHAN SIKANDAR,  
Section Officer (Admn-I).

Islamabad, the 12th November, 2020

**No. F.1-12/2017-FGH-H-III.**—In partial modification of this Ministry's notification of even number dated 17th September, 2020 and with the approval of the competent authority, Mrs. Qurat-ul-Ain, Head Nurse (BS-17), Federal General Hospital, Islamabad is granted two years ex-Pakistan extraordinary leave (leave without pay) with effect from 1st October, 2020 to 30th September, 2022.

IMRAN ALI,  
Section Officer (T-IV).

[DRUG REGULATORY AUTHORITY OF PAKISTAN]

Islamabad, the 10th November, 2020

**No. F.1-15/2020-Admn-1.**—In pursuance of Federal Board of Revenue (Customs Wing)'s O.M No.C.1(8)/PMO (NSW)/2018/PT-I dated 8th October, 2020, the Competent Authority *i.e.* Chief Executive Officer, DRAP has been pleased to nominate Mr. Ishtiaq Shafiq, Assistant Director

(RO-12), Drug Regulatory Authority of Pakistan for attachment with the PMO (PSW), FBR for a period of 06 months with immediate effect and until further orders.

**No. PF.42-SY/Admn-II.**—In pursuance of Drug Regulatory Authority of Pakistan's notification of even number dated 16th October, 2020, Mst. Sidra Yasmeen, Assistant Director (RO-12), Drug Regulatory Authority of Pakistan, Karachi was granted 5 days leave with full pay (LFP) with effect from 19th October, 2020 to 23rd October, 2020, with permission to leave the station.

After availing the said leave, the officer concerned has resumed her duties with effect from 26th October, 2020 on the same post and at the same station (Being public holidays on 24th October, 2020 & 25th October, 2020).

Islamabad, the 11th November, 2020

**No. PF.1693-AR/Admn-I(PT-II).**—In pursuance of Drug Regulatory Authority of Pakistan, Islamabad's Office Order No.F.6-6/2011-Admn-I(PT-II) dated 10th November, 2020, Dr. Abdur Rashid, Additional Director (BS-19), DRAP, Islamabad has assumed the charge of the post of Director, Pharmacy Services Division, DRAP, Islamabad on 10th November, 2020 in his own pay & scale, in addition to his own duties for a period of three (03) months on look after basis.

**No. PF.1702-AH/Admn-I(Vol-II).**—In pursuance of Drug Regulatory Authority of Pakistan, Islamabad's Office Order No.F.6-6/2011-Admn-I(PT) dated 9th November, 2020, Mr. Abdullah, Deputy Director (RO-13), DRAP, Islamabad has assumed the charge of the post of Additional Director, Pharmaceutical Evaluation & Registration Division, DRAP, Islamabad on 9th November, 2020 in his own pay & scale, in addition to his own duties for a period of three (03) months on look after basis.

Islamabad, the 13th November, 2020

**No. PF.58-MU/Admn-I.**—Mr. Muhammad Usman, Assistant Director (RO-12), Drug Licensing Division, Drug Regulatory Authority of Pakistan, Islamabad has been granted 15 days Rest and Recreation leave in lieu of 10 days leave with full pay with effect from 21st November, 2020 to 4th December, 2020 with permission to leave the station.

After expiry of the said leave, the officer concerned is expected to resume his duty on the same post and at the same station.

This issues with the approval of the competent authority.

ASMAT ULLAH,  
Assistant Director (Admin-I).

MINISTRY OF NARCOTICS CONTROL

Islamabad, the 24th November, 2020

**No. 2-12/95-ANF.PA-29183.**—Brig. Mansoor Ahmed has relinquished the charge of the post of Director (BS-20), Regional Directorate Anti Narcotics Force Sindh with effect from 31st October, 2020.

**No. F.2-39/2009-ANF.**—In light of recommendations of FR-17(1) Committee meeting held on 17th September, 2020, conveyed by Finance Division *vide* Letter No.1(5)/2020.FR-17 dated 13th November, 2020, Mr. Ali Gohar Baladi, Senior Private Secretary (BS-19), ANF is granted ante dated promotion in BS-17 from 25th December, 2010 instead of 6th March, 2012 for payment of arrears of pay and allowances.

MUHAMMAD HASSAN ABDULLAH,  
Section Officer (ANF).

Islamabad, the 20th November, 2020

**No. F.1-4/2010-Admn.**—In light of FST, Islamabad's Judgment No.2875 dated 14th May, 2013 in Appeal No.1420(R)CS/2012, the Secretary, MNC has been pleased to allow Syed Abul Hassan Shamsi, Senior Private Secretary (BS-19), now retired, antedated promotion as Private Secretary (BS-17) with effect from 16th March, 2010, instead of 9th August, 2011 with all consequential benefits.

SYED SAADAT ALI BOKHARI,  
Section Officer (Admn).

MINISTRY OF OVERSEAS PAKISTANIS & HUMAN  
RESOURCE DEVELOPMENT

Islamabad, the 19th November, 2020

**No. 9-39/2018-Emig-I.**—On the recommendations of Director General, Bureau of Emigration and Overseas Employment (BE&OE), Islamabad, the Competent Authority *i.e.* Secretary, Ministry of Overseas Pakistanis & Human Resource Development has been pleased to accord approval of 61 days leave with full pay (LFP) with effect from 28th December, 2020 to 26th February, 2021 to Mr. Muhammad Israr, Assistant Director (BS-17), Bureau of Emigration & Overseas Employment, Islamabad subject to title.

**No. 9-23/2018-Emig-I.**—On the recommendations of Director General, Bureau of Emigration and Overseas Employment (BE&OE), Islamabad, the Competent Authority *i.e.* Secretary, Ministry of Overseas Pakistanis & Human Resource Development has been Pleased to grant approval of 19 days L.F.P with effect from 25th January, 2021 to



12th February, 2021 instead of 30th November, 2020 to 18th December, 2020 to Mr. Muhammad Ali Solangi, Assistant Director (BS-17), BE&OE (HQs) subject to title.

SHAZIA NAUREEN,  
Section Officer (Emig-I).

Islamabad, the 19th November, 2020

**No. 4-4/2018-Admn-I.**—On the recommendation of the Departmental Promotion Committee (DPC-I) of this Ministry and with the approval of Secretary, M/o. OP&HRD being Appointing Authority, in terms of Rule 6 of (Appointment, Promotion and Transfer) Rules, 1973, and in pursuance of Establishment Division's O.M. No.1/9/80-R-2 dated 2nd June, 1983 *proviso* (iii) and O.M. No.1/3/2008-R-6 dated 18th August, 2015, Syed Abid Hussain Shah, Private Secretary (BS-18) has been granted time scale promotion to BS-19 with immediate effect.

He is placed on probation under the provision of Civil Servants Act, 1973.

**No. 4-4/2018-Admn-I.**—On the recommendation of the Departmental Promotion Committee (DPC-I) of this Ministry and with the approval of Secretary, M/o. OP&HRD being Appointing Authority, in terms of Rule 6 of (Appointment, Promotion and Transfer) Rules, 1973, and in pursuance of Establishment Division's O.M. No.1/9/80-R-2 dated 2nd June, 1983 *proviso* (iii) and O.M. No.1/3/2008-R-6 dated 18th August, 2015, the following Private Secretaries (BS-17) have been granted BS-18, with immediate effect:-

- i) Mr. Muhammad Ashraf.
- ii) Mr. Muhammad Noor ul Ain,

2. They are placed on probation under the provision of Civil Servants Act, 1973.

RAJA SHAHROZE ABBAS,  
Section Officer (Admn-I).

Islamabad, the 19th November, 2020

**No. F.1(10)/2016-CWA-I.**—Mrs. Saulat Saqib (PAS/BS-19) has relinquished the charge of the post of Community Welfare Attache in the Consulate General of Pakistan, Dubai in the afternoon of October 19, 2020. The officer is directed to report to the Establishment Division for further posting.

JUNAID AFZAL,  
Section Officer (CWA-I).

MINISTRY OF PARLIAMENTARY AFFAIRS

Islamabad, the 23rd November, 2020

**No. F.25(11)/2018-PA(Admn).**—Ms. Aqsa Jamal, Section Officer (BS-17), Ministry of Parliamentary Affairs is granted 90 days leave on full pay from 30th November, 2020 to 27th February, 2021 with permission to leave the station.

On expiry of the leave, the officer shall resume his duty on the same post and at the same station, on due date.

HAFEEZULLAH KHAN,  
Section Officer (Admn).

MINISTRY OF PLANNING, DEVELOPMENT AND  
SPECIAL INITIATIVES

Islamabad, the 16th November, 2020

**No. 7(27)EG/HRM.II/PD/2011.**—In pursuance of this Ministry's Notification No.7(24)EG/HRM-II/PD/2011 dated 12th November, 2020, Mr. Abdul Ahad has relinquished charge of the post of Assistant Chief (BS-18), Economists Group, in Ministry of Planning, Development & Special Initiatives with effect from 12th November, 2020.

Islamabad, the 18th November, 2020

**No. 9(13)EG/HRM.II/PD/2005.**—Dr. Naila Jabeen, Deputy Chief (BS-19), M/o. Planning, Development & Special Initiatives is granted 60 days leave on full pay with effect from 14th November, 2020 to 12th January, 2021 on medical grounds, subject to title under the Revised Leave Rules, 1980.

She is likely to resume charge of her post in this Ministry after expiry of the above leave.

**No. 7(7)EG/HRM.II/PD/2011.**—Ms. Mahjabeen Cheema, Assistant Chief (BS-18), M/o. Planning, Development & Special Initiatives is granted 15 days leave on full pay with effect from 4th November, 2020 to 18th November, 2020 on medical grounds, subject to title under the Revised Leave Rules, 1980.

She is likely to resume charge of her post in this Ministry after expiry of the above leave.

**No. 9(27)EG/HRM.II/PD/2010.**—Dr. Hanan Ishaque, Assistant Chief (BS-18), M/o. Planning, Development & Special Initiatives is granted 30 days leave on full pay with effect from 18th November, 2020 to 17th December, 2020, subject to title under the Revised Leave Rules, 1980.

He is likely to resume charge of his post in this Ministry after expiry of the above leave.

SEHRISH GHAYAS,  
Section Officer (HRM-II).

[PLANNING COMMISSION]

Islamabad, the 17th November, 2020

**No. 7(120)HRM-III/PD&SI/2018.**—Mr. Attiq-ur-Rehman, Accounts Officer (BS-18), Ministry of Planning, Development and Special Initiatives is allowed to hold additional charge of the vacant post of Section Officer (Pension), Ministry of Planning, Development and Special Initiatives in addition to his own duties with immediate effect for a period of 90 days or till joining of regular incumbent, whichever is earlier.

This issues with the approval of Secretary, Ministry of Planning, Development & Special Initiatives.

AMBREEN MAZHAR,  
Section Officer.

Islamabad, the 16th November, 2020

**No. 2(3-10)HRM.I/PDSI/07.**—Consequent upon his selection by the Federal Public Service Commission and upon acceptance of terms and conditions of the post offered to him *vide* this Ministry's Memorandum of even number dated 4th November, 2020, the competent authority has been pleased to appoint Mr. Muhammad Muzzammil Hussain as Assistant Chief (BS-18), Devolution and Area Development Section, Ministry of Planning, Development & Special Initiatives, Islamabad with effect from 6th November, 2020 on temporary basis.

Mr. Muhammad Muzzammil Hussain has assumed charge of the post of Assistant Chief (BS-18), Devolution and Area Development Section, Ministry of Planning, Development & Reform on 6th November, 2020 after being relieved from Ministry of Overseas Pakistanis and Human Resource Development *vide* their Notification No.9-11/2016-Emig-I dated 5th November, 2020.

The officer will be on probation for a period of one year with effect from 6th November, 2020, extendable by an order for a further period not exceeding 12 months with effect from the date of the completion of his earlier probation period.

SAEED AHMED RAHOOJO,  
Section Officer (HRM-I).

MINISTRY OF RAILWAYS

[RAILWAY BOARD]

Islamabad, the 12th November, 2020

**No. F.5/85-3/1995-A-I.**—Mr. Abdul Hameed Razi, a BS-22 Officer is Railways (Commercial & Transportation) Group, presently working as Member (Incharge) (BS-22),

Wafaqi Mohtasib (Ombudsman)'s Secretariat, Regional Office, Lahore on deputation basis shall stand retired from Government Service on attaining the age of superannuation with effect from 2nd January, 2021.

**No. 6/2-2/2020-A-I.**—Mr. Zulfiqar Shaikh, a BS-18 Officer of Mechanical Engineering Department, presently working as Senior Mechanical Engineer/DS, Pakistan Railways, Hqs. Office, Lahore is transferred and posted as Deputy Chief Mechanical Engineer/DSM (BS-19), Pakistan Railways, Hqs. Office, Lahore, in his own pay and scale, with immediate effect *vice* vacancy.

This issues with the approval of Secretary/Chairman Railways.

**No. 5/372-1/2020-A-I.**—Following Officers of Pakistan Railways, presently under suspension with effect from 9th May, 2020 are hereby released from suspension with immediate effect.

- i) Mr. Anwar-ul-Haq, *Ex-Divisional* Mechanical Engineer (BS-18)/ Freight, Karachi
- ii) Mr. Ghulam Qadir Lakho, *Ex-Divisional* Engineer-II (BS-18/OPS)/ Karachi.

2. This issues with the approval of Secretary/Chairman Railways.

SHAHZAD ZAREEF,  
Deputy Director /Admn-I.

Islamabad, the 12th November, 2020

**No. 3/2-Med/08-A-II.**—On the recommendations of Departmental Promotion Committee (DPC), the Competent Authority (Secretary/ Chairman Railways), under Rule-6 of the Civil Servants (Appointment, Promotion & Transfer) Rules, 1973, has been pleased to approve the promotion of Dr. Fatima Basharat, Medical Officer (Dental) (BS-17) Medical Department (Specialist Cadre) of Pakistan Railways as Dental Surgeon (BS-18) with immediate effect on regular basis against 50% promotion quota.

WAQAR AHMED,  
Deputy Director /Admn-II.

Islamabad, the 12th November, 2020

**No. F.Admn-IV/10-TR/1.**—With immediate effect Mr. Waris Ali, a BS-19 Officer of General Administration, Ministry of Railways, presently working as Director/ Administration (BS-19), Ministry of Railways, Islamabad, is appointed as Joint Secretary (BS-20), Ministry of Railways,

Islamabad on current charge basis initially for a period of three months or till the availability of regular incumbent whichever is earlier.

This issues with the approval of the Secretary/ Chairman Railways.

**No. Admn-IV/10-TR/1.**—In pursuance of this Ministry's Notification No.Admn-IV/10-TR/1 dated 12th November, 2020, Mr. Waris Ali, a BS-19 Officer of General Administration, Ministry of Railways presently working as Director/ Administration (BS-19) has assumed the charge of the post of Joint Secretary (BS-20), Ministry of Railways, Islamabad on current charge basis with effect from 12th November, 2020.

FAHEEM AHMED MALIK,  
Assistant Director/ Admn-IV.

---

MINISTRY OF RELIGIOUS AFFAIRS AND  
INTERFAITH HARMONY

Islamabad, the 17th November, 2020

**No. F.2(12)/2020/Admn-IH.**—Consequent upon recommendation of the Departmental Promotion Committee and with the approval of Competent Authority *i.e.* Additional Secretary, RA&IH, Mr. Fayyaz Ahmed, Stenotypist (BS-14) is hereby promoted to the post of Assistant Private Secretary (BS-16) with immediate effect and until further orders.

He will be on probation for a period of one year, extendable for a further period of one year in terms of rule 21 of the Civil Servants (Appointment, Promotion and Transfer) Rules, 1973.

SYED IFTIKHAR AHMED,  
Section Officer (Admn-IH).

Islamabad, the 18th November, 2020

**No. 12(77)/2018-FA.**—Mr. Abdul Wahid, Liaison Officer (BS-16), Directorate of Hajj, Karachi shall stand retired from Government Service on attaining the age of superannuation *i.e.* 60 years with effect from 13th December, 2020.

This issues with the approval of Additional Secretary, Ministry of Religious Affairs and Interfaith Harmony, Islamabad.

ABID SAEED,  
Section Officer (HA).

Islamabad, the 16th November, 2020

**No. F.10(1)/DD(Q)/2016.**—In pursuance of the decision of the Central Ruet-e-Hilal Committee, in its meeting held today at Karachi, the Federal Government in the Ministry of Religious Affairs and Interfaith Harmony hereby announce that the Moon of Rabi-ul-Sani 1442 AH has sighted, therefore the 1st Rabi-ul-Sani 1442 AH shall commence from Tuesday, the 17th November, 2020.

HAFIZ ABDUL QUDOOS,  
Director (R&R).

[DIRECTORATE OF HAJJ]

Islamabad, the 16th November, 2020

**No. 2(7)/2008-A&E.**—Mr. Muhammad Nawaz Nagra, Assistant Private Secretary (BPS-16), Directorate of Hajj, Islamabad has assumed the charge of the post of Assistant Private Secretary (BPS-16) on 16th November, 2020 after availing 12 days leave on full pay with effect from 2nd November, 2020 to 13th November, 2020 and sufficing of closed holidays fallen on 14th & 15th November, 2020 (Saturday and Sunday).

HASEEB AHMED SIDDIQUI,  
Director (Hajj).

---

MINISTRY OF SCIENCE & TECHNOLOGY

Islamabad, the 17th November, 2020

**No. 3(12)/2019-Estt-II.**—With the approval of Additional Secretary, Ministry of Science & Technology, Syed Nasir Masroor, Section Officer (F&A) BS-17 of this Ministry is assigned additional charge of the post of Section Officer (Estt) (BS-17) in addition to his own duties with effect from 17th October, 2020 or till joining of the incumbent of the post.

SYED SHAFQAT HUSSNAIN SHAH,  
Section Officer.

---

NATIONAL ASSEMBLY SECRETARIAT

Islamabad, the 30th December, 2020

**No. 19(7)/2016/Estt.I(190).**—In pursuance of Pakistan Institute for Parliamentary Services Letter No.PF.14-MMK/2012-PIPS dated 24th December, 2020, Mr. Muhammad Maqbool Khan, Director General Capacity

Building and Development (BS-20), is appointed to the post of Director General (Media) (Kashmir Committee) (BS-20), in the National Assembly Secretariat on deputation basis on usual terms and conditions in his own pay and scale with immediate effect.

This issues with the approval of the competent authority *i.e.* Honourable Speaker.

**No. G(294)/E-I(191).**—The competent authority has been pleased to terminate the probation period of Mr. Muhammad Yaseen Saleemi, Deputy Secretary (BS-19) under section 8(4) of the National Assembly Secretariat Employees Act, 2018 with effect from 23rd December, 2020.

SHEHRYAR KHAN,  
Section Officer.

---

SENATE SECRETARIAT

Islamabad, the 28th December, 2020

**No. G(278)/2020-HRM(193).**—In continuation of the Senate Secretariat, Islamabad, Notification No.F.3(8)/2018-HRM(32) dated 14th February, 2020, the competent authority has been pleased to extend deputation period of Mr. Sarfraz Yousaf, Assistant Director (Protocol) (BPS-17), the Senate Secretariat Islamabad, for a period of one year, on standard terms and conditions, in the Senate Secretariat, Islamabad, with effect from 10th February, 2021.

He will be entitled to draw deputation allowance @ 20% of his basic pay, subject to a maximum of Rs.12,000/- per month.

This issues with the approval of the Chairman Senate.

**No. F.3(2)/2020-HRM(188).**—The competent authority has been pleased to appoint of Mr. Abdul Qayyum S/o. Ghulam Muhammad against the post of Assistant Protocol Officer (BPS-16) on contract basis, without advertisement under Rule-17 of Senate Secretariat (Service) Rules, 2017 for a period of 10 weeks *i.e.* 8th December, 2020.

The other terms and conditions of his appointment will be the same as conveyed to him *vide* the Senate Secretariat's Letter No.F.3(2)/2020-HRM, dated the 3rd December, 2020.

This issues with the approval of Chairman Senate.

ZAHOO AHMED,  
Section Officer (HRM).

SUPREME COURT OF PAKISTAN

Islamabad, the 21st December, 2020

**No. F.24/924/2020-SCA.**—In pursuance of the Lahore High Court, Lahore's Letter No.886/HR-II dated 15th December, 2020, Mr. Abid Hussain, Supervisor IT (BS-17) of the Lahore High Court, is appointed in this Court as Director IT (BS-18), on deputation basis, initially for a period of three years, with effect from 17th December, 2020. He is allowed to draw deputation allowance @ 20% of his basic pay subject to maximum of Rs.12,000/- per month and other usual allowances as may be admissible to the employees of this Court, from time to time.

This issues with the approval of the Hon'ble Chief Justice of Pakistan.

A. SHABBIR KHAN KHATTAK,  
Deputy Registrar (Admn).

---

Islamabad, the 28th December, 2020

**No. F.24/596/2001-SCA.**—Malik Sohail Ahmad, Senior Deputy Director (Software) (BPS-19) of this Court is granted sixteen (16) days' leave on full pay with effect from 4th December, 2020 to 19th December, 2020, on medical ground, subject to verification of title of his leave account by the AGPR, Islamabad.

**No. F.24/701/2006-SCA.**—Mr. Arif Mehmood, Private Secretary (BPS-18) of this Court is granted eight (08) days' leave on full pay with effect from 26th December, 2020 to 2nd January, 2021, on account of private affairs, subject to verification of title of his leave account by the AGPR, Islamabad.

**No. F.24/667/2005-SCA.**—Mr. Abdul Sattar, Stenotypist (BPS-16) of this Court is granted one hundred and eight (108) days' leave on full pay with effect from 2nd September, 2020 to 18th December, 2020, on medical grounds, subject to verification of title of his leave account by the AGPR, Islamabad.

Islamabad, the 30th December, 2020

**No. F.24/896/2019-SCA.**—In continuation of this Court's notifications of even number dated 11th January, 2019 and 21st December, 2019, the probationary period of Mr. Muhammad Arshad, Judicial Assistant (BS-16) of this Court is terminated and he is allowed to continue to officiate as such with effect from 27th December, 2020 till further orders.

This issues with the approval of the competent authority.

**No. F.24/895/2019-SCA.**—In continuation of this Court's notifications of even number dated 11th January, 2019 and 13th December, 2019, the probationary period of Mr. Suresh Kumar, Judicial Assistant (BS-16) of this Court is terminated and he is allowed to continue to officiate as such with effect from 21st December, 2020 till further orders.

This issues with the approval of the competent authority.

**No. F.24/897/2019-SCA.**—In continuation of this Court's notifications of even number dated 11th January, 2019 and 21st December, 2019, the probationary period Mr. Muhammad Nawaz, Judicial Assistant (BS-16) of this Court is terminated and he is allowed to continue to officiate as such with effect from 22nd December, 2020 till further orders.

This issues with the approval of the competent authority.

PERVAIZ IQBAL,  
Assistant Registrar (Admn).

---

FEDERAL SHARIAT COURT

Islamabad, the 21st December, 2020

**No. F.9(5)/2002-Admn-FSC.**—In continuation of this Court's notification of even number dated 14th December, 2020, during the period of Winter Holidays, the following arrangements have been made for hearing and disposal of all urgent matters which may require to be dealt with immediately:-

- a. Hon'ble Chief Justice wherever available.
- b. In the absence of Hon. Chief Justice, the next senior most Judge available at any place at Islamabad/ Lahore / Karachi/ Peshawar /Quetta.

- c. In case no Judge is available at the principal seat or at any particular Registry, the petitioner may reach the nearest Registry where any Hon. Judge is available.

GHULAM RASOOL,  
Deputy Registrar (Admn).

Islamabad, the 24th December, 2020

**No. F.1(175)/83-Admn-FSC.**—In pursuance of Cabinet Division's Letter No.6/7/2011-CPC, dated 12th December, 2011 and in exercise of powers conferred under Rule 5 of the Federal Shariat Court (Terms & Conditions of Service of Staff) Rules, 1982, the Hon'ble Chief Justice, Federal Shariat Court has been pleased to allow the benefit of Policy for Monetization of Transport Facility to Mr. Ghulam Rasool Deputy Registrar (BPS-20) of this Court @ Rs.65,960/- per month with effect from 21st November, 2020.

MUHAMMAD ILYAS,  
Assistant Registrar (Admin).

Islamabad, the 29th December, 2020

**No. F.1(341)/92-Admn-FSC.**—Mr. Muhammad Tariq, Assistant Registrar (B-19) of this Court for granted 01 day leave with full pay on 19th December, 2020 subject to verification by the Audit.

On return from leave he has joined the same post at the same station on 21st December, 2020 (20th December, 2020 was holiday being Sunday).

ABDUL HAMEED,  
Superintendent (Admn).



PUBLISHED BY AUTHORITY

KARACHI, WEDNESDAY, FEBRUARY 17, 2021

## PART II

Notifications issued by Ministry of Defence and Ministry of Defence Production

Karachi, the 17th February, 2021

MINISTRY OF DEFENCE

(Defence Division)

**No. 114/2021:**

A/No. 8471802 Mr. Muhammad Siddique, SSO (BS-18/Acting Charge) of Military Engineering Services is promoted to SSO (BS-18) on regular basis, in Military Engineering Services with effect from 8th December, 2020.

The officer will be on probation for a period of one year in accordance with the relevant rules.

[No.F. 1/14/D-3 (A-III)/2016].

**No. 115/2021:**

A/No. 8471800 Mr. Muhammad Asif Nasim, SSO (BS-18/Acting Charge) of Military Engineering Services is promoted to SSO (BS-18) on regular basis, in Military Engineering Services with effect from 8th December, 2020.

The officer will be on probation for a period of one year in accordance with the relevant rules.

[No.F. 1/14/D-3 (A-III)/2016].

**No. 116/2021:**

A/No. 8471799 Mr. Jamshed Alam, SSO (BS-18/Acting Charge) of Military Engineering Services is promoted to SSO (BS-18) on regular basis, in Military Engineering Services with effect from 8th December, 2020.

The officer will be on probation for a period of one year in accordance with the relevant rules.

[No.F. 1/14/D-3 (A-III)/2016].

**No. 117/2021:**

A/No. 8471776 Mr. Muhammad Anwar Khan, a BS-17 Officer of Military Engineering Services is promoted to the post of Executive Engineer (BS-18) in Military Engineering Services with effect from 8th December, 2020.

The officer will be on probation for a period of one year in accordance with the relevant rules.

[No.F. 1/14/D-3 (A-III)/2016].

**No. 118/2021:**

A/No. 8471777 Ms. Madiha Saeed, a BS-17 Officer of Military Engineering Services is promoted to the post of Executive Engineer (BS-18) in Military Engineering Services with effect from 8th December, 2020.

The officer will be on probation for a period of one year in accordance with the relevant rules.

[No.F. 1/14/D-3 (A-III)/2016].

**No. 119/2021:**

A/No. 8471790 Mr. Muhammad Naveed Iqbal, a BS-17 Officer of Military Engineering Services is promoted to the post of Executive Engineer (BS-18) in Military Engineering Services with effect from 8th December, 2020.

The officer will be on probation for a period of one year in accordance with the relevant rules.

[No.F. 1/14/D-3 (A-III)/2016].

**No. 120/2021:**

A/No. 8471778 Mr. Muhammad Kashif Ilyas, a BS-17 Officer of Military Engineering Services is promoted to the post of Executive Engineer (BS-18) in Military Engineering Services with effect from 8th December, 2020.

The officer will be on probation for a period of one year in accordance with the relevant rules.

[No.F. 1/14/D-3 (A-III)/2016].

**No. 121/2021:**

A/No. 8471791 Mr. Mumtaz Ali, a BS-17 Officer of Military Engineering Services is promoted to the post of Executive Engineer (BS-18) in Military Engineering Services with effect from 8th December, 2020.

The officer will be on probation for a period of one year in accordance with the relevant rules.

[No.F. 1/14/D-3 (A-III)/2016].

**No. 122/2021:**

A/No. 8471780 Mr. Muhammad Safdar, a BS-17 Officer of Military Engineering Services is promoted to the post of Executive Engineer (BS-18) in Military Engineering Services with effect from 8th December, 2020.

The officer will be on probation for a period of one year in accordance with the relevant rules.

[No.F. 1/14/D-3 (A-III)/2016].

**No. 123/2021:**

A/No. 8471870 Mr. Usamah Rashid Qureshi, a BS-17 Officer of Military Engineering Services is promoted to the post of Executive Engineer (BS-18) in Military Engineering Services with effect from 8th December, 2020.

The officer will be on probation for a period of one year in accordance with the relevant rules.

[No.F. 1/14/D-3 (A-III)/2016].

**No. 124/2021:**

A/No. 8471781 Mr. Waqar Haider, a BS-17 Officer of Military Engineering Services is promoted to the post of Executive Engineer (BS-18) in Military Engineering Services with effect from 8th December, 2020.

The officer will be on probation for a period of one year in accordance with the relevant rules.

[No.F. 1/14/D-3 (A-III)/2016].

**No. 125/2021:**

A/No. 8471853 Mr. Muhammad Tariq Shah, a BS-16 Officer of Military Engineering Services is promoted to Assistant Executive Engineer BS-17 in Military Engineering Services with effect from 8th December, 2020.

The officer will be on probation for a period of one year in accordance with the relevant rules.

[No.F. 1/14/D-3 (A-III)/2016].

**No. 126/2021:**

A/No. 8471921 Mr. Asghar Ali Shah, a BS-16 Officer of Military Engineering Services is promoted to Assistant Executive Engineer BS-17 in Military Engineering Services with effect from 8th December, 2020.

The officer will be on probation for a period of one year in accordance with the relevant rules.

[No.F. 1/14/D-3 (A-III)/2016].

**No. 127/2021:**

A/No. 8471926 Mr. Zulfiqar Javed, a BS-16 Officer of Military Engineering Services is promoted to Assistant Executive Engineer BS-17 in Military Engineering Services with effect from 8th December, 2020.

The officer will be on probation for a period of one year in accordance with the relevant rules.

[No.F. 1/14/D-3 (A-III)/2016].

**No. 128/2021:**

A/No. 8471963 Mr. Tariq Farid, a BS-16 Officer of Military Engineering Services is promoted to Assistant Executive Engineer BS-17 in Military Engineering Services with effect from 8th December, 2020.

The officer will be on probation for a period of one year in accordance with the relevant rules.

[No.F. 1/14/D-3 (A-III)/2016].

**No. 129/2021:**

A/No. 8471960 Mr. Muhammad Moeed, a BS-16 Officer of Military Engineering Services is promoted to Assistant Executive Engineer BS-17 in Military Engineering Services with effect from 8th December, 2020.

The officer will be on probation for a period of one year in accordance with the relevant rules.

[No.F. 1/14/D-3 (A-III)/2016].

**No. 130/2021:**

A/No. 8472019 Mr. Abdul Ghafoor, a BS-16 Officer of Military Engineering Services is promoted to Assistant Executive Engineer BS-17 in Military Engineering Services with effect from 8th December, 2020.

The officer will be on probation for a period of one year in accordance with the relevant rules.

[No.F. 1/14/D-3 (A-III)/2016].

**No. 131/2021:**

A/No. 8472022 Mr. Shabbir Ahmed, a BS-16 Officer of Military Engineering Services is promoted to Assistant Executive Engineer BS-17 in Military Engineering Services with effect from 8th December, 2020.

The officer will be on probation for a period of one year in accordance with the relevant rules.

[No.F. 1/14/D-3 (A-III)/2016].



**No. 132/2021:**

A/No. 8471898 Mr. Akhtar Mehmood, a BS-16 Officer of Military Engineering Services is promoted to Assistant Executive Engineer BS-17 in Military Engineering Services with effect from 8th December, 2020.

The officer will be on probation for a period of one year in accordance with the relevant rules.

[No.F. 1/14/D-3 (A-III)/2016].

**No. 133/2021:**

A/No. 8471856 Mr. Maqsood Ahmed, a BS-16 Officer of Military Engineering Services is promoted to Assistant Executive Engineer BS-17 in Military Engineering Services with effect from 8th December, 2020.

The officer will be on probation for a period of one year in accordance with the relevant rules.

[No.F. 1/14/D-3 (A-III)/2016].

**No. 134/2021:**

The competent authority i.e. Secretary Defence has accepted the resignation of Mr. Junaid Ali, Assistant Director (BS-17), Survey of Pakistan with immediate effect.

[No.1-8/2012/D-34].

**No. 135/2021:**

Mr. Nasrullah Khan Bhutta, Section Officer (D-36) has been allowed to hold the Additional Charge of the post of Section Officer (D-35) in addition to his own duties for a period of 45 days with effect from 10th December, 2020.

This issues with the approval of competent authority.

[No.2/8/2019/D-26 (Admin-I)].

**No. 136/2021:**

PA-36045 Maj. Rana Zahid Latif (Retd.). ASC has been granted Honorary Rank of Lieutenant Colonel with effect from 31st July, 2020.

[No.F. 5/1/D-2 (A-II)/2020].

**No. 137/2021:**

In pursuance of Establishment Division's Notification No.F.39/1004/2013-E-I dated 14th December, 2020, Mir Hassan Naqvi, a BS-20 officer of Secretariat Group, on his transfer and posting in Aviation Division, has relinquished the charge of the post of Joint Secretary (BS-20), Ministry of Defence on 29th December, 2020.

[No.1/6/2013/D-26 (Admin-I)].

MIAN MUHAMMAD HILAL HUSSAIN *HI (M)*,  
*Lt. Gen. (Retd.) Secretary.*

---

**MINISTRY OF DEFENCE PRODUCTION****No. 138/2021:**

In pursuance of Establishment Division's Notification No.1-50/2012-E-2 dated 3rd February, 2020, Mr. Muhammad Naeem Akhtar has relinquished the charge of the post of Deputy Secretary (BPS-19), in Ministry of Defence Production, Rawalpindi on 13th December, 2020.

[No.2/2/2018/DP-2].

**No. 139/2021:**

In pursuance of Establishment Division's Notification No.F.1-40/2011-E-2 dated 17th December, 2020, Raja Tanveer Azmi has relinquished the charge of the post of Deputy Secretary, Ministry of Defence Production, Rawalpindi on 24th December, 2020.

[No.2/3/2020/DP-2].

MUHAMMAD AWAIS QARNI,  
Section Officer.

[AIRCRAFT REBUILD FACTORY PAKISTAN AERONAUTICAL COMPLEX BOARD]

**No. 140/2021:**

The Competent Authority (Managing Director ARF) is pleased to designate the Authority and Authorized Officer for category of Government Servants as mentioned below:-

<b>Category of Govt. Servants</b>	<b>Authority</b>	<b>Authorized Officer</b>
Government Servants holding posts in BPS-01 to 15 or equivalent	Managing Director	Director HRM

2. The Authority and Authorized Officer will commence functioning after publication of the same in the Gazette of Pakistan.

[No.ARF/3141/1/PC].

TAHIR MAHMOOD, *Group Captain (R)*,  
Director HRM.



REGISTERED No. M-302



# The Gazette of Pakistan

PUBLISHED BY AUTHORITY

KARACHI, WEDNESDAY, FEBRUARY 17, 2021

## PART III

Notifications issued by the High Courts, the Federal Public Service Commission and by the Attached and Subordinate Offices of the Government of Pakistan

AHK NATIONAL CENTRE FOR RURAL DEVELOPMENT

Islamabad, the 7th December, 2020

Islamabad, the 9th December, 2020

**No. F.5(88)/83-Admin.**—Mr. Abdul Rauf, Assistant Private Secretary (BPS-16) Akhtar Hameed Khan National Centre for Rural Development (AHKNCRD), Islamabad was granted 19 days leave on full pay (LFP) with effect from 16th November, 2020 to 4th December, 2020 with permission to prefix & suffix weekly holidays from 14th - 15th November, 2020 and 5th - 6th December, 2020.

After the expiry of above leave, the officer has assumed the charge of the post of Assistant Private Secretary on the same post in AHKNCRD on 7th December, 2020.

MUHAMMAD YOUSAF,  
Administrative Officer.

**No. BE(Admn-Estt)1(159)/2017-6616.**—Consequent upon the recommendation of DPC-II held on 4th December, 2020, the competent authority, Director General (BEOE) has been pleased to promote Mr. Safdar Hussain Bhatti, Assistant (BS-16) to the post of Admin Officer (BS-16) with immediate effect.

The officer will be on probation for a period of one year from the date of actualization of his promotion. The period of probation may be curtailed for good and sufficient reasons, to be recorded, or, if considered necessary, it may be extended for another period not exceeding one year by specific order. If no order is issued, on the expiry of the first year of probation period, the period of probation shall be deemed to have been extended automatically. Provided further that in the absence of an order, the period of probation shall on the expiry of extended period, be deemed to have been successfully completed.

This issues with the approval of Director General, BE&OE.

MUHAMMAD ISRAR,  
Assistant Director (Estt).

BUREAU OF EMIGRATION AND OVERSEAS  
EMPLOYMENT

Islamabad, the 15th December, 2020

**No. BE(Admn-Estt)2(220)/84-6756.**—In pursuance of Bureau of Emigration and Overseas Employment Notification No. BE(Admn-Estt)2(159)/2017/6616 dated 7th December, 2020. Mr. Safdar Hussain Bhatti, has assumed the charge of the post of Admin Officer (BS-16), Bureau of Emigration and Overseas Employment on 15th December, 2020.

This issues with the approval of Director General, BE&OE.

ABDUL SHAKOOR SOOMRO,  
Deputy Director (Estt).

CENTRAL DIRECTORATE OF NATIONAL SAVINGS

Islamabad, the 25th November, 2020

**No. F.1(523)Admn-I/2013.**—Mr. Talib Hussain, National Savings Officer, (Current Charge) (BS-17) Regional Directorate of National Savings, Faisalabad, stand retire from Government Service with effect from 9th December, 2020, on attaining the age of superannuation (being date of birth as 10th December, 1960).





In terms of Section 18-A (I) of the Revised Leave Rules 1980, read with Finance Division's SRO No. 70(KE)/2012 dated 29th August, 2012 and O.M. dated 28th January, 2013, the competent authority has approved request for 365 days leave encashment in lieu of LPR in respect of above named officer, leave pay for the purpose of encashment of LPR shall be computed on the basis of pay and allowances reckonable towards pension as shown in his last pay certificate.

**No. F.1(610)Admn-I/2013.**—Mr. Azeem Munawar, National Savings Officer (Current Charge) (BS-17) Regional Directorate of National Savings, Karachi stand retired from Government Service with effect from 11th December, 2020, on attaining the age of superannuation (being date of birth as 12th December, 1960).

In terms of Section 18-A (I) of the Revised Leave Rules 1980, read with Finance Division's SRO No. 70(KE)/2012 dated 29th August, 2012 and O.M. dated 28th January, 2013, the competent authority has approved request for 365 days leave encashment in lieu of LPR in respect of above named officer, leave pay for the purpose of encashment of LPR shall be computed on the basis of pay and allowances reckonable towards pension as shown in his last pay certificate.

MADIHA TAHIR,  
National Savings Officer (HR).

Mr. Nauman Bashir has assumed the charge of the post of Lecturer (Pak-Studies) (PPS-07) in the Development Project "Up-gradation of National Special Education Centre for Hearing Impaired Children, Islamabad from Higher Secondary to Graduation Level" with effect from 19th October, 2020.

**No. F.1-25/2019-A-I(Pt).**—Mr. Abid Naveed, is appointed as Senior Teacher (PPS-07) with effect from 27th October, 2020 in the Development Project "Establishment of Resource Unit for Autistic Children at National Special Education Centre for Mentally Retarded Children, Islamabad" on contract basis up to 30th June, 2021 on usual terms and conditions as mentioned in his offer of appointment *vide* No. F.1-25/2018/A-I dated 13th October, 2020.

Mr. Abid Naveed, has assumed the charge of the post of Senior Teacher (PPS-07) in the Development Project "Establishment of Resource Unit for Autistic Children at National Special Education Centre for Mentally Retarded Children, Islamabad" with effect from 27th October, 2020.

**No. F.1-25/2019-A-I(Pt).**—Ms. Sadia Sabir is appointed as Clinical Psychologist (PPS-07) with effect from 19th October, 2020 in the Development Project "Establishment of Resource Unit for Autistic Children at National Special Education Centre for Mentally Retarded Children, Islamabad" on contract basis up to 30th June, 2021 on usual terms and conditions as mentioned in his offer of appointment *vide* No. F.1-25/2018/A-I dated 13th October, 2020.

Ms. Sadia Sabir has assumed the charge of the post of Clinical Psychologist (PPS-07) in the Development Project "Establishment of Resource Unit for Autistic Children at National Special Education Centre for Mentally Retarded Children, Islamabad" with effect from 19th October, 2020.

**No. F.1-25/2019-A-I(Pt).**—Hafiz Anees-ur-Rehman, is appointed as Lecturer (Special Education) (PPS-07) with effect from 15th October, 2020 in the Development Project "Up-gradation of National Special Education Centre for Hearing Impaired Children, Islamabad from Higher Secondary to Graduation Level" on contract basis up to 30th June, 2021 on usual terms and conditions as mentioned in his offer of appointment *vide* No. F.1-25/2018/A-I dated 13th October, 2020.

Hafiz Anees-ur-Rehman has assumed the charge of the post of Lecturer (Special Education) (PPS-07) in the Development Project "Up-gradation of National Special Education Centre for Hearing Impaired Children, Islamabad from Higher Secondary to Graduation Level" with effect from 15th October, 2020.

DIRECTORATE GENERAL OF SPECIAL EDUCATION

Islamabad, the 18th November, 2020

**No. F.1-25/2019-A-I(Pt).**—Ms. Malika Mahrukh is appointed as Speech Therapist (PPS-07) with effect from 26th October, 2020 in the Development Project "Establishment of Resource Unit for Autistic Children at National Special Education Centre for Mentally Retarded Children, Islamabad" on contract basis up to 30th June, 2021 on usual terms and conditions as mentioned in her offer of appointment *vide* No. F.1-25/2018/A-I dated 13th October, 2020.

Ms. Malika Mahrukh has assumed the charge of the post of Speech Therapist (PPS-07) in the Development Project "Establishment of Resource Unit for Autistic Children at National Special Education Centre for Mentally Retarded Children, Islamabad" with effect from 26th October, 2020.

**No. F.1-25/2019-A-I(Pt).**—Mr. Nauman Bashir, is appointed as Lecturer (Pak. Studies) (PPS-07) with effect from 19th October, 2020 in the Development Project "Up-gradation of National Special Education Centre for Hearing Impaired Children, Islamabad from Higher Secondary to Graduation Level" on contract basis up to 30th June, 2021 on usual terms and conditions as mentioned in his offer of appointment issued *vide* No. F.1-25/2018/A-I dated 13th October, 2020.

**No. F.1-25/2019-A-I(Pt).**—Ms. Sumaira Tabassum, is appointed as Assistant Professor (English) (PPS-08) with effect from 15th October, 2020 in the Development Project "Up-gradation of National Special Education Centre for Hearing Impaired Children, Islamabad from Higher





Secondary to Graduation Level" on contract basis up to 30th June, 2021 on usual terms and conditions as mentioned in her offer of appointment *vide* No. F.1-25/2018/A-I dated 13th October, 2020.

Ms. Sumaira Tabassum has assumed the charge of the post of Assistant Professor (English) (PPS-08) in the Development Project "Up-gradation of National Special Education Centre for Hearing Impaired Children, Islamabad from Higher Secondary to Graduation Level" with effect from 15th October, 2020.

**No. F.1-25/2019-A-I(Pt).**—Mr. Muhammad Aman Abbasi is appointed as Occupational Therapist (PPS-07) with effect from 23rd October, 2020 in the Development Project "Establishment of Resource Unit for Autistic Children at National Special Education Centre for Mentally Retarded Children, Islamabad" on contract basis up to 30th June, 2021 on usual terms and conditions as mentioned in his offer of appointment *vide* No. F.1-25/2018/A-I dated 13th October, 2020.

Mr. Muhammad Aman Abbasi has assumed the charge of the post of Occupational Therapist (PPS-07) in the Development Project "Establishment of Resource Unit for Autistic Children at National Special Education Centre for Mentally Retarded Children, Islamabad" with effect from 23rd October, 2020.

**No. F.1-25/2019-A-I(Pt).**—Ms. Hufsa Shahzad is appointed as Prosthetist/Orthotist (PPS-07) with effect from 15th October, 2020 in the Development Project "Establishment of Orthopedic Workshop at National Special Education Centre for Physically Handicapped Children G-8/4, Islamabad" on contract basis up to 30th June, 2021 on usual terms and conditions as mentioned in her offer of appointment issued *vide* No. F.1-25/2018/A-I dated 13th October, 2020.

Ms. Hufsa Shahzad has assumed the charge of the post of Prosthetist/Orthotist (PPS-07) in the Development Project "Establishment of Orthopedic Workshop at National Special Education Centre for Physically Handicapped Children G-8/4, Islamabad" with effect from 15th October, 2020.

**No. F.1-25/2019-A-I(Pt).**—Ms. Aqsa Ali Khan, is appointed as Prosthetist/Orthotist (PPS-07) with effect from 15th October, 2020 in the Development Project "Establishment of Orthopedic Workshop at National Special Education Centre for Physically Handicapped Children G-8/4, Islamabad" on contract basis up to 30th June, 2021 on usual terms and conditions as mentioned in her offer of appointment *vide* No. F.1-25/2018/A-I dated 13th October, 2020.

Ms. Aqsa Ali Khan has assumed the charge of the post of Prosthetist/Orthotist (PPS-07) in the Development Project "Establishment of Orthopedic Workshop at National Special Education Centre for Physically Handicapped Children G-8/4, Islamabad" with effect from 15th October, 2020.

**No. F.1-25/2019-A-I(Pt).**—Ms. Nabiha Muzaffar is appointed as Lecturer (Fine Arts) (PPS-07) with effect from 21st October, 2020 in the Development Project "Up-gradation of National Special Education Centre for Hearing Impaired Children, Islamabad from Higher Secondary to Graduation Level" on contract basis up to 30th June, 2021 on usual terms and conditions as mentioned in her offer of appointment issued *vide* No. F.1-25/2018/A-I dated 13th October, 2020.

Ms. Nabiha Muzaffar has assumed the charge of the post of Lecturer (Fine Arts) (PPS-07) in the Development Project "Up-gradation of National Special Education Centre for Hearing Impaired Children, Islamabad from Higher Secondary to Graduation Level" with effect from 21st October, 2020.

**No. F.1-25/2019-A-I(Pt).**—Ms. Samra Jabbar is appointed as Senior Teacher (PPS-07) with effect from 23rd October, 2020 in the Development Project "Establishment of Resource Unit for Autistic Children at National Special Education Centre for Mentally Retarded Children, Islamabad" on contract basis up to 30th June, 2021 on usual terms and conditions as mentioned in her offer of appointment issued *vide* No. F.1-25/2018/A-I dated 13th October, 2020.

Ms. Samra Jabbar has assumed the charge of the post of Senior Teacher (PPS-07) in the Development Project "Establishment of Resource Unit for Autistic Children at National Special Education Centre for Mentally Retarded Children, Islamabad" with effect from 23rd October, 2020.

**No. F.1-25/2019-A-I(Pt).**—Ms. Amna is appointed as Lecturer (Health & Physical Education) (PPS-07) with effect from 16th October, 2020 in the Development Project "Up-gradation of National Special Education Centre for Hearing Impaired Children, Islamabad from Higher Secondary to Graduation Level" on contract basis up to 30th June, 2021 on usual terms and conditions as mentioned in her offer of appointment *vide* No. F.1-25/2018/A-I dated 13th October, 2020.

Ms. Amna has assumed the charge of the post of Lecturer (Health & Physical Education) (PPS-07) in the Development Project "Up-gradation of National Special Education Centre for Hearing Impaired Children, Islamabad from Higher Secondary to Graduation Level" with effect from 16th October, 2020.

**No. F.1-25/2019-A-I(Pt).**—Mr. Abdullah Waseem is appointed as Lecturer (Islamiyat) (PPS-07) with effect from 15th October, 2020 in the Development Project "Up-gradation of National Special Education Centre for Hearing Impaired Children, Islamabad from Higher Secondary to Graduation Level" on contract basis up to 30th June, 2021 on usual terms and conditions as mentioned in his offer of appointment *vide* No. F.1-25/2018/A-I dated 13th October, 2020.

Mr. Abdullah Waseem has assumed the charge of the post of Lecturer (Islamiyat) (PPS-07) in the Development





Project "Up-gradation of National Special Education Centre for Hearing Impaired Children, Islamabad from Higher Secondary to Graduation Level" with effect from 15th October, 2020.

**No. F.1-25/2019-A-I(Pt).**—Syeda Zahra Tousif is appointed as Speech Therapist (PPS-07) with effect from 21st October, 2020 in the Development Project "Establishment of Resource Unit for Autistic Children at National Special Education Centre for Mentally Retarded Children, Islamabad" on contract basis up to 30th June, 2021 on usual terms and conditions as mentioned in her offer of appointment *vide* No. F.1-25/2018/A-I dated 13th October, 2020.

Syeda Zahra Tousif has assumed the charge of the post of Speech Therapist (PPS-07) in the Development Project "Establishment of Resource Unit for Autistic Children at National Special Education Centre for Mentally Retarded Children, Islamabad" with effect from 21st October, 2020.

**No. F.1-25/2019-A-I(Pt).**—Mr. Mujahid-ul-Islam is appointed as Physical Training Instructor (PPS-06) with effect from 16th October, 2020 in the Development Project "Up-gradation of National Special Education Centre for Hearing Impaired Children, Islamabad from Higher Secondary to Graduation Level" on contract basis up to 30th June, 2021 on usual terms and conditions as mentioned in his offer of appointment *vide* No. F.1-25/2018/A-I dated 13th October, 2020.

Mr. Mujahid-ul-Islam has assumed the charge of the post of Physical Training Instructor (PPS-06) in the Development Project "Up-gradation of National Special Education Centre for Hearing Impaired Children, Islamabad from Higher Secondary to Graduation Level" with effect from 16th October, 2020.

DR. AHMED NADEEM,  
Deputy Director (Admin).

FEDERAL DIRECTORATE OF EDUCATION

[ISLAMABAD MODEL COLLEGE FOR BOYS]

Islamabad, the 24th November, 2020

**No. IMCB/PF/20/2020/970.**—Mrs. Riffat Luqman, Junior Lady Teacher (BS-16), Islamabad Model College for Boys, F-8/4 Islamabad is hereby granted Iddat Leave for 130 days with effect from 7th November, 2020 to 17th March, 2021 on full pay.

On the expiry of leave, the above named Government Servant is expected to resume her duty on the same station *i.e.* IMCB F-8/4, Islamabad.

PROF. DR. MUHAMMAD YASEEN AFAFI,  
Principal.

FEDERAL GOVERNMENT POLYCLINIC

[POSTGRADUATE MEDICAL INSTITUTE]

Islamabad, the 26th November, 2020

**No. FGPC.1/4884/2010.**—Mr. Shahid Hussain, Charge Nurse (BS-16) of Federal Government Polyclinic, Islamabad has resumed duty on 7th November, 2020 after completion of MSc Nursing Programme at Ziauddin University, Karachi, posted in College of Nursing G-7/3-4, Islamabad for duty.

DR. FAROOQ AKHTAR,  
Deputy Executive Director.

GENERAL HEADQUARTERS FGEI (C/G) DIRECTORATE

(IGT & E Branch)

Rawalpindi, the 24th November, 2020

**No. 04/PF-1119/88-FGEI(CA).**—Consequent upon her request of retirement on completion of 25 years of qualifying Service *i.e.* 32 years, Mrs. Tahira Qabool, Assistant Professor (BPS-19 in Time Scale), FG Inter College, Abbottabad Cantt. is hereby granted Encashment of LPR for 365 days from 2nd December, 2019 to 30th November, 2020 in accordance with Finance Division's O.M. No. F.1(ii)-IMP/83 dated 18th August, 1983 & SRO. (I)/2012 dated 29th August, 2012.

Certified that 368 days leave on full pay stands at her credit as verified by the Audit Office.

On expiry of encashment period, she will stand retired from Government Service and her name will be struck off the strength of the said institution with effect from 30th November, 2020 (AN).

Rawalpindi, the 25th November, 2020

**No. 04/PF-1555/02-FGEI(CA).**—Mrs. Shama Parveen, Assistant Professor of Chemistry (BPS-18) FG Girls Inter College, Karachi Cantt. is granted extension in medical leave for 36 days on full pay with effect from 22nd September, 2020 to 27th October, 2020.

On expiry of above leave, she is expected to resume duty at Karachi.

**No. 04/PF-4/6-Gen-FGEI(CA).**—Mrs. Nabila Shaheen, Lecturer (BPS-17), FG Postgraduate College for Women, Kashmir Road, Rawalpindi Cantt. is granted maternity leave (pre/post-confinement) for 77 days with effect from 13th August, 2020 to 28th October, 2020.

This is issued in supersession of this Directorate's letter of even number dated 9th October, 2020.

MUHAMMAD GHAFFAR, *Lt. Col.*  
For Director General.





Rawalpindi, the 24th November, 2020

**No. 04/PF-111/77-FGEI(M).**—This Directorate notification of even number dated 28th August, 2020 in respect of Mr. Hidayat Ali Shah, Principal (BPS-18) FG Junior Public School No. 3 (Boys) (2nd Shift) Chaklala Rawalpindi is hereby cancelled.

**No. 04/PF-217/77-FGEI(M).**—Mr. Ghulam Sajjad, SST, FG Public School (Boys) Daryabad, Rawalpindi Cantt. is hereby granted leave on full pay for 14 days from 9th September, 2020 to 22nd September, 2020 on private affairs.

Rawalpindi, the 26th November, 2020

**No. 04/PF-687/77-FGEI(SA).**—Mrs. Zarina Bibi, TGT, FG Public School No. 7 (Girls) Wah Cantt. is hereby granted 3 days ex-Pakistan leave on full pay with effect from 25th December, 2020 to 27th December, 2020 (during winter vacations) and this Directorate has no objection for proceeding her abroad (UAE) for private visit during this period, subject to the condition that no foreign exchange will be involved on the part of Government of Pakistan on any account.

No further extension will be granted after expiry of ex-Pakistan leave.

**No. 04/PF-384/77-FGEI(SA).**—Mrs. Shahida Jamil, SS, FG Higher Secondary School (Girls) COD Kala Jhelum

Cantt. is hereby granted 20 days leave on full pay with effect from 5th October, 2020 to 24th October, 2020 on medical grounds.

ALI RAZA SHAH, *Maj.*  
For Director General.

HEADQUARTERS, AIRPORTS SECURITY FORCE

Karachi, the 24th November, 2020

**No. 51/885/2000/FS-I.**—Consequent upon his transfer SF-706 Director Malik Ishrat Javed handed over charge of the post of Director at ASF Islamabad att. Peshawar Airport on 24th October, 2020 and taken over charge of the same post at HQ ASF Karachi on 26th October, 2020.

**No. 51/1135/2008/FS-I.**—On attaining the age of superannuation *i.e.* 60 years SF-918 Deputy Director Syed Athar Hussain Zaidi has been retired from Government Service with effect from 8th November, 2020. The officer relinquished charge of the post of Deputy Director at ASF Academy Karachi on 7th November, 2020 (A/N).

**No. 51/1113/2007/FS-I.**—Consequent upon his transfer, SF-897 Deputy Director Muhammad Aslam Shad handed over charge of the post of Deputy Director at HQ ASF Karachi on 11th September, 2020 and taken over charge of the same post at ASF Rawalakot att. Lahore Airport on 13th October, 2020.

**No. 43/10/2020/FS-I.**—Following Deputy Directors (BPS-18) of ASF were granted leave on full pay subject to entitlement for the period as mentioned against their names:-

S. No.	F. No.	Name	Station	Days	From	To	Date of Resumption
1.	SF-708	Noushad Ahmed	Peshawar Airport	25	20.03.2020	13.04.2020	14.04.2020
				10	19.09.2020	28.09.2020	29.09.2020
2.	SF-764	Zaheer Hussain	Lahore Airport	21	31.01.2020	20.02.2020	21.02.2020
				21	20.05.2020	09.06.2020	10.06.2020
3.	SF-759	S. Muhammad Taqi	Mianwali att. D. G Khan Airport	20	17.08.2020	05.09.2020	06.09.2020
4.	SF-790	Nawab Din Dogar	Karachi Airport	10	26.06.2020	04.09.2020	05.09.2020
5.	SF-913	Abdul Rehman	Multan Airport	16	06.10.2020	21.10.2020	22.10.2020

2. Above named officers took over charge of the same post at the same Airports/Stations on the dates as shown against each.





Karachi, the 25th November, 2020

**No. 51/1169/2009/FS-I.**—Consequent upon his transfer SF-945 Additional Director Pervaiz Akhtar handed over charge of the post of Additional Director at HQ ASF Karachi on 6th November, 2020 and taken over charge of the same post at ASF Peshawar Airport on 13th November, 2020.

**No. 51/1437/2017/FS-I.**—Consequent upon his transfer, PA-36073 Additional Director Lt. Col. Riaz Ahmed handed over charge of the post of Additional Director at HQ ASF Karachi on 7th November, 2020 and taken over charge of the same post at AF Multan Airport on 9th November, 2020.

SHAFIQ-UR-REHMAN,  
Additional Director/Force Secretary.

MARINE FISHERIES DEPARTMENT

Karachi, the 26th November, 2020

**No. F.1-4/2016-Estt/5557.**—In pursuance of Ministry of Maritime Affairs, Islamabad's Letter No. 1(41)/2017-Fish-B dated 25th November, 2020, Mrs. Shazia Naz, Director (Quality Control), BS-19 of this department has been granted twenty eight (28) days *ex-Pakistan* leave on full pay with effect from 27th November, 2020 to 24th December, 2020 along with suffixing closed holidays falling on 25th, 26th & 27th December, 2020, to visit her family and perform Umrah.

On the expiry of above leave, she is likely to resume her duty on the same post and station to which the allowances are attached.

ABDUL JABBAR MIRANI,  
Deputy Director (Q.C).

NATIONAL COUNCIL OF SOCIAL WELFARE

Islamabad, the 20th November, 2020

**No. 1-17/86-NCSW(Admn).**—Mr. Muhammad Afaq, Superintendent (BS-16), in the National Council of Social Welfare, is allowed 40 days leave on full pay with effect from 23rd November, 2020 to 1st January, 2021 by the Chairman, National Council of Social Welfare, under the prescribed Revised Leave Rules, 1980, subject to the title of leave by the office of of the AGPR, Islamabad,

After expiry of the said leave, the officer has resumed his duties on 2nd January, 2021, the same post and station.

S. M. NOMAN WAKIL,  
Superintendent (Admin).

NATIONAL DATABASE & REGISTRATION AUTHORITY

(Registration Directorate)

Islamabad, the 24th November, 2020

**No. NADRA/Regn.4/370-Estt/2955.**—On attaining the age of superannuation, ERP # 1955 Mr. Ejaz Hussain Shah, Assistant Director (BPS-17) DRO NADRA Jhang stands retired from service with effect from 5th October, 2021.

On exercise of option for leave encashment in lieu of LPR, the competent authority is pleased to grant *lump-sum* leave salary equal to 365 days to the officer concerned in terms of Rule 18-A of Revised Leave Rules, 1980, read in conjunction with Finance Division Notification No. SRO.70 (KE)/2012 dated 29th August, 2012.

BILAL SAEED ULLAH KHAN, *Brigadier (Retd.)*,  
Director General.

NATIONAL INSTITUTE OF REHABILITATION MEDICINE

Islamabad, the 13th November, 2020

**No. F.2-159/96-NIRM.**—Mrs. Saima Akhtar, Staff Nurse (BS-16) of this Institute is hereby granted 30 days leave with full pay from 9th November, 2020 to 8th December, 2020.

After expiry of leave she is expected to join her duties on the same post and station.

Islamabad, the 28th November, 2020

**No. F.3-132/2020-NIRM.**—Dr. Sumera, Radiologist (BS-18) of this Institute is hereby granted 16 days leave on medical grounds with effect from 23rd November, 2020 to 8th December, 2020.

After expiry of leave she is expected to join her duties on the same post and station.

DR. ADNAN RIAZ,  
Deputy Director (A).

NATIONAL TRAINING BUREAU

Islamabad, the 26th November, 2020

**No. NTB.2012(8)-Estt.**—Mr. Zaheer Ahmad, Assistant Director (Tech) BPS-17 is hereby granted current charge of the vacant post of Deputy Director (Tech) BPS-18 in National Training Bureau for a period of 3 months (90 days) with immediate effect.

He will be entitled to draw 20% Special Pay of his basic pay subject to maximum of Rs, 12,000/- per month as admissible under the Rules.







This issues with the approval of the Director General, NTB.

**No. NTB.2012(8)-Estt.**—Mir Muhammad Salman, Assistant Director (Tech) BPS-17 is hereby granted current charge of the vacant post of Deputy Director (Tech) BPS-18 in National Training Bureau for a period of 3 months (90 days) with immediate effect.

He will be entitled to draw 20% Special Pay of his basic pay subject to maximum of Rs, 12,000/- per month as admissible under the Rules.

This issues with the approval of the Director General, NTB.

MUHAMMAD ASHRAF ASIM,  
Director (Training).

OFFICE OF THE INSPECTOR GENERAL FRONTIER  
CORPS BALOCHISTAN

Quetta, the 16th November, 2020

**No. 101-9/Cfm/112/E-2(Confirmation).**—On completion of one year probationary period, following Junior Commissioned Officers of Frontier Corps Balochistan (North) are hereby confirmed in their present rank with immediate effect from the dates noted against each:-

1. No. 8791 Subedar Major (General Duty) Sana Ullah, Punjabi of Headquarters Frontier Corps (Headquarter Wing) with effect from 20th September, 2020.
2. No. 4983 Subedar Major (Medical) Muhammad Zahid, Pathan of Frontier Corps Hospital with effect from 23rd August, 2020.
3. No. 16985 Subedar Major (General Duty) Gulma Khan, Pathan of Chiltan Rifles with effect from 13th October, 2020.
4. No. 5221 Subedar (General Duty) Asmat Ullah, Baloch of Ghazaband Scouts with effect from 1st January, 2020.
5. No. 4846 Subedar (General Duty) Abdul Hamid, Pathan of Ghazaband Scouts with effect from 12th July, 2020.
6. No. 17583 Subedar (General Duty) Zahoor Ahmed, Baloch of Chiltan Rifles with effect from 4th May, 2020
7. No. 12188 Subedar (General Duty) Muhammad Suliman, Punjabi of Bambore Rifles with effect from 8th April, 2019.

8. No. 7471 Naib Subedar (Mechanical Transport) Mehr Khan Punjabi of Bambore Rifles with effect from 2nd December, 2019.
9. No. 14279 Naib Subedar (General Duty) Rehmat Ullah, Baloch of Bambore Rifles with effect from 1st January, 2020.
10. No. 9810 Naib Subedar (General Duty) Muhammad Asghar, Baloch of Maiwand Rifles with effect from 16th July, 2020.
11. No. 38102 Naib Subedar (General Duty) Miran Hussain, Baloch of Maiwand Rifles with effect from 1st January, 2020.
12. No. 18023 Naib Subedar (General Duty) Muhammad Ramzan, Baloch of Chiltan Rifles with effect from 29th August, 2020.
13. No. 32809 Naib Subedar (General Duty) Muhammad Riaz, Punjabi of Zhob Militia with effect from 1st April, 2020.
14. No. 29563 Naib Subedar (General Duty) Amir Nawaz, Pathan of Zhob Militia with effect from 25th November, 2018.
15. No. 6245 Naib Subedar (General Duty) Mazhar Mehmood, Punjabi of Zhob Militia with effect from 1st August, 2020.

IMRAN TABISH, *Lieutenant Colonel.*  
*For Inspector General.*

Turbat, the 16th November, 2020

**No. 132-37/Cfm/68/E-2(Confirmation).**—On completion of one year probationary period, No. 6629 Naib Subedar (General Duty) Syed Asif Hussain, Pathan of 140 Wing Awaran Militia is hereby not confirmed in present rank due to earning of 2 negative Annual Confidential Report-2019 & 2020.

MUHAMMAD SHOAB, *Lieutenant Colonel.*  
*For Inspector General.*

OFFICE OF THE INSPECTOR GENERAL FRONTIER  
CORPS KHYBER PAKHTUNKHWA

Peshawar, the 18th November, 2020

**No. 34/Prom/33/X/RW/.**—The following promotions are ordered:-

**TO BE SUBEDAR ON PROBATION OF SIX MONTHS**

1. No. 302838 Naib Subedar Gul Nader Khan of Frontier Corps Intelligent Unit with effect from





- 17th September, 2020 *vice* No. 202751 Subedar Muhammad Abid Khan transferred to Headquarters Frontier Corps Administrative Company Headquarters Wing Hayatabad with effect from 17th September, 2020.
2. No. 802054 Naib Subedar Hassan Zeb 171 Wing Bajaur Scouts (Settle District) with effect from 7th October, 2020 after completion of 3 months deferment period *vice* No. 801912 Subedar Hafizur-Rehman transferred to new raised 177 Wing Bajaur Scouts with effect from 1st December, 2019.
  3. No. 1103027 Naib Subedar Dost Muhammad of 206 Wing Mohmand Rifles (Settle District) with effect from 10th May, 2020 *vice* No. 1200558 Subedar Akhun Zada promoted Subedar Major with effect from 10th May, 2020.
  4. No. 505221 Naib Subedar Abid Shehzad of 233 Wing Orakzai Scouts (Settle District) with effect from 1st August, 2020 *vice* No. 1102478 Subedar Nadir Khan transferred to Headquarters Wing Orakzai Scouts on Extra Regiment Employment with effect from 20th March, 2020.
  5. No. 504788 Naib Subedar Menhaj Din of 234 Wing Orakzai Scouts (Settle District) with effect from 1st August, 2020 *vice* No. 103747 Subedar Muhammad Ishaq Khan proceeded on pension with effect from 31st July, 2020.
  6. No. 1201228 Naib Subedar Izat Khan of 213 Wing Tirah Rifles (Settle District) with effect from 1st October, 2020 from the date of confirmation *vice* No. 302385 Sub. Wakil Khan proceeded pension with effect from 20th August, 2020.
  7. No. 504221 Naib Subedar Zahir Ullah of 106 Wing Khyber Rifles (Tribal District) with effect from 1st August, 2020 *vice* No. 1200075 Subedar Johar Khan proceeded on pension with effect from 31st July, 2020.
  8. No. 702417 Naib Subedar Nooruz Khan of 166 Wing Bara Rifles (Tribal District) with effect from 1st June, 2019 *vice* in existing rotation vacancy between Settle & Tribal District of 166 Wing Bara Rifles.
  9. No. 902042 Naib Subedar Muhammad Firdaus of 181 Wing Dir Scouts (Settle District) with effect from 4th August, 2020 *vice* No. 901893 Subedar Qadar Gul proceeded on pension with effect from 3rd August, 2020.
  10. No. 404555 Naib Subedar Fazal Haq of 143 Wing Chitral Scouts (Settle District) with effect from 1st January, 2019 *vice* No. 404308 Subedar Rehmat Wali transferred to Headquarters Wing Chitral Scouts on Extra Regiment Employment with effect from 1st January, 2019.
  11. No. 1201150 Naib Subedar Zamin Shah of 213 Wing Tirah Rifles (Settle District) with effect from 1st October, 2020 from the date of confirmation *vice* No. 1200860 Subedar Muhammad Arshad proceeded on pension with effect from 13th May, 2020.
  12. No. 1103160 Naib Subedar Sher Zada of 103 Wing Khyber Rifles (Settle District) with effect from 11th January, 2020 *vice* No. 502894 Subedar Rasam Ali promoted Subedar Major with effect from 11th January, 2020.
- TO BE NAIB SUBEDAR ON PROBATION OF SIX MONTHS*
13. No. 203686 Havildar Yasin Ali of 234 Wing Orakzai Scouts (Tribal District) with effect from 22nd January, 2020 from the date of qualification on creation of vacancy in Battalion System in 234 Wing Orakzai Scouts (Tribal District) with effect from 1st July, 2019.
  14. No. 505545 Havildar Zahir Ullah of 234 Wing Orakzai Scouts (Tribal District) with effect from 1st February, 2020 *vice* No. 203651 Subedar Said Ullah promoted Subedar with effect from 1st February, 2020.
  15. No. 105159 Havildar Muhammad Ilyas of Frontier Corps Intelligent Unit with effect from 17th September, 2020 *vice* No. 302838 Naib Subedar Gul Nader Khan promoted Subedar with effect from 17th September, 2020.
  16. No. 1103535 Havildar Aziz Ullah of 203 Wing Mohmand Rifles (Tribal District) with effect from 13th April, 2020 from the date of qualification *vice* No. 1103314 Naib Subedar Sajawat Shah transferred to 207 Wing Mohmand Rifles with effect from 24th November, 2019.
  17. No. 703187 Havildar Baz Muhammad of 166 Wing Bara Rifles (Settle District) with effect from 20th January, 2020 from the date of qualification *vice* in existing vacancy of 166 Wing Bara Rifles with effect from 1st June, 2019.
  18. No. 303764 Havildar Liaqat Ali Khan of Tirah Rifles (Signal Establishment) with effect from 21st April, 2020 *vice* No. 1200285 Naib Subedar Amin Ullah proceeded on pension with effect from 20th April, 2020.
  19. No. 404986 Havildar Mehraban Ali of 141 Wing Chitral Scouts (Tribal District) with effect from 2nd





June, 2020 *vice* No. 404506 Naib Subedar Afzal Ali Shah being promoted Subedar with effect from 2nd June, 2020.

20. No. 404936 Havildar Mehboob Elahi of 141 Wing Chitral Scouts (Tribal District) with effect from 1st April, 2020 *vice* No. 404452 Naib Subedar Rab Nawaz Khan proceeded on pension with effect from 31st March, 2020.
21. No. 405058 Havildar Akram Qabool of 141 Wing Chitral Scouts (Tribal District) with effect from 1st March, 2020 from the date of qualification *vice* No. 404404 Naib Subedar Sultan Salah-ud-Din promoted Subedar with effect from 4th March, 2020.
22. No. 405198 Havildar Noor Ilahi of 143 Wing Chitral Scouts (Settle District) with effect from 21st March, 2020 from the date of qualification *vice* No. 404391 Naib Subedar Shahid Abbas promoted Subedar with effect from 1st January, 2019.
23. No. 405274 Havildar Sarwar-ud-Din of 143 Wing Chitral Scouts (Settle District) with effect from 21st March, 2020 from the date of qualification *vice* No. 404555 Naib Subedar Fazal Haq promoted Subedar with effect from 1st January, 2020.
24. No. 405135 Havildar Sabir Ahmad of 143 Wing Chitral Scouts (Settle District) with effect from 21st March, 2020 from the date of qualification on creation of vacancy in Battalion System in Settle District with effect from 1st January, 2019.
25. No. 405215 Havildar Shafiq Ahmed of 141 Wing Chitral Scouts (Settle District) with effect from 11th April, 2020 from the date of qualification *vice* No. 404553 Naib Subedar Nasir Ullah Khan promoted Subedar with effect from 1st April, 2020.
26. No. 203536 Havildar Fazal Qayyum of Signal Establishment Tirah Rifles with effect from 14th April, 2020 *vice* No. 1200162 Naib Subedar Wahid Khan promoted Subedar with effect from 14th April, 2020.
27. No. 802569 Havildar Mahmood Khan of 215 Wing Tirah Rifles (Settle District) with effect from 1st April, 2020 *vice* No. 303410 Naib Subedar Aslam Khan transferred to Headquarters Wing Tirah Rifles on Extra Regiment Employment with effect from 1st April, 2020.

AMENDMENTS

The following amendments at Serial No. 18 of our Gazette Notification No. 22/Prom/33/X/RW dated 10th October, 2020 may please be made:-

**TO BE NAIB SUBEDAR ON PROBATION OF SIX MONTHS**

**Read**

No. 703236 Havildar Ali Rehman of 166 Wing Bara Rifles (Settle District) with effect from 20th January, 2020 *vice* No. 1200743 Naib Subedar Niamat Gul promoted Subedar with effect from 1st June, 2019.

**For**

No. 703236 Havildar Ali Rehman of 166 Wing Bara Rifles (Settle District) with effect from 20th January, 2020 *vice* No. 1200743 Naib Subedar Niamat Gul promoted Subedar with effect from 20th January, 2020.

MUHAMMAD IMRAN, *Lieutenant Colonel*.  
Officer Incharge Records.

Dera Ismail Khan, the 18th November, 2020

**No. 31/1/Cfm/X/RW.**—On completion of probationary period of six months, the undermentioned Junior Commissioned Officers are confirmed in their present rank from the date as noted against each:-

1. No. 702431 Subedar Major Sadat Shah, Mohmand of Kurram Militia with effect from 3rd September, 2020.
2. No. 702715 Subedar Bughdad Shah, Mohmand of Kurram Militia with effect from 16th November, 2019.
3. No. 103698 Subedar Aliman, Afridi (Signal Establishment) of Kurram Militia with effect from 19th February, 2019.
4. No. 80750 Subedar Hamid Nawaz, Khattak (Mechanical Transport Establishment) of Kurram Militia with effect from 24th August, 2019.
5. No. 702488 Subedar Naseer Khan, Mohmand of Kurram Militia with effect from 3rd September, 2020.
6. No. 303045 Subedar Guldar Ali, Orakzai of South Waziristan Scouts with effect from 16th November, 2019.
7. No. 302869 Subedar Mubarak Shah, Kundi of South Waziristan Scouts with effect from 17th October, 2020.
8. No. 203025 Subedar Samin Ullah, Khattak of Shawal Rifles with effect from 12th September, 2020.





9. No. 104871 Naib Subedar Muhammad Afzal, Afridi (Field Battery) of Kurram Militia with effect from 18th August, 2020.
10. No. 104611 Naib Subedar Sajid Ali, Orakzai (Field Battery) of Kurram Militia with effect from 16th August, 2020.
11. No. 104610 Naib Subedar Muhammad Amin, Afridi of Kurram Militia with effect from 21st September, 2020.
12. No. 204770 Naib Subedar Minar Gul, Orakzai of Tochi Scouts with effect from 1st February, 2020.
13. No. 304161 Naib Subedar Akbar Jan, Khattak of South Waziristan Scouts with effect from 4th October, 2020.
14. No. 602211 Naib Subedar Amir Khan, Bhattani of Thall Scouts with effect from 5th September, 2019.
15. No. 602353 Naib Subedar Asmat Ullah, Bhattani of Thall Scouts with effect from 16th November, 2019.
16. No. 602625 Naib Subedar Mushtaq Nabi, Afridi (Signal Establishment) of Thall Scouts with effect from 10th June, 2020.
17. No. 602695 Naib Subedar Zia Ullah, Khattak of Thall Scouts with effect from 5th May, 2020.
18. No. 603235 Naib Subedar Manzoor Ali, Yousafzai of Thall Scouts with effect from 17th July, 2020.
19. No. 505063 Naib Subedar Naveed Ullah, Wazir of Shawal Rifles with effect from 15th April, 2020.
20. No. 305553 Naib Subedar Momin Khan, Kundi of Shawal Rifles with effect from 27th June, 2020.
21. No. 105204 Naib Subedar Muhammad Arshad, Yousafzai of Shawal Rifles with effect from 15th October, 2020.
22. No. 405341 Naib Subedar Ghulam Ishaq, Chitrali of Badar Rifles with effect from 18th April, 2020.
23. No. 1103570 Naib Subedar Akbar Ali, Bhattani (Signal Establishment) of Badar Rifles with effect from 20th November, 2019.
24. No. 506301 Naib Subedar Wilayat Shah, Yousafzai of Badar Rifles with effect from 18th April, 2020.

OFFICE OF THE INSPECTOR GENERAL OF POLICE

[NATIONAL HIGHWAYS & MOTORWAY POLICE]

Islamabad, the 28th September, 2020

**No. NHMP-1(21)/Addl.IG(NR)/2020/373.**—Consequent upon transfer from PLHQ Zone and to North Region *vide* Central Police Office Notification No. NHMP-40(10)/19/HRM/PLHQAPO/1825 dated 23rd September, 2020, following postings/transfers orders are hereby issued with immediate effect and until further orders:-

S. No.	Name of Officers	From	To
1.	IP/SPO Muhammad Afzal, S-1547	North Region	Motorway Zone
2.	IP/SPO Ashfaq Ahmed, S-1160		North Zone

2. The above mentioned officers are hereby directed to report their new place of posting immediately.

ABBAS HUSSAIN MALICK, PSP.  
Additional Inspector General.

Karachi, the 30th September, 2020

**No. DIG/S/N-5/NHMP/HRM(46)/2920.**—DSP/CPO (BS-17) Israr Ali of Beat-LEW, Karachi Sector-III (Jamshoro), is hereby granted six (06) days casual leave from 10th October, 2020 to 15th October, 2020 on recommendation of the Acting Sector Commander South-III, Jamshoro.

IP/SPO (BS-16) Muhammad Ayaz Awan, Admin Officer of Beat-LEW will look after the work of CPO-LEW Karachi during leave period of officer in addition to his own duties.

MATLOOB AHMAD, PSP.  
Deputy Inspector General.

Islamabad, the 28th September, 2020

**No. NHMP-42(7)/2019/HRM/SPO/1867.**—SPO Muhammad Anwar S/o. Muhammad Nazeer presently serving in NHMP on deputation basis and posted in N-5 (South) Zone is hereby repatriated from National Highways & Motorway Police (NHMP) to his parent department *i.e.* Sindh Police, in his substantive rank and relevant pay & allowances upon completion of maximum deputation period and on his own request.

SOHAIL SABIR, *Lieutenant Colonel.*  
For Inspector General.

The above named officer shall be relieved by Zonal Office *vide* Daily Diary (Roznamcha) maintained at Zonal





Office wherein directions be conveyed to concerned Sector/ Beat Commander for his formal relieving. However, LPC be issued after receipt of uniform articles, Arms & Ammunition and departmental E-Card issued to the officers and clearance from all concerned sections including R&W Fund.

This issues with the approval of Inspector General of Police, NHMP.

**No. NHMP-42(7)/2019/HRM/SPO/1866.**—SPO Khuda-e-Rahim S/o. Ghous Buksh presently serving in NHMP on deputation basis and posted in West Zone is hereby repatriated from National Highways & Motorway Police (NHMP) to his parent department *i.e.* Balochistan Police, in his substantive rank and relevant pay & allowances upon completion of maximum deputation period and on his own request.

The above named officer shall be relieved by Zonal Office *vide* Daily Diary (Roznamcha) maintained at Zonal Office wherein directions be conveyed to concerned Sector/ Beat Commander for his formal relieving. However, LPC be issued after receipt of uniform articles, Arms & Ammunition and departmental E-Card issued to the officers and clearance from all concerned sections including R&W Fund.

This issues with the approval of Inspector General of Police, NHMP.

**No. NHMP-42(7)/2019/HRM/SPO/1868.**—SPO Altaf Qadir (PC-31, PTC-60) presently serving in NHMP on deputation basis and posted in N-5 (North) Zone is hereby repatriated from National Highways & Motorway Police (NHMP) to his parent department *i.e.* Punjab Police, in his substantive rank and relevant pay & allowances due to bad health condition as well as on completion of maximum deputation period and on his own request.

The above named officer shall be relieved by Zonal Office *vide* Daily Diary (Roznamcha) maintained at Zonal Office wherein directions be conveyed to concerned Sector/ Beat Commander for his formal relieving. However, LPC be issued after receipt of uniform articles, Arms & Ammunition and departmental E-Card issued to the officers and clearance from all concerned sections including R&W Fund.

This issues with the approval of Inspector General of Police, NHMP.

**No. NHMP-39(5)/20/HRM/O.R/SPO/1869.**—IP/SPO Zaiwar Khan, S-1072 is hereby transferred from N-5 (Central) Zone to Motorway Zone with immediate effect and until further orders.

The above mentioned officer shall be relieved immediately with the direction to report at his new place of posting within actual permissible travelling time as provided in Circular issued *vide* No. NHMP-2(4)/12/SOP/Estt/1385 dated 22nd July, 2015.

Upon relieving of the officer, his duly completed and updated Service Record & Last Pay Certificate (LPC) be sent to Motorway Zone, within 07 days.

This issues with the approval of Inspector General of Police, NHMP.

Islamabad, the 29th September, 2020

**No. NHMP-26(10)/20/HRM/APO/1876.**—Following officers are hereby transferred and posted to the Zones as mentioned against their names, with immediate effect and until further orders:-

S.#	Rank, Name of Officers	From	To
1.	IP/SPO Mehmood-ur-Rehman S/o. Haq Nawaz	PLHQ Zone	N-5 (North) Zone
2.	IP/SPO Shahzad Zafar Hashmi S-792	N-5 (North) Zone	PLHQ Zone (for further posting as Staff Officer to AIG Finance)

2. The above mentioned officers shall be relieved immediately with the direction to report at their new place of posting within actual permissible travelling time as provided in Circular issued *vide* No. NHMP-2(4)/12/SOP/Estt/1385 dated 22nd July, 2015. Upon relieving of these officers from respective zones, their duly completed and updated Service Record alongwith LPCs be sent to the receiving zone.

3. This issues with the approval of Inspector General of Police, NHMP.

FAZL-I-HAMID, PSP.  
Assistant Inspector General.

\_\_\_\_\_  
Lahore, the 28th September, 2020

**No. NHMP/Addl-IGP(CR)/PSO/20/889.**—IP/SPO Muhammad Aslam, S-1336 (BS-16), of M-5 Zone, is hereby transferred and posted to M-4 Zone with immediate effect and until further orders.

The above mentioned officers shall be relieved immediately with the direction to report at his new place of posting within actual permissible travelling time as provided in circular issued *vide* No. NHMP-2(4)/12/SOP/Estt./1385 dated 22nd July, 2015.

Upon relieving of the officer, his duly completed and updated Service Record and Last Pay Certificate (LPC) be sent to concerned zone immediately.

No TA/DA will be admissible.





This issues with the approval of the Additional Inspector General of Police, NHMP (Central Region), Lahore.

ATIF ALI CHAUDHARY, *DSP/CPO*.  
SO to Additional Inspector General.

---

PAKISTAN BUREAU OF STATISTICS

Islamabad, the 25th November, 2020

**No. PBS.IBD.P-2(21)/2014-262.**—Having exercised the option for encashment of his leave preparatory to retirement in accordance with Finance Division O.M. No. F.1(73)R-4/84 dated 18th December, 1984 amended *vide* S.R.O 70(KE)/2012 dated 29th August, 2012 and with the approval of Secretary PD&SI/Chief Statistician, Mr. Ismail Khan, Deputy Director General (BS-20), Pakistan Bureau of Statistics, Islamabad is granted encashment of 365 days with effect from 10th August, 2020 to 9th August, 2021 in lieu of 365 days LPR.

Mr. Ismail Khan, Deputy Director General (BS-20), shall stand retired from Government Services with effect from 9th August, 2021. His date of birth is 10th August, 1961.

**No. PBS.IBD.P-12(43)/2019-259.**—In pursuance of this Bureau's Office Order No. PBS.RS.4(25)/91-T-296 dated 13th November, 2020, Mr. Ammad Arif, Data Processing Assistant (BS-16), Pakistan Bureau of Statistics, Islamabad has relinquished the charge of the post on 19th November, 2020 to join his duty at PBS, Karachi.

**No. PBS.IBD.P-11(19)/2013-258.**—With the approval of Member (RM), Mr. Mudasir Akhtar, Data Processing Officer (BS-17) (Personal No. 50069159) PBS, Islamabad has been granted 15 days R&R (in lieu of 10 days LFP) with effect from 23rd November, 2020 to 7th December, 2020, with permission to prefix weekly holidays falling on 21st, 22nd November, 2020, subject to leave admissibility certificate from AGPR, Islamabad.

He is expected to return to the same post and station on expiry of the leave.

Islamabad, the 26th November, 2020

**No. PBS.IBD.P-4(209)/2007-263.**—With the approval of Member (RM), Mr. Tahir-ul-Islam, Statistical Officer (BS-17) (Personnel # 50088532), PBS, Islamabad has been granted 26 days leave on full pay (LFP) with effect from 7th September, 2020 to 2nd October, 2020 with permission to prefix and suffix weekly holidays falling on 5th, 6th September and 3rd, 4th October, 2020 respectively subject to leave admissibility certificate from AGPR, Islamabad.

He assumed charge on 5th October, 2020 at the same post and station on expiry of the leave.

Islamabad, the 30th November, 2020

**No. PBS.IBD.P-4(256)/2011-269.**—With the approval of Director (Admn), Mr. Omer Farooq, Statistical Officer (BS-17) (Personnel # 50143599), PBS, Islamabad has been granted 10 days leave on full pay (LFP) with effect from 16th November, 2020 to 25th November, 2020, with permission to prefix weekly holidays falling on 14th, 15th November, 2020 respectively subject to leave admissibility certificate from AGPR, Islamabad.

He assumed charge on 26th November, 2020 at the same post and station on expiry of the leave.

SADIA CHAUDHRY,  
Assistant Director (Admn).

Islamabad, the 24th November, 2020

**No. 5(105/89-PCO(Admn)-1229.**—Having exercised the option for encashment of his leave preparatory to retirement in terms of Rule 18-A of the Revised Leave Rules, 1980 amended *vide* Finance Division's S.R.O. 70(KE)/2012 dated 29th August, 2012 and with the approval of competent authority Mr. Muhammad Hafeez, Assistant Census Commissioner (BS-17), Pakistan Bureau of Statistics (PCO Wing), Karachi is granted encashment (in lieu of 365 days LPR) with effect from 15th November, 2020 to 14th November, 2021.

**No. 5(105/89-PCO(Admn)-1229.**—Mr. Muhamamd Hafeez, Assistant Census Commissioner (BS-17), Pakistan Bureau of Statistics (PCO Wing), Karachi shall stand retired from Government Service on attaining the age of superannuation on 14th November, 2021 (His date of birth is 15th November, 1961).

Islamabad, the 26th November, 2020

**No. PBS.IBD.P-2(23)/2019-1236.**—Having exercised the option for encashment of his leave preparatory to retirement in terms of Rule 18-A of the Revised Leave Rules, 1980 amended *vide* Finance Division's S.R.O 70(KE)/2012 dated 29th August, 2012 and with the approval of the Chief Statistician/Secretary PD&SI, Mr. Muhammad Iqbal Rana, Deputy Director General (C) (BPS-20), Pakistan Bureau of Statistics, DP. Centre Lahore is granted encashment of LPR of 365 days, in lieu of 365 days leave with effect from 20th October, 2020 to 19th October, 2021.

**No. PBS.IBD.P-2(23)/2019-1236.**—With the approval of Chief Statistician/Secretary PD&SI, Mr. Muhammad Iqbal Rana, Deputy Director General (C) (BPS-20), Pakistan Bureau of Statistics, DP. Centre, Lahore shall stand retire from Government Service on attaining the age of superannuation on 19th October, 2021. His date of birth is 20th October, 1961.

SAFIA BEGUM,  
Statistical Officer (Admn-III).





Karachi, the 25th November, 2020

**No. FBS.AP.P-15(10)/2012-03.**—In pursuance of Pakistan Bureau of Statistics (HQ), Islamabad's Notification No. PBS.HQ.FA.P(747)/16-1179 dated 11th November, 2020 and with the approval of Deputy Director General (Incharge), PBS, Karachi, the suspension of Mr. Muhammad Sohail Sheikh, Data Processing Assistant (BPS-16), is hereby terminated and posted at Data Processing Centre, PBS, Karachi, till further orders.

FARZANA SIDDIQUE,  
Superintendent (Admn).

PAKISTAN INSTITUTE OF MEDICAL SCIENCES

Islamabad, the 20th November, 2020

**No. F.1-14/2019-ADS(Admin)IH.**—Dr. Wajiha Walayat, Assistant Dental Surgeon (BS-17) has been granted 90 days maternity leave with full pay with effect from 2nd November, 2020 to 30th January, 2021.

This issues with the approval of Executive Director.

**No. PF.0023-R/AD/Admin-PIMS.**—Syed Jamil Hussain Sherazi, Assistant Director (BS-17) has been granted 13 days Medical leave with effect from 9th November, 2020 to 21st November, 2020.

This issues with the approval of Executive Director.

Islamabad, the 23rd November, 2020

**No. PF.0075-R/A.P/Admin-PIMS.**—Dr. Amir Saleem, Assistant Professor of Gastroenterology has been granted 13 days Medical leave with full pay with effect from 26th October, 2020 to 31st October, 2020 and 2nd November, 2020 to 8th November, 2020 due to Corona and Dengue disease.

This issues with the approval of Executive Director.

DR. M.IQBAL KHAN DURRANI,  
Deputy Executive Director.

[MOTHER & CHILD HEALTH CENTRE]

Islamabad, the 21st November, 2020

**No. F.1-1(Gen)MCH/Admin.**—Reference Explanation Letter of even number dated 23rd October, 2020 that you Ms. Razia Sultana, Charge Nurse of IH working in MCH Centre remained absent from duty with effect from 12th October, 2020 to 15th October, 2020 (04 days) without any information/perior permission. However, taking a lenient view her absence period *i.e.* 4 days is hereby treated as leave without pay and warned to the careful in future.

**No. F.7-38(WW)MCH/Admin.**—In continuation to this office notification of even number dated 16th November, 2020, leave with full pay of Ms. Welmina William, Charge Nurse of MCH Centre hereby extended for further period of 5 days leave with full pay with effect from 11th November, 2020 to 15th November, 2020. She will resume her duty on 16th November, 2020 on same place. Her personal Number, 50064272.

**No. F.1-1(Gen)MCH/Admin.**—Ms. Salma Sadiq, Charge Nurse of IH working in MCH, Centre is hereby granted 10 days leave with full pay with effect from 30th October, 2020 to 8th November, 2020.

**No. PF.2-3(SA)MCH/Admin.**—Dr. Saera Afghan, Associate Professor, Gynae of MCH, Centre is hereby granted 10 days leave with full pay with effect from 9th November, 2020 to 18th November, 2020. She will resume her duty on place on 19th November, 2020. Her personal Number 50048319.

This issues with the approval of JED.

DR. NASREEN BUTT,  
Deputy Director MCH.

PAKISTAN INSTITUTE OF TRADE AND DEVELOPMENT

Islamabad, the 26th November, 2020

**No. PITAD-Admn-3(90)92.**—In exercise of powers delegated *vide* Finance Division's O.M. No. F.3(2)Exp.III /2006, dated 13th September, 2006, I am pleased to convert the following temporary posts of Pakistan Institute of Trade and Development into permanent posts as well as transfer them from part-II to Part-I of the budget:-

S. No.	Name of Post	BPS	No. of Posts
1.	Research Associate	17	03
2.	Technical Editor	17	01
<b>Total</b>			<b>04</b>

2. It is certified that

- i. These posts have remained in existence for more than five (05) years.
- ii. The posts were created for work of permanent nature.
- iii. The nature of work is likely to continue for indefinite period.

MRS. RAHEELA TAJWAR,  
Director General.





PAKISTAN METEOROLOGICAL DEPARTMENT

Islamabad, the 26th November, 2020

**No. E-16(450)/II/1171.**—Syed Mushtaq Ali Shah, Director (BS-19), Regional Meteorological Centre, Gilgit has been granted 19 days leave on full pay from 19th October, 2020 to 6th November, 2020, with permission to prefix Saturday & Sunday from 17th October, 2020 to 18th October, 2020 and suffix Saturday, Sunday from 7th November, 2020 to 8th November, 2020, subject to admissibility.

On expiry of leave, Syed Mushtaq Ali Shah, Director (BS-19), resumed duty at the same station on 9th November, 2020.

**No. E-16(905)/1166.**—Mr. Hamid Ahmad, Assistant Programmer (BPS-16), Regional Meteorological Centre, Lahore has relinquished the charge of his post on 14th November, 2020 on account of his retirement from Government Service with effect from 15th November, 2020 on attaining the age of superannuation being his date of birth 15th November, 1960.

Islamabad, the 27th November, 2020

**No. E-16(603)/1212.**—Mr. Hidayatullah Khan, Assistant Meteorologist (BPS-16), Climate Data Processing Centre, Karachi has relinquished the charge of his post on 5th July, 2020 on account of his retirement from Government Service with effect from 6th July, 2020 on attaining the age of superannuation being his date of birth 6th July, 1960.

MUHAMMAD SHOAIB,  
Administrative Officer.

---

TRADE DEVELOPMENT AUTHORITY OF PAKISTAN

Karachi, the 21st December, 2020

**No. TDAP.P(2176)/Estt-2007.**—In pursuance of Auditor General of Pakistan, Islamabad Notification No. 624/PAAS-

1/31/2002 dated 17th November, 2020, Mr. Akhtar Ali Qureshi, a BS-18 officer of Pakistan Audit Department, ex-Deputy Director Pakistan Audit & Accounts Academy, Karachi and presently serving as Deputy Director, Trade Development Authority of Pakistan (TDAP), Karachi on deputation basis is granted leave encashment *i.e.* 365 day's in lieu of one year L.P.R. with effect from 2nd March, 2020 to 1st March, 2021.

The officer shall stand retired from Government Service on attaining the age of superannuation on 1st March, 2021.

Karachi, the 22nd December, 2020

**No. TDAP.P(2363)/Estt-2020.**—The Secretary, Trade Development Authority of Pakistan has been pleased to grant sixty (60) days Earned Leave on full pay with effect from 28th December, 2020 to 25th February, 2021 with permission to leave the station to Ms. Muneeba Nawaz, Assistant Director, TDAP, Lahore.

KALEEMULLAH MEMON,  
Deputy Director (Estt).

Karachi, the 31st December, 2020

**No. TDAP.P(1894)/Estt.95.**—In pursuance of Finance Division's O.M. No. 1(12)/Imp/2016-333 dated 1st July, 2016, the Secretary, Trade Development Authority of Pakistan has been pleased to grant Qualification Pay @ Rs. 1500/- with effect from 25th July, 2020 to Mr. Asim Tauqir, a BS-19 officer of Commerce & Trade Group/Director, Trade Development Authority of Pakistan, Karachi on completion of his 27th Senior Management Course (SMC) at National Institute of Management, Karachi,

ALTAF HUSSAIN,  
Assistant Director (Estt-I).





# The Gazette of Pakistan

PUBLISHED BY AUTHORITY

KARACHI, WEDNESDAY, FEBRUARY 17, 2021

## PART V

Notifications, etc., issued by The Patent Office

### NEW APPLICATIONS FOR THE PATENTS

The dates shown in the crescent brackets are the dates claimed under section 86 of the Patents Ordinance 2000.

#### 15th June, 2020

379/2020 LAKSHMI MACHINE WORKS LTD., India. (Priority 1st July, 2019, IN).—“CAN EXCHANGING APPARATUS AND A METHOD THEREOF FOR A TEXTILE SPINNING PREPARATORY MACHINE”.

380/2020 PFIZER INC., and CTXT PTY LTD, Australia (Priority 18th June, 2019, US).—“Benzisoxazole Sulfonamide Derivatives”.

381/2020 Merck & Co., Inc., U.S.A. (Priority 12th August, 2008, US).—“SUBSTITUTED 1,2,4-TRIAZOLYL-DODECAHYDRO-TETRAMETHYL-4H-1,4a-PROPANO-2H-PHENANTHRO[1,2-c]PYRAN-7-CARBOXYLIC ACID”.

382/2020 MUHAMMAD BILAL KHAN and MUHAMMAD USMA QURESHI, Pakistan.—“A NOVEL MACHINE FOR MARKETING PRODUCT ON SHELF”.

383/2020 Zeeshan Khatri and Farooq Ahmed, Pakistan.—“Water repellent and washable Nanofiber Hybrid Face Mask for filtering Covid-19-Method of making and use thereof”.

384/2020 Engr. Ali Imran, Engr. Abdullah Saqib, Mr. Imran Qureshi & Dr. Quratulain Syed, Pakistan.—“Development of Disinfection Corridor utilizing Mist Fan Technology”.

385/2020 Habib Nasir and Anum Zahir, Pakistan.—“Tetraphenylporphyrin Functionalized Pristine Graphene Based Nanosensors for Electrochemical Detection of Trace Nitrobenzene”.

386/2020 Habib Nasir, Syeda Aqsa . Batool Bukhari and Lujun Pan Chinese, Pakistan.—“Electrochemical Sensing of Catechol Based on Carbon Nanocoils/Zinc-Tetraphenyl”

387/2020 AKMAL JAVED (Retd) and PERVAIZ IQBAL, Pakistan.—“Preparation of Synthetic Pulp for edible juices and Making of Synthetic Pulp”.

#### 16th June, 2020

388/2020 Deciphera Pharmaceuticals, LLC., U.S.A. (Priority 17th June, 2019, US).—“AMINO-PYRIMIDINE AMIDE AUTOPHAGY INHIBITORS AND METHODS OF USE THEREOF”.

389/2020 VIIV HEALTHCARE UK (No. 5) LIMITED, United Kingdom (Priority 19th June, 2019, US).—“INHIBITORS OF HUMAN IMMUNODEFICIENCY VIRUS REPLICATION”.

390/2020 National University of Sciences & Technology (NUST), Pakistan.—“Liquid hand sanitizer for General Public”.

391/2020 National University of Sciences & Technology (NUST), Pakistan.—“Gel-based Hand sanitizer”.

#### 17th June, 2020

392/2020 Saurer Spinning Solutions GmbH & Co. KG, Germany (Priority 19th June, 2019, DE).—“A TEXTILE MACHINE HAVING A PLURALITY OF WORKSTATIONS AND A METHOD FOR MONITORING A TEXTILE MACHINE A PLURALITY OF WORKSTATIONS”.

- 393/2020 Saurer Spinning Solutions GmbH & Co. KG, Germany (Priority 19th June, 2019, DE).—“FIBRE BAND OPENING DEVICE FOR AN OPEN-END SPINNING DEVICE AND FEED TRAY FOR THE FIBRE BAND OPENING DEVICE”.
- 394/2020 ELI LILLY AND COMPANY, U.S.A. (Priority 28th June, 2019, US).—“GLUCAGON-LIKE PEPTIDE 1 RECEPTOR AGONISTS”.
- 395/2020 Visterra, Inc., U.S.A. (Priority 17th June, 2019, US).—“Humanized antibody molecules to CD138 and uses thereof”.
- 396/2020 Khawar Nehal, Pakistan.—“Corner sensor and alert system for transport vehicles”/
- 18th June, 2020**
- 397/2020 Ch. Shahid Rahim, CEO, Agritec Industries Pvt. Ltd, Pakistan.—“AGRITEC ULV SPRAYER”.
- 398/2020 SHENZHEN STOCK EXCHANGE; China (Priority 24th September, 2019, CN).—“PROCESSING METHOD AND PROCESSING DEVICE FOR SENDING MESSAGES, AND COMPUTER READABLE STORAGE MEDIUM”.
- 399/2020 G1 Therapeutics, Inc., Pakistan (Priority 18th June, 2019, US).—“MEANS FOR ENHANCEMENT OF ANTI-TUMOR IMMUNITY IN CANCER PATIENTS”.
- 400/2020 SHENZHEN TRANSSION HOLDINGS CO., LTD.; China (Priority 29th September, 2019, CN).—“METHOD FOR IMPLEMENTING AUGMENTED REALITY, MOBILE TERMINAL, AND STORAGE MEDIUM”.
- 401/2020 Hisham Saeed Aldajani son of Hisham Saeed Abdullah Abdulrahman Aldajani, Saudi Arabia.—“Device”.
- 402/2020 Dr. Abdul Rehman (Assistant Professor), Pakistan.—“MULTIFUNCTION SUGARCANE HARVESTING MACHINE”.
- 403/2020 SANTONI S.P.A., Italy (Priority 19th June, 2019, IT).—“Circular knitting machine with system for offsetting the plate of the needles with respect to the cylinder of the needles”.
- 404/2020 SANTONI S.P.A., Italy (Priority 20th June, 2019, IT).—“Turning device for tubular knitted items and method for turning tubular knitted items”.
- 405/2020 Engr. Ali Imran, Engr. Abdullah Saqib, Mr. Imran Qureshi & Mr. Muhammad Azhar, Pakistan.—“Paddle Based Mechanical Sanitizer Dispenser”.
- 19th June, 2020**
- 406/2020 JVCKENWOOD Corporation, Japan (Priority 25th June, 2019, JP).—“MOVING PICTURE CODING DEVICE, MOVING PICTURE CODING METHOD, MOVING PICTURE CODING PROGRAM, MOVING PICTURE DECODING DEVICE, MOVING PICTURE DECODING METHOD, AND MOVING PICTURE DECODING PROGRAM”.
- 407/2020 THE POPULATION COUNCIL INC., U.S.A. Priority 21st June, 2019, US).—“SYSTEM FOR PROVIDING BIRTH CONTROL”.
- APPLICATION ACCEPTED**
- Notice is hereby given that the person interested in opposing the grant of Patents to any of the applications referred to below at any time within four months from the date of this Patents’ journal may give notice at the Patent Office on the prescribed Form P-7 of the Patents Rules 18(1) of 2003.
- The six figures number shown in the right hand side are those given to applications on acceptance of the complete specification under which the specification will be printed and subsequent proceeding taken.
- The figures shown within square brackets after the title of inventions indicate their classification index at acceptance.
- Typed copies of the specification which are to open to public inspection can be supplied by the Patent Office on payment of the prescribed charges which may be ascertained on application to the office.
- 282/2009 DUKE UNIVERSITY and IMMUNOLIGHT LLC, U.S.A.—“A pharmaceutical composition for producing a desired change in a target structure”.
- A61K41/00, A61N5/10 & A61N5/06.
- 143510
- The present invention relates to a pharmaceutical composition for producing a desired change in a target structure, comprising: an energy modulation agent, a pharmaceutically acceptable carrier and optionally a plasmonics-active agent, wherein the energy modulation agent and pharmaceutically acceptable carrier are present in a ratio sufficient for administration of the composition by a desired administration route;

wherein the energy modulation agent receives higher energy X-rays and emits electromagnetic in lower energy UV and is selected from fluorescent molecules or luminescent molecules or phosphorescent molecules, and wherein the composition does not comprise an activatable pharmaceutical agent.

405/2010 BAYER CROPSOURCE AG, Germany.—“N-BENZYL-N-CYCLOPROPYL-3-(DIHALO-METHYL)-5-HALO-1-METHYL-PYRAZOLE-4-CARBOXAMIDE COMPOUND”.

A01N43/56, C07D401/12 & C07D231/16.

143511

The present invention relates to pyrazole carboxamide compound of formula (I)

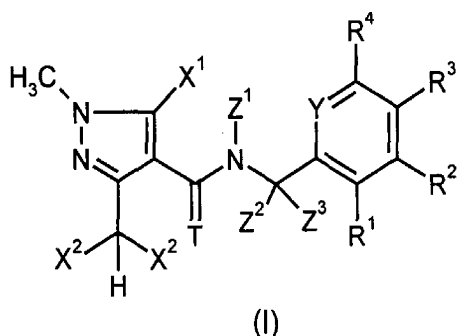

wherein Y represents CR<sup>5</sup> or N, T represents S or O, X<sub>1</sub> and X<sub>2</sub> represent a chlorine or a fluorine atom, and Z<sub>1</sub> represents a substituted or non-substituted cyclopropyl.

592/2014 Ishihara Sangyo Kaisha, Ltd. and NIHON NOHYAKU CO., LTD, Japan.—“Water-Based Pesticidal Suspension Comprising (a) Flonicamid, (b) Buprofezin, (c) Polycarboxylate, (d) Surfactant (e) Sodium Alkyl naphthalenesulfonate condensed with formaldehyde and water”.

A01N43/40, A01N25/30 & A01P7/04.

143512

The present invention provides a water-based pesticidal suspension comprising (a) flonicamid, (b) buprofezin, (c) a polycarboxylate, (d) at least one sulfonate type surfactant selected from the group consisting of an alkyl sulfo-succinate, a lignosulfonate, a C<sub>8-18</sub> alkyl benzene sulfonate and a C<sub>8-18</sub> alkyl diphenyl ether disulfonate, (e) a sodium alkyl naphthalenesulfonate condensed with formaldehyde, and water. The mean volume diameter of particles of active ingredients (a) flonicamid and (b) buprofezin, is from 0.1 μm to 20 μm. The present invention solves the problem of the prior art such that if a water-based

pesticidal suspension containing (a) flonicamid and (b) buprofezin as active ingredients is stored for a long period of time, the active ingredient particles will grow and become coarse during storage, and a stable suspension is hardly obtained.

150/2015 Merck Sharp & Dohme Corp., U.S.A.—“4'-SUBSTITUTED NUCLEOSIDE REVERSE TRANSCRIPTASE INHIBITOR COMPOUND”.

C07D487/04, A61K31/7064, A61P11/16 & C07D487/04.

143513

The invention relates to a compound of structural Formula I

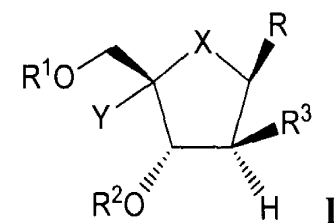

wherein:

R is

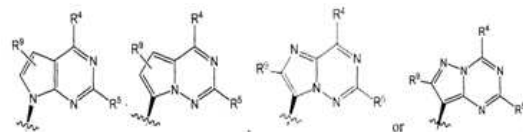

X is O;

Y is -C≡C-R<sup>8</sup> or -C≡N;

Whereas the substituents including R<sup>1</sup> to R<sup>9</sup>, R<sup>x</sup> and R<sup>y</sup> are described in description and claims.

The present invention also provides a pharmaceutical composition comprising a 4'-substituted nucleoside compound for inhibition of HIV reverse transcriptase, for the treatment or prophylaxis of infection by HIV, or for the treatment, prophylaxis or delay in the onset of AIDS.

357/2015 CHIESI FARMACEUTICI S.p.A., Italy.—“INDOLIZINE AS PHOSHOINOSITIDE 3-KINASE INHIBITOR”.

C07D473/02, C07D471/04, C07D487/04, A61K31/519, A61K31/52, A61P37/00, A61P11/00 & A61P29/00.

143514

The invention relates to novel a compound of general formula (I)

143516

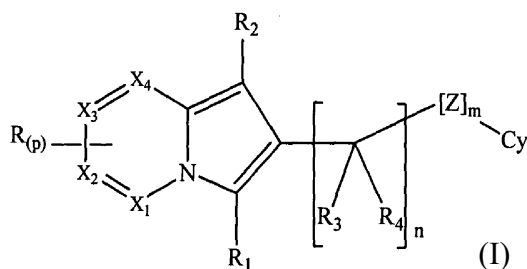

wherein  $X_1$ ,  $X_2$ ,  $X_3$  and  $X_4$ , are all CH groups  
 $R$ ,  $R_1$ ,  $R_2$ ,  $R_3$ ,  $R_4$ ,  $Cy$ ,  $Z$ ,  $m$ ,  $n$  and  $p$  are as defined in therein, which are inhibitor of phosphoinositide 3- kinase, and composition containing them.

668/2015 ENI S.p.A., Italy.—“SAFETY VALVE FOR EXTRACTION WELLS OF HYDRO-CARBONS”.

E21B29/08 & E21B29/00.

143515

A safety valve (10) for extraction wells is described, configured for being installed on the head (11) of a well and for enclosing a portion of a tubular material (12) inserted inside the well. The tubular material (12) is internally hollow and designed for containing and transporting fluids and other substances extracted from the well. The safety valve (10) is provided with a central hole through which the tubular material (12) passes and comprises a blocking system (14, 16), configured for firmly keeping the tubular material (12) to be cut fixed with respect to the safety valve (10), a cutting and closing group (18) configured for cutting and closing the well under certain operative conditions, and a sealing mechanism (20), designed for effecting a watertight closing of the well, after the cutting. The cutting and closing group (18) consists of a hole saw (26) housed in a respective chamber of said cutting and closing group (18). The hole saw (26) is rotated by a motorized actuation means (28) and is configured for moving in a controlled mode along a substantially orthogonal direction with respect to the development direction of the well.

548/2016 Janssen Pharmaceuticals, Inc., and Katholieke Universiteit Leuven, U.S.A.—“1-(substituted- 1H-indol-3-yl)-2-(4-fluoro-2-(2-hydroxyethoxy)-phenyl)-2-((3-methoxy-5-(methylsulfonyl) phenyl)amino)ethanones with anti-dengue activity”

C07D209/12, A61K31/454 & A61P31/14.

The present invention relates to a compound of formula (I)

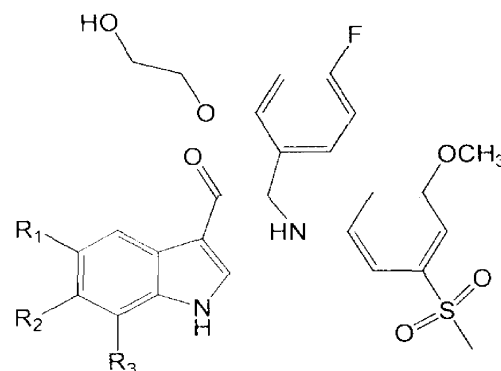

a stereo-isomeric form, solvate or polymorph thereof; said compound is selected from the group

wherein:

- $R_1$  is H,  $R_2$  is F or Cl and  $R_3$  is H or  $CH_3$ ;
- $R_1$  is F,  $R_2$  is F and  $R_3$  is H;
- $R_1$  is  $CH_3$ ,  $R_2$  is  $OCH_3$  and  $R_3$  is H;
- $R_1$  is  $CH_3$ ,  $R_2$  is F and  $R_3$  is H;
- $R_1$  is  $CH_3$ ,  $R_2$  is H and  $R_3$  is F;
- $R_1$  is Cl,  $R_2$  is H and  $R_3$  is  $CH_3$ ;
- $R_1$  is  $OCF_3$ ,  $R_2$  is H or  $OCH_3$  and  $R_3$  is H and
- $R_1$  is  $OCF_3$ ,  $R_2$  is H and  $R_3$  is  $CH_3$

for use as a medicine, more preferably for use as a medicine to treat or prevent dengue viral infections.

The present invention furthermore relates to pharmaceutical composition or combination preparation of the compound, to the composition or preparation for use as a medicine, more preferably for the prevention or treatment of dengue viral infections. The invention also relates to process for preparation of the compound.

700/2016 LONATI S.P.A., Italy.—“Turning device for turning inside-out knitted tubular articles with pockets”

D04B9/40 & D04B15/92.

143517

A turning device for knitted tubular articles, particularly for turning inside-out tubular articles with pockets that protrude from the lateral surface thereof. The turning device in question comprises a main supporting structure (2) which supports a tubular body (3) arranged with its axis (4) substantially vertical. The tubular body (3) has its upper axial end (3a) beveled along a plane that is inclined with respect to its axis (4). The turning device comprises first actuation means (5) which can be activated to perform a translation of the

tubular body (3) along its axis (4) with respect to the main supporting structure (2). The tubular body (3) is insertable, with its upper axial end (3a), through an axial end of a tubular article (60) in order to turn it inside out. The turning device in question comprises second actuation means (6, 6a) which can be activated to rotate the tubular body (3) about its own axis (4), through an angle of preset breadth, with respect to the main supporting structure (2).

143519

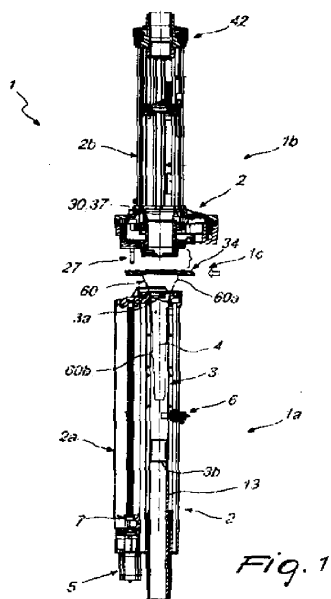

40/2017 QUALCOMM INCORPORATED, U.S.A.—  
“NARROW BAND ACK/NACK TRANSMISSION”.  
H04L1/16.

143518

The present disclosure provides various modifications to existing techniques for transmitting acknowledgement (ACK) and/or negative acknowledgement (NACK) in a narrow band communications system. For example, in a first aspect, an apparatus receives a downlink transmission and transmits a single tone ACK on an ACK channel using time-spreading. In another aspect, an apparatus determines whether an ACK has been received from a user equipment (UE) within a threshold amount of time, and when an ACK has not been received from the UE for at least the threshold amount of time, transmitting an indication to the UE to transmit regarding the ACK.

57/2017 QUALCOMM INCORPORATED, U.S.A.—  
“SMALL CELL & COMMUNICATION NETWORK RECONFIGURATION BASED ON WIRELESS DEVICE CAPABILITIES”.

H04W72/08 & H04W72/04.

Aspects of the present disclosure provide a scheduling entity and method of operating the scheduling entity such that the scheduling entity reconfigures/allocates its resources based on device capabilities of the wireless devices. The scheduling entity utilizes a first resource configuration to provide communications service to one or more wireless devices associated with the scheduling entity. The scheduling entity determines a change of the one or more wireless devices, wherein the change include at least one of a capability change of a wireless device, a quality of service (QoS) requirement change of a wireless device, an addition of a wireless device, or a removal of a wireless device. Based on at least one of a predetermined time of a day or the determined change, the scheduling entity reconfigures to a second resource configuration to facilitate resource utilization of the first wireless cell.

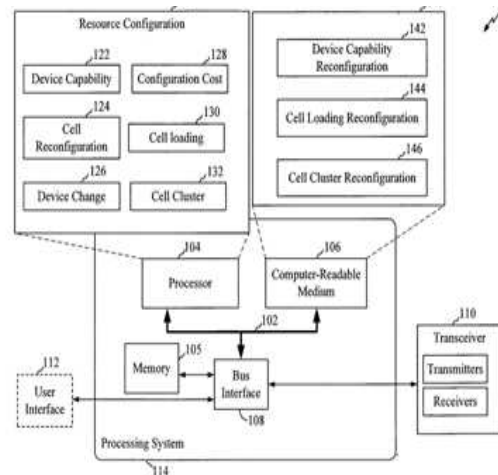

72/2017 VIIV HEALTHCARE UK (No.5) LIMITED,  
United Kingdom.—“C-3 AND C-17 MODIFIED  
TRITERPENOIDS AS HIV-1 INHIBITORS”.

C07J63/00, C12N9/50, A61K31/575,  
A61K31/56, A61K31/58 & A61P31/18.

143520

Compounds having drug and bio-affecting properties, their pharmaceutical compositions and methods of use are set forth. In particular, betulinic acid derivatives that possess unique antiviral activity are provided as HIV maturation inhibitors, as represented by compounds of Formula I:

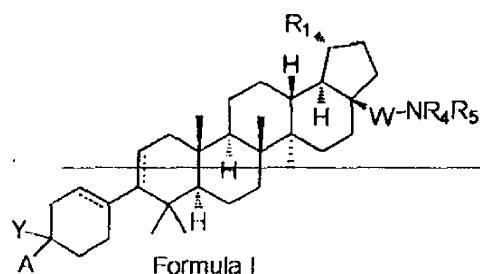

These compounds are useful for the treatment of HIV and AIDS.

143523

100/2017 FERRING B.V., Netherlands.—“Liquid Formulation of Gonadotropin”.

A61K47/18, A61K 9/08 & A61K9/00.

143521

The present invention pertains in general to the field of the stabilization of gonadotropin formulations, in particular liquid formulations of gonadotropins. The stabilization is achieved by a particular combination of excipients, preferably arginine and methionine. In a preferred embodiment, the formulation does not comprise a buffer.

430/2017 Patrick John Fitzpatrick, Canada.—“A Method and Assembly for Storing and Transporting Compressed Natural Gas”.

F17C1/00, F17C5/06, B63B25/08 & B63B 25/24.

143522

An assembly for storing and transporting compressed fluid, such as compressed natural gas (CNG) that includes; a plurality of hexagonally stacked pipe stored in a cargo hold in or on a vessel, such as a ship or barge, that includes a lower support, side supports and a forcing mechanism that presses so strongly down on the pipes that they cannot move relative to themselves or relative to the vessel on which they are placed in any service situation. The friction between each of the pipes causes the plurality of pipes to act as part of the vessel in terms of its structure. Each of the pipes in the plurality of pipes is connected to a manifold system to allow for the loading and unloading of the compressed fluid.

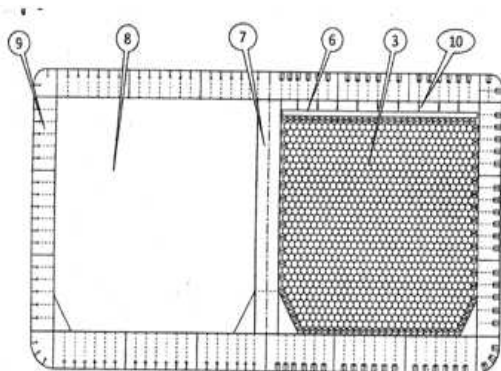

534/2018 NOVARTIS AG, Switzerland.—“4-METHYL-2-(1,1,1-TRIFLUORO-2-METHYLPROPAN-2-YL) PYRIDINE COMPOUND”.

C07D213/26.

The present invention provides a compound according to formula (1):

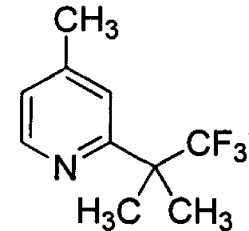

883/2018

Merck Sharp & Dohme Corp., U.S.A.—“A Pharmaceutically Acceptable Salt of 4'-Substituted Nucleoside Reverse Transcriptase Inhibitor Compound”.

C07D487/04.

143524

The invention relates to a pharmaceutically acceptable salt of a compound of structural Formula I

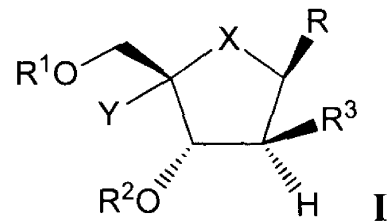

wherein:

R is

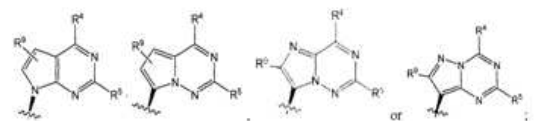

X is O;

Y is  $-\text{C}\equiv\text{C}-\text{R}^8$  or  $-\text{C}\equiv\text{N}$ ;

Whereas the substituents including R1 to R9, R<sup>X</sup> and R<sup>Y</sup> are defined in description and claims.

The present invention also provides a pharmaceutical composition comprising a 4'-substituted nucleoside compound for inhibition of HIV reverse transcriptase, for the treatment or prophylaxis of infection by HIV, or for the treatment, prophylaxis or delay in the onset of AIDS.

25/2019

FAES FARMA, S.A., Spain.—“An aqueous ophthalmic pharmaceutical composition comprising bilastine as active ingredient for allergic disorders”.

A61K31/454, A61K47/40, A61K9/00 & A61P 27/14.

143525

143527

The present invention relates to an aqueous ophthalmic pharmaceutical composition comprising:

at least 0.4% w/v but no more than 1.0% w/v of bilastine, or a pharmaceutically acceptable salt or solvate thereof, wherein the bilastine or salt or solvate thereof is completely dissolved in the aqueous ophthalmic pharmaceutical composition;

at least one  $\beta$ -cyclodextrin selected from the group consisting of unmodified  $\beta$ -cyclodextrin, C<sub>1</sub>-C<sub>6</sub> alkyl- $\beta$ -cyclodextrin, C<sub>1</sub>-C<sub>6</sub> hydroxyalkyl  $\beta$ -cyclodextrin, C<sub>1</sub>-C<sub>6</sub> carboxyalkyl- $\beta$ -cyclodextrin, carbonyl- $\beta$ -cyclodextrin, C<sub>2</sub>-C<sub>6</sub> sulfoalkylether  $\beta$ -cyclodextrin and mixtures thereof; and at least one pharmaceutically acceptable water-soluble gelling agent or an acceptable salt thereof, selected from the group consisting of hyaluronic acid, gellan gum and mixtures thereof;

and wherein the pH value of the composition is comprised between 4 and 9, both lower and upper limits of the range included.

The advantage of the invention is to provide an ophthalmic solution suitable for once-daily administration that includes high concentrations of bilastine as medicament for conditions mediated by H<sub>1</sub> histamine receptor, such as allergic disorders.

107/2019 BAYER CROPSOURCE AG, Germany.—“N-BENZYL-N-CYCLOPROPYL-3-(DIHALO-METHYL)-5-HALO-1-METHYL-PYRAZOLE-4-CARBOXAMIDE COMPOUND”.

C07D231/16.

143526

The present invention relates to a compound of formula (IIg)

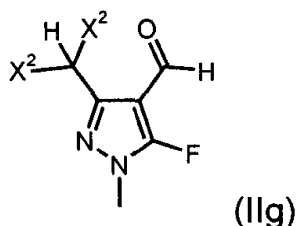

wherein X<sup>2</sup> represents a chlorine or a fluorine atom, preferably a fluorine atom.

108/2019 BAYER CROPSOURCE AG, Germany.—“N-BENZYL-N-CYCLOPROPYL-3-(DIHALO-METHYL)-5-HALO-1-METHYL-PYRAZOLE-4-CARBOXAMIDE COMPOUND”.

C07D231/16.

The present invention relates to a compound of formula (IIe)

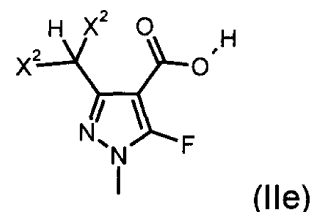

wherein X<sup>2</sup> represents a chlorine or a fluorine atom, preferably a fluorine atom.

109/2019 BAYER CROPSOURCE AG, Germany.—“PROCESS FOR THE PREPARATION OF N-BENZYL-N-CYCLOPROPYL-3-(DIHALO-METHYL)-5-HALO-1-METHYL-PYRAZOLE-4-CARBOXAMIDE COMPOUND”.

C07D231/16.

143528

The present invention relates to a process for the preparation of compounds of formula (I), (IIb), (IIc'), (IIId), (IIe), (IIIf) & (IIIg) according to the following scheme:

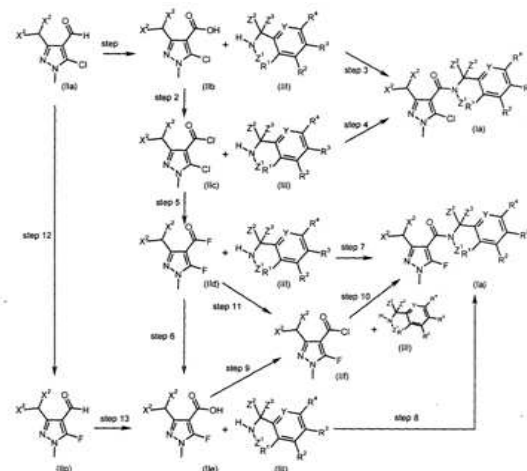

wherein

- Y represents CR<sup>5</sup>;
- X<sup>2</sup> represents a chlorine or a fluorine atom;

Z<sup>1</sup> represents a non substituted cyclopropyl or a cyclopropyl substituted by up to 2 atoms or groups which can be the same or different and which can be selected in the list consisting of halogen atoms ; cyano ; C<sub>1</sub>-C<sub>8</sub>-alkyl ; or C<sub>1</sub>-C<sub>8</sub>-halogenoalkyl comprising up to 9 halogen atoms which can be the same or different ; Z<sup>2</sup> and Z<sup>3</sup>, which can be the same or different, represent a hydrogen atom ; substituted or non substituted C<sub>1</sub>-C<sub>8</sub>-alkyl ; substituted or non substituted C<sub>2</sub>-C<sub>8</sub>-alkenyl ; substituted or

non substituted C<sub>2</sub>-C<sub>8</sub>-alkynyl ; cyano ; isonitrile ; nitro ; a halogen atom ; substituted or non substituted C<sub>1</sub>-C<sub>8</sub>-alkoxy ; substituted or non substituted C<sub>2</sub>-C<sub>8</sub>-alkenyloxy substituted or non substituted C<sub>2</sub>-C<sub>8</sub>-alkynyloxy ; substituted or non substituted C<sub>3</sub>-C<sub>7</sub>- cycloalkyl ; substituted or non substituted C<sub>1</sub>-C<sub>8</sub>-alkylsulfanyl ; substituted or non substituted C<sub>1</sub>-C<sub>8</sub>-alkylsulfonyl ; substituted or non substituted C<sub>1</sub>-C<sub>8</sub>-alkylsulfinyl ; amino ; substituted or non substituted C<sub>1</sub>-C<sub>8</sub>-alkylamino ; substituted or non substituted di-C<sub>1</sub>-C<sub>8</sub> alkylamino ; substituted or non substituted C<sub>1</sub>-C<sub>8</sub>-alkoxycarbonyl ; substituted or non substituted C<sub>1</sub>-C<sub>8</sub>-alkylcarbamoyl ; substituted or non substituted di-C<sub>1</sub>-C<sub>8</sub>-alkylcarbamoyl ; or substituted or non substituted N-C<sub>1</sub>-C<sub>8</sub>-alkyl-C<sub>1</sub>-C<sub>8</sub>-alkoxycarbamoyl ; or Z<sup>3</sup> and R<sup>1</sup> together with the consecutive carbon atoms to which they are linked form a substituted or non substituted 5-, 6- or 7-membered, partly saturated, carbo- or heterocycle comprising up to 3 heteroatoms and Z<sup>2</sup> is as herein described; or Z<sup>2</sup> and Z<sup>3</sup> together with the carbon atom to which they are linked form a substituted or non substituted C<sub>3</sub>-C<sub>7</sub> cycloalkyl; R<sup>1</sup>, R<sup>2</sup>, R<sup>3</sup>, R<sup>4</sup> and R<sup>5</sup>, which can be the same or different, represent a hydrogen atom; a halogen atom ; nitro ; cyano ; isonitrile ; hydroxyl ; sulfanyl ; amino ; pentafluoro-λ<sup>6</sup>-sulfanyl ; substituted or non substituted C<sub>1</sub>-C<sub>8</sub>-alkyl ; C<sub>1</sub>-C<sub>8</sub>-halogenoalkyl comprising up to 9 halogen atoms which can be the same or different ; substituted or non substituted C<sub>1</sub>-C<sub>8</sub>-alkylamino ; substituted or non substituted di-C<sub>1</sub>-C<sub>8</sub>-alkylamino ; substituted or non substituted C<sub>1</sub>-C<sub>8</sub>-alkoxy ; C<sub>1</sub>-C<sub>8</sub>-halogenoalkoxy comprising up to 9 halogen atoms which can be the same or different ; C<sub>1</sub>-C<sub>8</sub>-alkoxy-C<sub>1</sub>-C<sub>8</sub>-alkyl ; substituted or non substituted C<sub>1</sub>-C<sub>8</sub>-alkylsulfanyl ; C<sub>1</sub>-C<sub>8</sub>-halogenoalkylsulfanyl comprising up to 9 halogen atoms which can be the same or different ; substituted or non substituted C<sub>2</sub>-C<sub>8</sub>-alkenyl ; C<sub>2</sub>-C<sub>8</sub>- halogenoalkenyl comprising up to 9 halogen atoms which can be the same or different ; substituted or non substituted C<sub>2</sub>-C<sub>8</sub>-alkynyl ; C<sub>2</sub>-C<sub>8</sub>-halogenoalkynyl comprising up to 9 halogen atoms which can be the same or different ; substituted or non substituted C<sub>2</sub>-C<sub>8</sub>-alkenyloxy ; C<sub>2</sub>-C<sub>8</sub>-halogenoalkenyloxy comprising up to 9 halogen atoms which can be the same or different ; substituted or non substituted C<sub>2</sub>-C<sub>8</sub>-alkynyloxy ; C<sub>2</sub>-C<sub>8</sub>-halogenoalkynyloxy comprising up to 9 halogen atoms which can be the same or different ; substituted or non substituted C<sub>3</sub>-C<sub>7</sub>-cycloalkyl ; C<sub>3</sub>-C<sub>7</sub>-halogenocycloalkyl comprising up to 9 halogen atoms which can

be the same or different ; substituted or non substituted C<sub>3</sub>-C<sub>7</sub>-cycloalkyl-C<sub>1</sub>-C<sub>8</sub>-alkyl ; substituted or non substituted C<sub>3</sub>-C<sub>7</sub>-cycloalkyl-C<sub>2</sub>-C<sub>8</sub>- alkenyl ; substituted or non substituted C<sub>3</sub>-C<sub>7</sub>-cycloalkyl-C<sub>2</sub>-C<sub>8</sub>-alkynyl ; substituted or non substituted C<sub>3</sub>-C<sub>7</sub>-cycloalkyl-C<sub>3</sub>-C<sub>7</sub>-cycloalkyl ; substituted or non substituted C<sub>1</sub>-C<sub>8</sub>-alkyl C<sub>3</sub>-C<sub>7</sub>-cycloalkyl ; formyl ; formyloxy ; formylamino ; carboxy ; carbamoyl ; N-hydroxycarbamoyl ; carbamate ; (hydroxyimino)-C<sub>1</sub>-C<sub>8</sub>-alkyl ; substituted or non substituted C<sub>1</sub>-C<sub>8</sub>-alkylcarbonyl ; C<sub>1</sub>-C<sub>8</sub>-halogenoalkylcarbonyl comprising up to 9 halogen atoms which can be the same or different ; substituted or non substituted C<sub>1</sub>-C<sub>8</sub>- alkylcarbamoyl ; substituted or non substituted di-C<sub>1</sub>-C<sub>8</sub>-alkylcarbamoyl ; N-(substituted or non substituted C<sub>1</sub>-C<sub>8</sub>-alkyloxy) carbamoyl ; substituted or non substituted C<sub>1</sub>-C<sub>8</sub>- alkoxycarbamoyl ; N-(substituted or non substituted C<sub>1</sub>-C<sub>8</sub>-alkyl)-(substituted or non substituted C<sub>1</sub>-C<sub>8</sub>-alkoxy)-carbamoyl ; substituted or non substituted C<sub>1</sub>-C<sub>8</sub>-alkoxy-carbonyl ; C<sub>1</sub>-C<sub>8</sub>-halogenoalkoxy-carbonyl comprising up to 9 halogen atoms which can be the same or different ; substituted or non substituted C<sub>1</sub>-C<sub>8</sub>-alkylaminocarbonyl; di- substituted or non substituted C<sub>1</sub>-C<sub>8</sub>-alkylaminocarbonyl ; substituted or non substituted C<sub>1</sub>-C<sub>8</sub>- alkylcarbonyloxy ; C<sub>1</sub>-C<sub>8</sub>-halogenoalkylcarbonyloxy comprising up to 9 halogen atoms which can be the same or different ; substituted or non substituted C<sub>1</sub>-C<sub>8</sub>- alkylcarbonylamino ; C<sub>1</sub>-C<sub>8</sub>-halogenoalkylcarbonylamino comprising up to 9 halogen atoms which can be the same or different ; substituted or non substituted C<sub>1</sub>-C<sub>8</sub>-alkylaminocarbonyloxy ; substituted or non substituted di-C<sub>1</sub>-C<sub>8</sub>-alkylaminocarbonyloxy; substituted or non substituted C<sub>1</sub>-C<sub>8</sub>-alkyloxy-carbonyloxy ; substituted or non substituted C<sub>1</sub>-C<sub>8</sub>-alkylsulfinyl ; C<sub>1</sub>-C<sub>8</sub>-halogenoalkyl-sulfinyl comprising up to 9 halogen atoms which can be the same or different ; substituted or non substituted C<sub>1</sub>-C<sub>8</sub>-alkylsulfonyl ; C<sub>1</sub>-C<sub>8</sub>-halogenoalkylsulfonyl comprising up to 9 halogen atoms which can be the same or different ; substituted or non substituted C<sub>1</sub>-C<sub>8</sub>-alkoxyimino ; (C<sub>1</sub>-C<sub>8</sub>-alkoxyimino)-C<sub>1</sub>-C<sub>8</sub>-alkyl ; substituted or non substituted (C<sub>1</sub>-C<sub>8</sub>-alkenyloxyimino)-C<sub>1</sub>-C<sub>8</sub>-alkyl ; (C<sub>1</sub>-C<sub>8</sub>-alkynyloxyimino)-C<sub>1</sub>-C<sub>8</sub>-alkyl ; a (benzyloxyimino)-C<sub>1</sub>-C<sub>8</sub>-alkyl ; tri(substituted or non substituted C<sub>1</sub>-C<sub>8</sub>-alkyl)silyl ; tri(substituted or non substituted C<sub>1</sub>-C<sub>8</sub>-alkyl)silyl-C<sub>1</sub>-C<sub>8</sub>-alkyl ; benzyloxy which can be substituted by up to 5 groups Q; benzylsulfanyl which can be substituted by up to 5 groups Q; benzylamino which can be substituted by up to 5 groups Q; aryl which can be substituted by up to 7 groups Q; aryloxy which can be substituted by



up to 7 groups Q ; arylamino which can be substituted by up to 7 groups Q ; arylsulfanyl which can be substituted by up to 7 groups Q ; aryl-C<sub>1</sub>-C<sub>8</sub>alkyl which can be substituted by up to 7 groups Q ; aryl-C<sub>2</sub>-C<sub>8</sub>-alkenyl which can be substituted by up to 7 groups Q ; aryl-C<sub>2</sub>-C<sub>8</sub>-alkynyl which can be substituted by up to 7 groups Q ; pyridinyl which can be substituted by up to 4 groups Q ; pyridinyloxy which can be substituted by up to 4 groups Q ; aryl-C<sub>3</sub>-C<sub>7</sub>-cycloalkyl which can be substituted by up to 7 groups Q ; or

Two vicinal substituents R together with the consecutive carbon atoms to which they are linked form a substituted or non substituted 5- or 6-membered, saturated, carbo- or hetero-cycle comprising up to 3 heteroatoms and the other substituents R are as herein- described; or

• R<sup>1</sup> and Z<sup>3</sup> together with the consecutive carbon atoms to which they are linked form a substituted or non substituted 5-, 6- or 7-membered, partly saturated, carbo- or hetero-cycle comprising up to 3 heteroatoms, and R<sup>2</sup> to R<sup>5</sup> are as herein-described.

110/2019 BAYER CROPSOURCE AG, Germany.—“N-BENZYL-N-CYCLOPROPYL-3-(DIHALO-METHYL)-5-HALO-1-METHYL-PYRAZOLE-4-CARBOXAMIDE COMPOUND”.

C07D231/16.

143529

The present invention relates to a compound of formula (IIf)

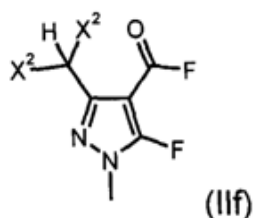

wherein X<sup>2</sup> represents a chlorine or a fluorine atom, preferably a fluorine atom.

111/2019 BAYER CROPSOURCE AG, Germany.—“N-BENZYL-N-CYCLOPROPYL-3-(DIHALO-METHYL)-5-HALO-1-METHYL-PYRAZOLE-4-CARBOXAMIDE COMPOUND”.

C07D231/16.

143530

The present invention relates to a compound of formula (IIb)

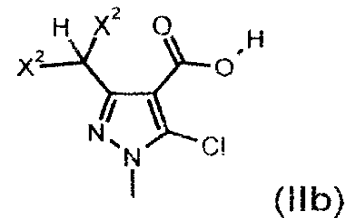

wherein X<sup>2</sup> represents a chlorine or a fluorine atom, preferably a fluorine atom.

112/2019 BAYER CROPSOURCE AG, Germany.—“N-BENZYL-N-CYCLOPROPYL-3-(DIHALO-METHYL)-5-HALO-1-METHYL-PYRAZOLE-4-CARBOXAMIDE COMPOUND”.

C07D231/16 & C07D231/16.

143531

The present invention relates to a compound of formula (IIc')

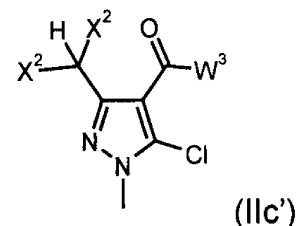

wherein X<sup>2</sup> represents a chlorine or a fluorine atom, preferably a fluorine atom; and W<sup>3</sup> represent a halogen atom, preferably a chlorine atom.

113/2019 BAYER CROPSOURCE AG, Germany.—“N-BENZYL-N-CYCLOPROPYL-3-(DIHALO-METHYL)-5-HALO-1-METHYL-PYRAZOLE-4-CARBOXAMIDE COMPOUND”.

C07D231/16.

143532

The present invention relates to a compound of formula (II d)

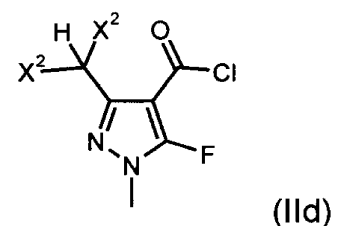

wherein X<sup>2</sup> represents a chlorine or a fluorine atom, preferably a fluorine atom.

194/2019 VIIV HEALTHCARE UK (No.5) LIMITED, United Kingdom.—“A pharmaceutically acceptable salt of C-3 and C-17 Modified triterpenoids as HIV-I Inhibitor”

C07J63/00, C12N9/50, A61K31/575, A61K31/56, A 61K 31/58 & A61P 31/18.

143533 287/2019

The present invention provides a pharmaceutically acceptable salt of a compound wherein said salt is the salt of formula 1:

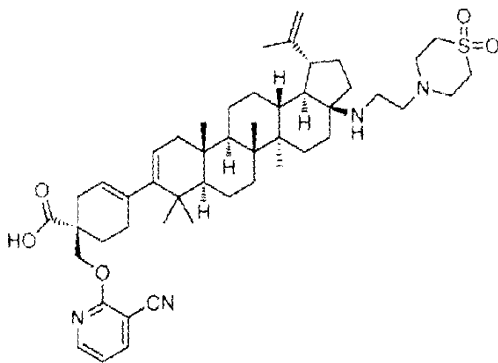

The pharmaceutically acceptable salt of a compound having drug and bio-affecting properties, its pharmaceutical composition thereof. In particular, salt of betulinic acid possess unique antiviral activity are provided as HIV maturation inhibitors and are useful for the treatment of HIV and AIDS.

CASALE SA., Switzerland.—“A PROCESS FOR NITRIC ACID PRODUCTION”.

C01B21/26, C01B21/28 & C01C1/04.

143534

Integrated process for the synthesis of ammonia and nitric acid including: a) production of an ammonia make-up synthesis gas, comprising steam reforming of a hydrocarbon feedstock under provision of steam reforming heat; catalytic conversion of said make-up synthesis gas into ammonia; catalytic oxidation of a stream of ammonia obtaining a process gas; absorption of said process gas with water obtaining nitric acid, wherein at least a portion of the steam reforming heat is recovered from said hot process gas.

#### **NEW APPLICATIONS FOR THE INDUSTRIAL DESIGNS**

S. No.	Design No.	Title & Class	Applicant
<b>15th June, 2020</b>			
1.	20418	Textile Articles, Dresses & Clothes (Class-13)	Maria B Designs Private Limited
2.	20419	Textile Articles, Dresses & Clothes (Class-13)	Maria B Designs Private Limited
3.	20420	Textile Articles, Dresses & Clothes (Class-13)	Maria B Designs Private Limited
4.	20421	Textile Articles, Dresses & Clothes (Class-13)	Maria B Designs Private Limited
5.	20422	Textile Articles, Dresses & Clothes (Class-13)	Maria B Designs Private Limited
6.	20423	Textile Articles, Dresses & Clothes (Class-13)	Maria B Designs Private Limited
7.	20424	Textile Articles, Dresses & Clothes (Class-13)	Maria B Designs Private Limited
8.	20425	Textile Articles, Dresses & Clothes (Class-13)	Maria B Designs Private Limited
9.	20426	Textile Articles, Dresses & Clothes (Class-13)	Maria B Designs Private Limited
10.	20427	Textile Articles, Dresses & Clothes (Class-13)	Maria B Designs Private Limited
11.	20428	Textile Articles, Dresses & Clothes (Class-13)	Maria B Designs Private Limited
12.	20429	Textile Articles, Dresses & Clothes (Class-13)	Maria B Designs Private Limited

S. No.	Design No.	Title & Class	Applicant
<b>16th June, 2020</b>			
13.	20430	Beverage cup with removable lid (Class-03)	Batsam Group S.a.r.l.
<b>18th June, 2020</b>			
14.	20431	AUTOMOBILE (CLASS-01)	TOYOTA JIDOSHA KABUSHIKI KAISHA
15.	20432	AUTOMOBILE (CLASS-01)	TOYOTA JIDOSHA KABUSHIKI KAISHA

### REGISTRATION OF DESIGNS

The following designs have been registered.

S. No.	Design No.	Title & Class	Applicant
<b>15th June, 2020</b>			
1.	20039	Tyre (Class-03)	Jianxin Tyre (Fujian) Co., Ltd.
2.	20092	Football (Class-06)	Madrigal Sports (Pvt) Ltd.
3.	20041	Dispenser (Class-12)	Unilever PLC
4.	20087	Brain Imaging Tool for Medical Diagonosis (Class-03)	Muhammad Hamza Asif Nizami, Umer Asgher, Sara Ali, Yasar Ayaz and Muhammad Jawad Khan
5.	19998	Mobile Phone (Class-03)	M/s. FOXXCOM (Pvt.) LIMITED
6.	19997	Pet Bottle (Class-03)	M/s. Shangrila (Private) Limited
7.	19996	Mobile Phone (Class-03)	M/s. FOXXCOM (Pvt.) LIMITED
8.	19461	Instrument Panel for an Automobile (Class-01)	Toyota Jidosha Kabushiki Kaisha
9.	19841	Brooch (Jewelry) (Class-01)	MACON & LESQUOY
10.	20097	Automobile (Class-01)	Toyota Jidosha Kabushiki Kaisha
11.	20055	Radiator Grill for an Automobile (Class-01)	Hino Motors, Ltd.

<b>S. No.</b>	<b>Design No.</b>	<b>Title &amp; Class</b>	<b>Applicant</b>
12.	20040	Compressor Unit (Class-03)	Maschinenfabrik Rieter AG
13.	20044	Moccasin (Footwear)	Dil Bahar Plastic Industry
14.	20103	Smart Payment Notification Device (Class-12)	Alibaba Group Holding Limited
15.	20091	Football (Class-06)	Madrigal Sports (Pvt) Ltd.
16.	20000	Battery for Electric Power Unit (Class-03)	Honda Motor Co., Ltd.
17.	20003	Battery Module for Electric Power Unit (Class-03)	Honda Motor Co., Ltd.
18.	19634	Machine (Class-01)	CDE Asia Limited
19.	19999	Electric Power Unit (Class-03)	Honda Motor Co., Ltd.
20.	19927	A Motorcycle (Class-01)	Honda Motor Co., Ltd.
21.	20001	Electric Power Unit (Class-03)	Honda Motor Co., Ltd.

DR. MUHAMMAD FAYYAZ AHMAD,  
Controller of Patents & Registrar of Designs.