

# The Gazette of Pakistan

PUBLISHED BY AUTHORITY

No. 41]

KARACHI, WEDNESDAY, OCTOBER 7, 2020

## C O N T E N T S

PAGES	PAGES
<b>PART I</b> — Notifications regarding appointments, promotions, etc., issued by Ministries/Divisions of the Government of Pakistan, Department of the Auditor-General of Pakistan and the Supreme Court of Pakistan other than the Ministry of Defence and Ministry of Defence Production .....	<b>PART IV</b> — Notifications issued by the minor administrations and miscellaneous notification not included in any other part .....
1147—1189	69—72
<b>PART II</b> — Notifications issued by the Ministry of Defence and Ministry of Defence Production	<b>PART V</b> — Notifications etc., issued by The Patent Office.
541—548	87—94
<b>PART III</b> — Notifications issued by the High Courts, the Federal Public Service Commission and by the Attached and Subordinate Offices of the Government of Pakistan .....	<b>PART VI</b> — Advertisements and Notices issued by Corporate Bodies and Private Individuals on payment .....
809—825	169—176
	<b>SUPPLEMENT NO.</b>
	Weekly, notification of cases and deaths from quarantiable diseases .....

## PART I

**Notifications regarding appointments, promotions, etc. issued by Ministries/Divisions of the Government of Pakistan, Department of the Auditor-General of Pakistan and the Supreme Court of Pakistan other than the Ministry of Defence and Ministry of Defence Production**

PRIME MINISTER'S OFFICE (PUBLIC)

[BOARD OF INVESTMENT]

Islamabad, the 14th September, 2020

Islamabad, the 11th September, 2020

**No. F.6(7)-Estt/80.**—On attaining the age of superannuation Mr. Muhammad Zafar Iqbal, Senior Private Secretary (BS-19) of Prime Minister's Office (Public), shall stand retired from Government Service on 31st December, 2020.

**No. F.5(13)/2009-Admn.**—On the recommendation of Departmental Promotion Committee and with the approval of competent authority, Ms. Gul Afshan, Assistant Private Secretary (BS-16) of this office is promoted to the post of Private Secretary (BS-17) with immediate effect. She will be on probation in terms of Rule 21 of Civil Servants (Appointment, Promotion & Transfer), Rules, 1973.

HAIDER MUNAWAR CHEEMA,  
Section Officer (Admn).

**No. 1(109)2020-SEZ.**—Pursuant to the in principle approval made by the 5th Meeting of Board of Approvals under Section 3 (n) read with Section 6 (b) of the Special Economic Zones Act, 2012 (XX of 2012), and in exercise of powers conferred upon Approvals Committee under Section 7 (3) of the above said Act, the Committee in its 7th meeting dated 13th August, 2020 is pleased to approve the following zone application received from the SEZA Punjab and to grant the status and notify it, as Special Economic Zone as per below given detail:-

Sr. No.	Name	Type	Location	Total Area (Acres)
1.	Allama Iqbal Industrial City	Public	Sahianwala Interchange, Faisalabad	2,800

(1147)

2. This notification is subject to the following conditions; and violation of any or all of these conditions, partly or wholly, shall lead to withdrawal/ revocation of the notification of the respective SEZ with immediate effect:-

- i. Construction of the Zone shall commence within 6 months from the date of this notification and each Developer will share with respective SEZA and the Secretariat of Approvals Committee/BOA the development progress of its respective Zone as per the submitted Master Plan and Execution Plan developed in Primavera/MS Project, on quarterly basis;
- ii. No change shall be made in the contents of the approved zone application without prior approval of BOA;
- iii. Development and operations of the Zone shall be as per Master Plan submitted with the approved zone application;
- iv. Till the approval of the Development Agreement and/or constitution of the SEZ Committees, no Zone Developer will be entitled to sell/lease any Industrial/Commercial plot or sign or intend to sign and MOU or agreement or any such instrument conditionally or unconditionally to sell/lease any such plot to any investor/enterprise or any other party;
- v. Zone Enterprises shall only be admitted into the Zone, after the approval of the respective SEZ Committee as provided under Section 23 of the SEZ Act 2012;
- vi. At the time of consideration of a Zone Enterprise entry application by the SEZ Committee, the respective Developer shall undertake to ensure provision of utilities to that Zone Enterprise, if admitted in the SEZ, as per the requirement and timeframe stated in its Zone Enterprise entry application.
- vii. Zone Developer shall at all time keep a clear title of the land or leasehold rights, that should be free from all encumbrances;
- viii. Zone Developers shall unconditionally comply with all the instructions/ regulations/SOPs/Circulars/ clarifications etc., issued by the respective Provincial SEZA, Federal Board of Investment (BOI), being Secretariat of the Approvals Committee and BOA, as and when required to advance the objective of the SEZ Act, 2012;
- ix. The cost of utilities if any, for the private zones, till zero point, shall be borne by the respective Zone Developers;
- x. All conditions mentioned in the EPA certificate provided with the zone application or other requirements mentioned from time to time by the respective Environmental Protection Agency will be adhered by the Zone Developer in letter and spirit;
- xi. The Federal BOI, being Secretariat of the Approvals Committee and BOA, or respective SEZA may, at any time, by notice in writing require any director, officer and member of the Developer or respective Zone Enterprise, in general or in particular to furnish bi-annual reports containing any information relating to their project within the time specified therein or such further time as the BOI or respective SEZA may allow, with any statement or information and without prejudice to the generality of the foregoing power, may call for information, at such intervals as the Federal BOI or respective SEZA may deem necessary;
- xii. Quantum of processing fee, if any for zone enterprises entry applications shall be charged from prospective Zone Enterprises only after approval from the BOA;
- xiii. Developers and enterprises housed in the zone after the date of Notification of SEZ, regardless of claiming and expiry of incentives available under the SEZ Act 2012, shall be bound to adhere all the provisions of the above said Act, SEZ Rules 2013 and any amendments made thereof and/or rules, regulations, clarifications, directives etc. issued by the SEZ Secretariat from time to time; and,
- xiv. Processing or other fee, if any, levied by Federal BOI with the approval of BOA shall be payable with immediate effect by the respective Developer under Rule-62 (1)(b) of SEZ Rules, 2013.

3. Unless otherwise provided in the SEZ Act, 2012, SEZ Rules 2013 or any amendments made thereof and/or rules, regulations, clarifications, directives etc. issued thereunder or specifically approved by the BOA as empowered under Section 6(a) and 6(j) of the SEZ Act, 2012, this approval/notification does not absolve the Zone Developer and/or any of its zone enterprise from the responsibility of taking any other certification/permit/license or any other instrument and/or from complying with any other statutory requirements as provided under any applicable statute, law ordinance, notification, rule, regulation, judgment, order, decree, by-law, approval, directive, guideline, policy, requirement, whether in effect as of the date of this notification or thereafter.

FAREENA MAZHAR,  
Secretary BOI/BOA.

NATIONAL ACCOUNTABILITY BUREAU

Islamabad, the 14th September, 2020

**No. 3(1714)/K/2016-PM-III.**—In pursuance of this Bureau's notification of even number dated 13th August, 2020,

Mirza Saqib Baig relinquished the charge of the post of Deputy Director (BS-18), National Accountability Bureau (HQ) Islamabad with effect from 13th August, 2020 and assumed the charge of the post of Deputy Director (BS-18) National Accountability Bureau (Balochistan) Quetta with effect from 25th August, 2020.

MUHAMMAD SHOAB,  
Deputy Director (PM-I).

Islamabad, the 11th September, 2020

**No. 1(538)/Admn/2013/1620.**—Director General NAB (R)/Islamabad has been pleased to grant 9 days leave on full pay (LFP) with effect from 14th September, 2020 to 22nd September, 2020 in respect of Mr. Azmat Ullah, Assistant Director (BPS-17), NAB (R), Sub office Gilgit.

On the expiry of leave, the officer will resume his duties of the same post at the same station.

MUHAMMAD QASIM,  
Assistant Director (Admn).

CABINET SECRETARIAT

(Cabinet Division)

Islamabad, the 7th September, 2020

**No. PF(1014)-Admn-II.**—With the approval of competent authority *i.e.* Special Secretary, Sardar Mehmood, Section Officer (Admn-II) (BS-18) is assigned to hold additional charge of the post of Section Officer (IT), Cabinet Division with immediate effect, in addition to his own duties for a period of three (03) months or till posting of a regular officer whichever is earlier.

MUHAMMAD ZAHID SHAH,  
Deputy Secretary (Admn).

Islamabad, the 7th September, 2020

**No. PF(1014)-Admn-II.**—In pursuance of Establishment Division's Notification No. PF.1030/2011-E-VII dated 28th August, 2020 Syed Iftikhar Ahmed, Section Officer (OMG/BS-18) has relinquished the charge of the post of Section Officer (BS-18), Cabinet Division on 7th September, 2020.

SARDAR MEHMOOD,  
Section Officer (Admn-II).

Islamabad, the 4th September, 2020

**No. F. 10-31/2016-Org-III.**—In exercise of powers conferred by section 112 of Memorandum and Articles of

Association of Pakistan Tourism Development Corporation (PTDC) read with section 187 (4) of the Companies Act, 2017, and with the approval of the Federal Cabinet, current charge of the post of Managing Director, PTDC has been entrusted to Mr. Intikhab Alam, General Manager, PTDC with immediate effect, for a period of (03) months or till appointment of a regular incumbent, whichever is earlier.

Islamabad, the 10th September, 2020

**No. 10-31/2016-Org-III.**—In pursuance of the Cabinet Division's notification of even number dated 4th September, 2020, Syed Intikhab Alam, General Manager, Pakistan Tourism Development Corporation (PTDC), has assumed charge of the post of Managing Director (PTDC), on 4th September, 2020 on current charge basis for a period of (03) months or till appointment of a regular incumbent, whichever is earlier.

SYED ZAKI HASSAN NAQVI,  
Section Officer (Org-III).

(Establishment Division)

Islamabad, the 11th August, 2020

**No. PF(593)/E-5(PAS).**—The President has been pleased to assign additional charge of the post of Chairman, Pakistan Science Foundation, to Capt. (Retd.) Nasim Nawaz (PAS/BS-22), Secretary, Science and Technology Division, with effect from 17th June, 2020, for a period of three months, or till the posting of regular Chairman, Pakistan Science Foundation, whichever is earlier.

**No. PF(684)/E-5(PAS).**—Mr. Waseem Ajmal Chaudhry, a BS-20 officer of Pakistan Administrative Service, presently posted as OSD, Establishment Division, is transferred and posted as Joint Secretary, Federal Education and Professional Training Division, with immediate effect and until further orders.

**No. 1/193/2017-E-4.**—The competent authority has been pleased to approve extension in deputation of Mr. Safer Ahmed, a BS-19 officer of Pakistan Audit and Accounts Service, in Government of Khyber Pakhtunkhwa, for further period of two years with effect from 18th August, 2020 or till promotion of suitable person against the said position, whichever is earlier, on standard terms and conditions and until further orders.

**No. PF(1217)/E-5(PAS).**—Mr. Zahid Pervez, a BS-18 officer of Pakistan Administrative Service, presently awaiting posting in Establishment Division, is transferred and his services are placed at the disposal of Government of the Punjab, with immediate effect and until further orders.

**No. F.12(47)/2012-E-3(Police).**—The Extra Ordinary Leave (EOL) (*ex-Pakistan*) (without pay) of Syed Zubair Shah, a BS-18 officer of Police Service of Pakistan, is

extended for a further period of three (03) months with effect from 1st July, 2020 to 30th September, 2020.

**No. PF(906)/E-5(PAS).**—In partial modification of para 2 of this Division's notification of even number dated 3rd August, 2020, this Division's notification of even number dated 8th July, 2020 is hereby cancelled/withdrawn *ab-initio*.

**No. PF(1429)/E-5(PAS).**—Mr. Shaheryar Qamar, a BS-17 officer of Pakistan Administrative Service, presently posted under Government of Sindh, is transferred and his services are placed at the disposal of Railways Division, on deputation basis, for a period of three years, on standard terms and conditions, with immediate effect and until further orders.

**No. 1/47/2020-E-6.**—The competent authority has been pleased to appoint Mr. Muhammad Obaid Mustafa as Nautical Surveyor, MP-III Scale, Ports & Shipping Wing, Karachi under Ministry of Maritime Affairs on contract basis for a period of two (02) years with immediate effect and until further orders.

Islamabad, the 12th August, 2020

**No. 4/2/2013-E-4.**—With the approval of the competent authority, Air Commandore Asif Shahzad Pakistan Air Force, is transferred and posted as OSD-II (BS-20) in Ministry of Defence Production, on secondment basis, upto 27th August, 2022 *i.e.* tenure of Air Force, or till his date of retirement.

Islamabad, the 13th August, 2020

**No. 1/140/2020-E-4.**—Mr. Hyder Ali Sundrani, Joint Secretary (BS-20), Senate Secretariat, Islamabad is transferred and his services are placed at the disposal of Government of the Punjab on deputation basis, for a period of three years, on standard terms and conditions, with immediate effect and until further orders.

Islamabad, the 20th August, 2020

**No. 4/60/2019-E-4.**—The competent authority has been pleased to appoint Air Vice Marshal Irfan Zaheer (Pak/10031) Engineer Officer as Director Precision Engineering Complex (PEC), PIACL under Aviation Division on secondment basis for a period of three (03) years or till the completion of transfer of ownership of PEC from PIACL to PAF, whichever is earlier, on standard terms and conditions as contained JSI 4/85, with immediate effect and until further orders.

MARIAM KAYANI,  
Deputy Secretary.

Islamabad, the 6th August, 2020

**No. F.3/1/2017-T-IV.**—Mr. Nadeem Siddiqui, Deputy Director (BS-18) Secretariat Training Institute, Islamabad,

shall stand retired from Government Service, on attaining the age of superannuation, with effect from 11th July, 2021.

This issues with the approval of the Secretary, Establishment Division, Islamabad.

SEEMI A. KHAN,  
Deputy Secretary.

Islamabad, the 6th August, 2020

**No. 1/131/2020-E-4.**—Mr. Mahmood Amir (PA&AS/BS-20) is transferred and his services are placed at the disposal of Government of Balochistan for further posting as Treasurer in Sardar Bahadur Khan Women's University (SBKWU), on deputation basis, for a period of three years, on standard terms and conditions, with immediate effect and until further orders.

**No. PF.4/115/2012-E-VII.**—Mr. Intikhab Ahmad (BS-18/Deputationist), Section Officer, Overseas Pakistanis and Human Resource Development Division is repatriated to his parent department *i.e.* Higher Education Department, Government of the Punjab, with immediate effect.

**No. PF.1268/2014-E-VII.**—Mr. Muhammad Kamran (OMG/BS-18), presently posted as Section Officer, Law and Justice Division is transferred and posted as Section Officer, Housing and Works Division, with immediate effect and until further orders.

**No. PF.878/2008-E-VII.**—The deputation period of Mr. Muhammad Farooq (OMG/BS-18), presently at the disposal of Ministry of Foreign Affairs is extended for a period of two years with effect from 29th November, 2019 to 28th November, 2021. The officer shall be repatriated to Establishment Division upon completion of extended period of deputation.

Islamabad, the 7th August, 2020

**No. 1/196/2019-E-4.**—Mr. Khadim Hussain Mirani (PA&AS/BS-18), Director Audit Petroleum and Natural Resources, Karachi is transferred and his services are placed at the disposal of Cabinet Division for further posting as General Manager (Finance and Admin), Sindh, Infrastructure Development Company Limited, Karachi, on deputation basis, for a period of three years, on standard terms and conditions, with immediate effect and until further orders.

Islamabad, the 10th August, 2020

**No. PF.1073/2011-E-VII.**—Mr. Iftikhar Ahmed Khan (OMG/BS-18), awaiting posting, Establishment Division is transferred and posted as Section Officer, Management

Services Wing (PPARC), Establishment Division, as a replacement of Mr. Javed Shah, with immediate effect and until further orders.

**No. PF.943/2009-E-VII.**—Ms. Saima Bibi (OMG/BS-18), OSD, Establishment Division is transferred and posted as Section Officer, Maritime Affairs Division, with immediate effect and until further orders.

**No. PF.1053/2011-E-VII.**—Mr. Zahid Nazir (OMG/BS-18) Section Officer, Overseas Pakistanis and Human Resource Division is transferred and posted as Section Officer, National Security Division, with immediate effect and until further orders.

**No. PF.1044/2011-E-VII.**—Mr. Shahzad Zareef (OMG/BS-18), Section Officer, Finance Division, is transferred and his services are placed at the disposal of Ministry of Railways (Railway Board), on standard terms and conditions of deputation, for a period of three years, with immediate effect and until further orders.

**No. PF.1073/2011-E-VII.**—Mr. Javed Shah (OMG/BS-18) Section Officer, Management Services Wing (PPARC), Establishment Division is transferred and posted as Section Officer, Climate Change Division, with immediate effect and until further orders.

**No. PF.987/2011-E-VII.**—Malik Ishfaq Khan (OMG/BS-18) Section Officer, Finance Division is transferred and posted as Section Officer, Narcotics Control Division, with immediate effect and further orders.

Islamabad, the 11th August, 2020

**No. PF.973/2011-E-VII.**—Hafiz Ubaidullah Zakria (OMG/BS-18), awaiting posting in Establishment Division is transferred and posted as OSD, Establishment Division with effect from 6th August, 2020.

Hafiz Ubaidullah Zakria is granted 40 days leave on full pay, subject to title, with effect from 6th August, 2020. The officer shall report to Establishment Division after the leave period.

**No. PF.1049/2011-E-VII.**—Mr. Muhammad Amin (OMG/BS-18), presently at the disposal of Federal Board of Revenue, is repatriated and directed to report to Establishment Division, with immediate effect and until further orders.

**No. F.1195/2013-E-VII.**—Ms. Amna Shuja (OMG/BS-18), OSD, Establishment Division, is transferred and posted as Section Officer, Establishment Division for further posting in Regulation Wing, with immediate effect and until further orders.

**No. PF.922/2009-E-VII.**—Ms. Affaf Faiz Rasool Malik (OMG/BS-18), presently at the disposal of National Disaster Management Authority (NDMA), is repatriated and directed to report to Establishment Division, with immediate effect and until further orders.

Islamabad, the 12th August, 2020

**No. PF.1273/2014-E-VII.**—Mr. Misbah-ur-Rehman, (OMG/BS-18), Section Officer, Finance Division (Military), is transferred and his services are placed at the disposal of Azad Jammu and Kashmir Council Secretariat, on standard terms and conditions of deputation, for a period of three years, with immediate effect and until further orders.

**No. PF.4/22/2017-E-VII.**—Ms. Lubna Shahzaman (BS-17/Deputationist), Section Officer, Interior Division is repatriated to her parent department *i.e.* Establishment Department, Government of Khyber Pakhtunkhwa, with immediate effect.

**No. PF.4/40/2011-E-VII.**—Mr. Muhammad Arslan Zahid, Research Officer (BS-17), National Food Security and Research Division, presently posted as Section Officer, National Food Security and Research Division, on deputation basis, is transferred and posted as Section Officer, Prime Minister's Office (Public), under Section-10 of Civil Servants Act, 1973, with immediate effect and until further orders.

Islamabad, the 18th August, 2020

**No. PF.980/2011-E-VII.**—Mr. Qaiser Farooq (OMG/BS-18), OSD, Establishment Division is transferred and posted as Section Officer, Petroleum Division, as a replacement of Mr. Waqas Ali Khan, with immediate effect and until further orders.

**No. PF.1277/2014-E-VII.**—Mr. Muhammad Asif Riaz (OMG/BS-18), presently posted as Section Officer, Commerce Division (Textile Wing) is transferred and posted as Section Officer, Religious Affairs and Inter-Faith Harmony Division, with immediate effect and until further orders.

**No. PF.1202/2013-E-VII.**—Ms. Farwa Abbas (OMG/BS-18), OSD, Establishment Division is transferred and her services are placed at the disposal of Benazir Income Support Programme (BISP), on standard terms and conditions of deputation, for a period of three years, with effect from 28th August, 2020.

SHAMS-UD-DIN,  
Section Officer.

Islamabad, the 10th August, 2020

**No. F.2/1/2018-Admn-II(NCGR).**—Mr. Muhammad Shafique, Assistant Director (BS-17), (an employee of NCGR Defunct) working in Establishment Division (Main) against supernumerary post is granted encashment for 365

days in lieu of 365 days Leave Preparatory to Retirement (LPR) from 9th March, 2020 to 8th March, 2021.

On attaining the age of superannuation and on expiry of encashment of LPR, the officer shall stand retired from Government Service with effect from 8th March, 2021.

MUHAMMAD NADEEM MUJAHID,  
Section Officer (Admn-II).

Islamabad, the 17th August, 2020

**No. PF.(776)/E-5(PAS).**—The Federal Government has been pleased to extend additional charge of the post of Chairman, Capital Development Authority, Islamabad, granted to Mr. Amer Ali Ahmad (PAS/BS-20), Chief Commissioner, ICT, under Interior Division, for a further period of three months with effect from 15th July, 2020 for the last time and direct the CDA to complete the process of filling the post on whole time basis, in terms of Section 6 (1) and (3) of the CDA Ordinance, 1960.

ASMA SANALLAH,  
Section Officer.

Islamabad, the 18th August, 2020

**No. 1/225/2016-E-4.**—The competent authority has been pleased to approve extension in deputation of Mrs. Gulshan Amna, Lecturer in Mathematics (BS-17), Higher Education, Archives & Libraries Department, Government of Khyber Pakhtunkhwa in FGEI (C/G) set up under Ministry of Defence for further period till 18th August, 2020 on standard terms and conditions under wedlock policy.

The officer stands repatriated to her parent department (*i.e.* Higher Education Archives & Libraries Department of Khyber Pakhtunkhwa) with immediate effect.

FALAK SHER,  
Section Officer.

Islamabad, the 6th August, 2020

**No. 1/13/2019-D-I.**—Consequent upon his release on bail by H'able Lahore High Court, Lahore *vide* Judgement dated 15th January, 2020, Mr. Muhammad Usman Anwar (PAS/BS-20) placed under suspension under CSR, 194, *vide* Services & General Administration, Government of the Punjab, Lahore's Notification No. SO(C-III)3-36/2019, dated 22nd October, 2019 is re-instated into service with effect from 15th January, 2020.

KAUSAR ALI KHAN,  
Section Officer.

Islamabad, the 20th August, 2020

OBITUARY

**No. F.1(47)/2011-RB.**—The Government of Pakistan announces with regret the sad demise of Mr. Muhammad Younis, Project Director (BS-17) of Establishment Division, Islamabad on 6th July, 2020.

The Government of Pakistan wishes to place on record its appreciation for services rendered by him with devotion and dedication. In recording its deep sense of grief on his sudden death, the Government of Pakistan conveys its condolence and deep sympathy to the members of the bereaved family.

ABDUR REHMAN,  
Section Officer (RB).

(Pakistan Public Administration Research Centre)

Islamabad, the 19th August, 2020

**No. 1/17/2019-PPARC.**—In pursuance of Establishment Division's Notification No. PF.1073/2011-E-VII, dated 10th August, 2020, Mr. Javed Shah, a BS-18 officer of Office Management Group (OMG) has relinquished the charge of the post of Section Officer (Admn) (BS-18) in Pakistan Public Administration Research Centre (PPARC), Establishment Division, Islamabad with effect from 11th August, 2020.

IFTIKHAR AHMED KHAN,  
Section Officer (Admn).

[BENAZIR INCOME SUPPORT PROGRAMME]

Islamabad, the 28th August, 2020

**No. 1(705)/BISP/HR/BAL/15.**—Mr. Sohail Anwar, Lecturer (BPS-18), Balochistan University of Information Technology, Engineering & Management Sciences, Quetta, presently posted as Deputy Director (Operations) (SPS-18), Regional Office, BISP Balochistan, shall stand repatriated to his parent department with effect from 31st August, 2020.

This issues with the approval of the Secretary, BISP.

Islamabad, the 31st August, 2020

**No. 1(766)/BISP/HR/2015.**—Ms. Uzma Umer, Senior Auditor (BPS-16) of Accountant General of Pakistan Revenue, Islamabad, presently posted as Assistant Accounts Officer, Divisional Office BISP Rawalpindi, on deputation basis, shall stand repatriated to her parent department with effect from 30th September, 2020.

This issues with the approval of Director General (Admin & HR), BISP.

**No. 1(1304)/BISP/HR/AJK/2018.**—Mr. Fazal-ur-Rehman, Senior Auditor (SPS-16), BISP Regional Office, Muzaffarabad AJ&K is hereby granted additional charge of the vacant post of Assistant Accounts Officer (SPS-16), BISP Divisional Office Muzaffarabad AJK, with immediate effect, in addition to his own duties, for a period of three (3) months or till appointment/posting of a regular incumbent of the post, whichever is earlier.

This issues with the approval of the Director General (Admin & HR) BISP.

MUHAMMAD AHMAD USMANI,  
Director HR (Regions).

---

WAFAQI MOHTASIB (OMBUDSMAN)'S SECRETARIAT

Islamabad, the 31st August, 2020

**No. F.1(1024)A-II/2019.**—In pursuance of this Secretariat's Office Order No. 3(62)A-II/2019 dated 29th July, 2020, Rana Asif Nazeer has assumed the charge of the post of Investigation Officer (BS-17) at WMS, Regional Office, Multan on 7th August, 2020.

This issues with the approval of competent authority.

MOINUDDIN A. SIDDIQI,  
Director (Admn).

---

MINISTRY OF COMMERCE

Islamabad, the 26th August, 2020

**No. 4(6)95/Admin-III/CTG.**—Consequent upon the Scrutiny of the official and personal records of Dr. Zia Ahmed, a BS-19 officer of Commerce & Trade Group presently posted as Deputy Chief, Ministry of Commerce the competent authority is pleased to exonerate the officer of any charge and/or disciplinary proceedings against him as per following details.

- i) The fact-finding inquiry proceedings against the officer in connection with financial misappropriation allegations during his posting as Commercial Secretary, Consulate General of Pakistan Houston (2007-2010) stand closed being baseless and frivolous.
- ii) Moreover, there is nothing pending against the officer in respect of any kinds of inquiry/disciplinary proceedings under Government Servants (Efficiency & Discipline) Rules, 1973 and/or any fact-finding proceedings from any quarter.

This issues with the approval of Secretary, Ministry of Commerce.

NOSHEEN IMTIAZ,  
Director (HR&CP).

Islamabad, the 26th August, 2020

**No. 2(177)TID/14-Admn.**—In pursuance of Establishment Division's Notification No. PF.1222/2013-E-VII, dated 4th August, 2020, consequent upon her transfer, Ms. Wajeeha Bashir, a BS-18 officer of Office Management Group, has relinquished the charge of the post of Section Officer, Ministry of Commerce, Islamabad, on 26th August, 2020, to join her new assignment as Section Officer, National Food Security and Research Division.

**No. 12(17)/81-Admn-I/MoC.**—Mr. Tahir Ali, Superintendent (BS-16), Ministry of Commerce, Islamabad, had been assigned current charge for the post of Section Officer, Trade Offices (TO-II), Ministry of Commerce, with effect from 29th May, 2020 to 18th August, 2020.

This issues with the approval of Secretary Commerce.

MUHAMMAD IMTIAZ,  
Deputy Director (MoC).

---

[TRADE DISPUTE RESOLUTION ORGANIZATION]

Islamabad, the 12th August, 2020

**No. 2(10)/2014-TDRO.**—A Purchase Committee has been constituted for Trade Dispute Resolution Organization (TDRO) comprising the following officers:-

- i) Director (TD), TDRO, Chairman
- ii) S.O. (Gen), Ministry of Commerce, Member
- iii) Deputy Director (TD), TDRO Member/Secretary

2. This issues with the approval of Director General, TDRO.

KAMRAN KHAN,  
Deputy Director (Ad/Fin).

---

MINISTRY OF COMMUNICATIONS

Islamabad, the 31st August, 2020

**No. 4(5)/2018-Roads-I.**—In pursuance of Establishment Division's Notification No. 1/139/2020-E-4 dated 24th August, 2020, Mr. Muhammad Azhar, an officer of Pakistan Audit and Accounts Services (PA&AS) BS-20, presently posted as Chief Finance and Accounts Officer in Ministry of Maritime Affairs, Islamabad is posted/transferred as Member (Finance), National Highway Authority (NHA) on deputation basis for a period of three (03) years on standard terms and conditions with immediate effect and until further orders.

JAMAL HAIDER,  
Section Officer (Road-I).

## DEPARTMENT OF THE AUDITOR GENERAL OF PAKISTAN

Islamabad, the 19th August, 2020

**No. 769/CA-III/1-67/2003/Vol-I(SI.67).**—Mr. Majid Saeed Ranjha, a BS-19 officer of Pakistan Audit & Accounts Service, presently posted as Director (Legal), AGP Office, Islamabad, is transferred and his services are placed at the disposal of Naya Pakistan Housing and Development Authority, Islamabad, as Joint Executive Director Internal Audit, on deputation basis, on standard terms and conditions, with immediate effect and until further orders.

**No. 41-Dir(A)/2-4/20.**—The Auditor General of Pakistan has been pleased to order postings/transfers of following officers of the Pakistan Audit & Accounts Service, with immediate effect and until further orders:-

Sr. #	Name of Officers M/S	From	To	Remarks
1.	Zeba Gul, BS-19/PA&AS	Controller Military Accounts (Pension), Lahore	Deputy CAOs/GB Pakistan Railways HQ, Lahore	Against a vacant post
2.	Aqeel Nawaz Siddiqui, BS-19/PA&AS	Awaiting posting at AGP, Office, Islamabad	Director (Legal) AGP Office, Islamabad	vice Mr. Majid Saeed Ranjha who proceeded on deputation
3.	Anwar Khan, BS-19/PA&AS	Director (HQ), District Government, KP Peshawar	Director PAAA, Islamabad	Against a vacant post
4.	Riazat Ali Shah, BS-19/PA&AS	Repatriation from deputation as Director (Finance) PGMI/ AMC/Lahore General Hospital, Lahore	Director Audit, District Government, Punjab (North), Lahore	Vice Sl. No. 5
5.	Sadia Saleem, BS-19/PA&AS	Director Audit, District Govt. Punjab (North), Lahore	Controller Military Accounts (Pension), Lahore.	Vice Sl. No. 1
6.	Amin Ullah Khan, BS-19/PA&AS	Director Audit, DG Audit Works Federal, Islamabad	Director (HQ), District Government, KP. Peshawar.	Vice Sl. No. 3
7.	Jan Israr, BS-19/PA&AS	Director District Audit Abbottabad	Director, O/o. DAG (North) Peshawar	Against a vacant post
8.	Syed Bilal Ahmad Shah, BS-18/PA&AS	Repatriation from deputation as Deputy Director Accounts O/o. the Central Police Office, Police Department KP, Peshawar.	Director, District Audit Abboattabad (OPS).	Vice Sl. No. 7

ZULFIQAR KHAN,  
Director (Admn).



Islamabad, the 18th August, 2020

**No. 406/PAAS-II/35-2017.**—Consequent upon her in-service death on 22nd July, 2020, as intimated *vide* O/o. Controller General of Accounts/Director General MIS/FABS Islamabad's Letter No. MIS/FABS/Admn/394-2017/1845 dated 10th August, 2020, Ms. Samina Yasmin, a BS-18 officer of Pakistan Audit & Accounts Service, has passed away on 22nd July, 2020. May Allah Almighty rest her soul in peace. Aameen.

Her name is struck off from the strength of Pakistan Audit & Accounts Service with effect from 22nd July, 2020. She was going to retire from Government Service on 25th September, 2020. This office Notification No. 187/PAAS-II/35-2017 dated 30th March, 2020 is cancelled/withdrawn *ab-initio*.

NADIA USMAN,  
Assistant Auditor General (PAAS).

Islamabad. the 17th August, 2020

**No. 496/Estt-C/01-2016-I.**—Consequent upon attaining the age of Superannuation, Mr. Ghulam Haider, Audit Officer O/o. the Director General Audit, Power, Lahore shall stand retired from Government Service on 31st October, 2020 (his date of birth being 1st November, 1960).

**No. 499/Estt-C/02-2020.**—Consequent upon attaining the age of Superannuation, Mr. Shahid Anjum, Audit Officer O/o. the Director General Audit, Works (Federal), Islamabad shall stand retired from Government Service on 30th April, 2021 (his date of birth being 1st May, 1961).

Islamabad, the 18th August, 2020

**No. 505/Estt-C/25-2018.**—Consequent upon acceptance of his option for pre-mature retirement Mr. Qamar Shahbaz, Assistant Audit Officer (BPS-17), of the O/o. the Director General Audit Federal Government Sub Office, Quetta shall stand retired from Government Service on 1st September, 2020 (his date of birth is 22nd February, 1961 & joined the service on 3rd December, 1984).

SYED WASEEM ABBAS,  
Audit Officer (Establishment).

[OFFICE OF THE CONTROLLER GENERAL OF ACCOUNTS]

Islamabad, the 17th August, 2020

**No. 428/CGA/PAAS/1-12/2017.**—Consequent upon posting/transfer *vide* this office Notification No. 421/CGA/PAAS/1-12/2017 dated 12th August, 2020 and Auditor General of Pakistan Notification No. 38-Dir(A)/2-2/20 dated 6th August, 2020, Mr. Maqbool Ahmed Gondal, a BS-21 officer of Pakistan Audit & Accounts Service, has relinquished the charge of the post of Accountant General Punjab, Lahore on 13th August, 2020.

**No. 538/CGA/Admn-I/03-82/2009.**—Consequent upon his posting in Ministry of Poverty Alleviation, Islamabad *vide* this office Notification No. 459/CGA/Estt/P.T/Cadared-Posts/2020 dated 6th July, 2020, Ms. Sobia Nawaz, Accounts Officer (BS-18) of this office has relinquished the charge of her post on 23rd July, 2020.

Islamabad, the 18th August, 2020

**No. 542/CGA/Admn-I/3-90/2010.**—In pursuance of this office Notification No. 363/CGA/Promotion/80-C/Special DPCs/2020 dated 19th June, 2020, on the recommendation of DPC for promotion of AAOs to AOs, Mr. Asad Iqbal, of O/o. the AG Punjab, Lahore has assumed the charge of the post of Accounts Officer (BS-18) to actualize his promotion in this office on 20th May, 2020.

Islamabad, the 17th August, 2020

**No. 551/CGA/Admn-I/35-3/2020(23).**—In pursuance of Section-13 of Civil Servants Act, 1973, Mr. Noor Muhammad, Senior Auditor (BS-16), of office of the DBA Pak. PWD, Islamabad, on attaining the age of superannuation shall stand retired from Government Service with effect from 5th October, 2021 (his date of birth 5th October, 1961).

JIBRAN KHAN DURRANI,  
Assistant Controller General of Accounts (Admn).

Islamabad, the 19th August, 2020

**No. 374/10-22/CGA/Discipline/2020.**—Mr. Hassan Tariq Sheikh, Accounts Officer, office of the Accountant General, KP Peshawar, was charged with "Inefficiency & Misconduct" under Government Servants (E&D) Rules-1973. The inquiry was conducted for purpose and the officer was served with Show Cause Notice. On receipt of his reply there to and as result of personal hearing afforded to him, the case has been considered by Deputy CGA being the Authorized Officer, in the light of fact/findings of the Inquiry Report and has decided to impose minor penalty of "Censure" in the light of Rule-4 (a) (i) of Government Servants (E&D) Rules-1973.

**No. 375/10-11/CGA/Discipline/2015.**—Mr. Sardar Muhammad Accounts Officer, of AG KP Peshawar was charged with "In-efficiency, Misconduct and Corruption". The inquiry was conducted under E&D Rules-1973 for the purpose.

Now since, the officer has been retired from Government Service on attaining the age of superannuation, the Deputy Controller General of Accounts in his capacity as Authorized Officer, has been pleased to abate the disciplinary case against the above named officer in term of Rules 54(A) of FR & SR and Rules-417(A) of CSR.

NAVEED AKBAR,  
Accounts Officer (Discipline).

## ELECTION COMMISSION OF PAKISTAN

Islamabad, the 25th August, 2020

**No. F.15(44)/2005-Estt-I.**—Mr. Muhammad Ali, a BS-18 officer of the Election Commission of Pakistan, presently posted as District Election Commissioner, Ziarat, is transferred and posted as District Election Commissioner, Lakki Marwat with immediate effect and until further orders.

This issues with the approval of the Hon'ble Chief Election Commissioner of Pakistan.

**No. F.3(11)/2018-Estt-I(Vol-II).**—The postings/transfers of the following officers under the Election Commission of Pakistan are made with immediate effect and until further orders on administrative grounds and in the public interest:-

S. No.	Name of Officers	From	To
1	2	3	4
1.	Mr. Adnan Bashir	Director (LGE-KP), ECP Secretariat, Islamabad	Director (Research, Strategic Planning and Overseas Pakistanis), ECP Secretariat, Islamabad.
2.	Mr. Nadeem Qasim	Director (Elections), ECP Secretariat, Islamabad	Director (Electoral Rolls), ECP Secretariat, Islamabad (He will continue to work as Spokesperson of ECP
3.	Mr. Tahir Hassan	Director (Electoral Rolls), ECP Secretariat, Islamabad	Director in the O/o. PEC, Sindh, Karachi.

2. This issues with the approval of the Hon'ble Chief Election Commissioner of Pakistan.

Islamabad, the 27th August, 2020

**No. F.3(4)/2020-Estt-I.**—Mr. Muhammad Aslam, a BS-18 officer of Election Commission of Pakistan, presently posted as Deputy Director (Admn) in office of the Provincial Election Commissioner, Punjab is assigned additional charge of the vacant post of Deputy Director (Estt) in office of the Provincial Election Commissioner, Punjab with immediate effect for a period of 3 months or till the regular appointment against the said post whichever is earlier.

This issues with the approval of the Secretary, Election Commission.

**No. F.3(2)/2020-Estt-I.**—The postings/transfers of following officers of Election Commission of Pakistan are

hereby made with immediate effect and until further orders on administrative grounds:-

S.#	Name of Officers & Designation	From	To
1.	Mr. Aaber Farooque, Assistant Director	In O/o. ADG (Gender Affairs)	LGE-Punjab Branch
2.	Mr. Muhammad Siddique, Assistant Director	In O/o. Director (MIS)	Estt-II Branch

2. This issues with the approval of Secretary, Election Commission of Pakistan.

Islamabad, the 28th August, 2020

**No. F.3(2)/2020-Estt-I.**—The postings/transfers of the following officers under the Election Commission of Pakistan are made with immediate effect and until further orders on administrative grounds and in the public interest:-

S. No.	Name of Officers	From	To
1	2	3	4
1.	Mr. Tahir Hassan	Director (Electoral Rolls) in the ECP Secretariat, Islamabad	Director in the office of PEC, Balochistan, Quetta
2.	Mr. Pervaiz Ahmed Kalhoro	Regional Election Commissioner, Larkana	Director in the office of PEC, Sindh, Karachi.
3.	Mr. Noor-ul-Khitab	District Election Commissioner, Lower Dir	District Election Commissioner, Swabi
4.	Mr. Raham Zada	District Election Commissioner, Swabi	District Election Commissioner, Lower Dir
5.	Mr. Muhammad Mehfooz Alam	Deputy Director in the O/o. PEC, Sindh, Karachi.	District Election Commissioner, Tharparkar
6.	Mr. Aamir Hussain Shah	District Election Commissioner, Tharparkar	Deputy Director in the O/o. PEC, Sindh, Karachi.
7.	Mr. Shahabuddin	Assistant Director in the O/o. PEC, Sindh, Karachi	Election Officer in the O/o. DEC, Shaheed Benazirabad

S. No.	Name of Officers	From	To
1	2	3	4
8.	Mr. Mushtaq Ali Mastoi	Election Officer in the O/o. REC, Hyderabad	Election Officer in the O/o. DEC, Badin
9.	Mr. Muhammad Hassan	Election Officer in the O/o. DEC, Badin	Election Officer in the O/o. REC, Hyderabad
10.	Mr. Kanwar Shujat Ali	Election Officer in the O/o. DEC, Hyderabad	Election Officer in the O/o. DEC, Umerkot

Besides, the post of Election Officer shifted alongwith headquarter to ECP Secretariat, Islamabad and re-designated as Assistant Director *vide* Sanction Letter No. F. 3(12)/2011-Estt-I dated 15th May, 2019 is hereby abolished with effect from 24th August, 2020.

Provincial Election Commissioner, Balochistan, Quetta is directed to make adjustments of officials working against the above posts on the vacant positions at his office or field organization. However, it is requested to send proposal of adjustment of the post of BS-18 to this office for placement/posting of the officer.

This issues with the approval of the Hon'ble Chief Election Commissioner.

IMRAN ZAFAR,  
Deputy Director (Estt-I).

2. This Commission's Notification No. F.3(11)/2018-Estt-I-Vol-II(3), dated the 25th August, 2020 pertains to the transfer of Mr. Tahir Hassan is hereby revoked and amended to the extent of officer concerned.

This issues with the approval of the Hon'ble Chief Election Commissioner of Pakistan.

Islamabad, the 31st August, 2020

**No. F.3(11)/2018-Estt-I(Vol-II).**—The Hon'ble Chief Election Commissioner of Pakistan being Head of Department, has been pleased to abolish the following posts created for defunct Lehri District *vide* Sanction Letter No. F.3(12)/2011-Estt-I dated 24th July, 2013 with effect from 24th August, 2020:-

Sl. No.	Name of the Posts	Number of Post
1.	District Election Commissioner (BS-18)	1
2.	Senior Assistant (BS-16)	1
3.	Junior Personal Assistant (BS-14)	1
4.	Data Entry Operator (BS-14)	1
5.	Junior Assistant (BS-11)	1
6.	Sub-Assistant (BS-19)	1
7.	Staff Car Driver (BS-5)	1
8.	Naib Qasid (BS-2)	2
9.	Chowkidar (BS-2)	1
	<b>Total:</b>	<b>10</b>

MINISTRY OF ENERGY

(Petroleum Division)

[POLICY WING]

Islamabad, the 15th July, 2020

**No. P.W-3(159)/2020-Admn.**—Mr. Abdul Jabbar Memon, presently posted as Director General (LGs)/BS-20, Policy Wing, Petroleum Division, Ministry of Energy is assigned additional charge of the post of Director General (PC)/BS-20 with effect from 8th July, 2020 in addition to his own duties as a stop gap arrangement for a period of ninety (90) days or till the posting of a regular incumbent, whichever is earlier.

This issues with the approval of Secretary, Petroleum Division, Ministry of Energy.

Islamabad, the 17th July, 2020

**No. 3(104)/2006-Oil.**—In pursuance of National Institute of Management, Lahore's Notification No. Supdt/NIM/Notification/29th MCMC/2020 dated 3rd July, 2020, on completion of 29th Mid Career Management Course, Mr. Abdul Rasheed Jokhio, Deputy Director (Technical) BS-18/Director (Technical) BS-19 on acting charge, has joined his duties against the post of Director (Gas)/BS-19 in the Directorate General (Gas), Policy Wing, Petroleum Division with effect from 6th July, 2020.

**No. 3(81)/2000-Oil.**—Mr. Dil Nawaz Khan, Deputy Director (F&P), Policy Wing (Petroleum Division), Ministry of Energy is allowed retirement from Government Service on attaining the age of superannuation with effect from 14th January, 2021.

The officer is also allowed availing the option of encashment in lieu of leave preparatory to retirement for a period of 365 days with effect from 15th January, 2020 to 14th January, 2021.

This issues with the approval of competent authority *i.e.* Secretary, Petroleum Division, Ministry of Energy.

Islamabad, the 23rd July, 2020

**No. 3(56)/91-Oil.**—Mr. Iltaf Hussain Ansari, Director (Non-Tech/BS-19), Policy Wing, Petroleum Division, Ministry of Energy is granted seven (07) days LFP. with effect from 8th June, 2020 to 14th June, 2020.

This issues with the approval of the Secretary, Petroleum Division.

Islamabad, the 27th July, 2020

**No. 3(99)/2005-Oil.**—In pursuance of National Institute of Management, Karachi's Notification No. 13/1/2020-MCMC-(Coord) dated 10th July, 2020, on completion of 29th Mid Career Management Course, Mr. Kashif Ali, Deputy Director (Technical) BS-18/Director (Technical) BS-19 on acting charge, has joined his duties against the post of Director (Production)/BS-19 in the Directorate General (PC), Policy Wing, Petroleum Division, Ministry of Energy with effect from 13th July, 2020.

Islamabad, the 19th August, 2020

**No. PW-2(34)/2006-Admin.**—In pursuance of Controller General of Account's Notification No. 477-CGA/Estt/P.T/Cadered-Posts/2020/DBA dated 15th July, 2020, Mr. Shakir Ullah Khan, Accounts Officer (BS-18) assumed the charge of the post of Deputy Director (Finance & Pricing)/BS-18 in Policy Wing, Petroleum Division, Ministry of Energy with effect from 4th August, 2020.

This issues with the approval of Secretary, Petroleum Division, Ministry of Energy.

The notification of even number dated 6th August, 2020 is amended accordingly.

Islamabad, the 27th August, 2020

**No. 3(117)/2009-Oil-Deptt.**—*Ex-Pakistan* leave granted on half average pay to Syed Muhammad Ahsen, Deputy Director (Non-Technical)/BS-18 *vide* notification of even number dated 17th May, 2020 is hereby extended for further period of Ninety (90) days with effect from 16th August, 2020.

This issues with the approval of the Secretary, Petroleum Division.

Islamabad, the 28th August, 2020

**No. PW-3(152)/2019-Admn.**—Dr. Shafi-ur-Rehman, currently posted as Director General (SP)/BS-20, Policy Wing, Petroleum Division, Ministry of Energy is assigned additional charge of the post of Director General (Oil)/BS-20 with effect from 17th August, 2020 in addition to his own duties for a period of ninety (90) days or till the posting of a regular incumbent, whichever is earlier.

This issues with the approval of Secretary, Petroleum Division, Ministry of Energy.

**No. 3(152)/2019-Admn.**—Dr. Shafi-ur-Rehman Afridi, Director General (SP)/BS-20 currently assigned additional charge of the post of Director General (Oil)/BS-20, Policy Wing, Petroleum Division, Ministry of Energy, Islamabad is granted 68 days LFP on medical grounds with effect from 7th June, 2020 to 13th August, 2020 (suffix public holidays).

This issues with the approval of Secretary, Petroleum Division.

**No. 3(152)/2019-Admn.**—Dr. Shafiq-ur-Rehman Afridi, Director General (SP)/BS-20 currently assigned additional charge of the post of Director General (Oil)/BS-20, Policy Wing, Petroleum Division, Ministry of Energy, Islamabad has assumed charge of the post of Director General (BS-20) after availing of 68 days LFP on medical grounds.

This issues with the approval of Secretary, Petroleum Division.

KHALID MANSOOR,  
Deputy Director (Admn).

---

MINISTRY OF FEDERAL EDUCATION &  
PROFESSIONAL TRAINING

Islamabad, the 31st August, 2020

**No. F.5-2/2019-Misc-PMI.**—In pursuance of this Ministry's Notification No. 5-2/2019-Misc-PMI dated 25th August, 2020, Mr. Ashraf Nadeem, a BS-19 officer of Federal Directorate of Education has assumed the charge of the post of Director (BS-19) in Pakistan Manpower Institute with effect from 26th August, 2020.

IRFAN ULLAH,  
Section Officer (PT-II).

Islamabad, the 31st August, 2020

**No. F.3-(8)/2015-NCC/RE.**—In continuation of this Ministry's notification of even number dated 17th February, 2020, Mr. Muhammad Rafique Tahir, Joint Educational Advisor, National Curriculum Council (NCC)/Director General, Directorate General of Religious Education (DGRE), Ministry of Federal Education & Professional Training (M/o FE&PT) in nominated as Convener of the Teaching of the Holy Quran (ToHQ) Committee on account of the transfer of Mr. Muhammad Saleem Ahmad Ranjha, Additional Secretary, M/o. FE&PT/*ex-Convener* of the ToHQ Committee.

This issues with the approval of the competent authority.

**No. F.4-2/2015-NCC/RE.**—On the recommendation of Departmental Selection Committee (DSC) as well as with the approval of appointing authority and having been declared medically fit, Ms. Rubina Kousar, has assumed the charge of the post of Assistant Educational Adviser (PPS-08) on 5th June, 2020 on contract basis for a period

of one (01) year in National Curriculum Council (NCC) Secretariat under the Ministry of Federal Education and Professional Training, Islamabad.

This issues with the approval of the competent authority.

**No. F.4-2/2015-NCC/RE.**—On the recommendation of Departmental Selection Committee (DSC) as well as with the approval of appointing authority and having been declared medically fit, Mr. Ikramullah, has assumed the charge of the post of Librarian (PPS-07) on 28th May, 2020 on contract basis for a period of (01) year in National Curriculum Council (NCC) Secretariat under the Ministry of Federal Education and Professional Training, Islamabad.

This issues with the approval of the competent authority.

**No. F.4-2/2015-NCC/RE.**—On the recommendation of Departmental Selection Committee (DSC) as well as with the approval of appointment authority and having been declared medically fit, Mr. Asad Sardar, has assumed the charge of the post of Education Officer (PPS-07) on 28th May, 2020 on contract basis for a period of one (01) year in National Curriculum Council (NCC) Secretariat under the Ministry of Federal Education and Professional Training, Islamabad.

This issues with the approval of the competent authority.

**No. F.4-2/2015-NCC/RE.**—On the recommendation of Departmental Selection Committee (DSC) as well as with the approval of appointment authority and having been declared medically fit, Ms. Abida Munir, has assumed the charge of the post of IT-Expert (PPS-07) on 3rd June, 2020 on contract basis for a period of one (01) year in National Curriculum Council (NCC) Secretariat under the Ministry of Federal Education and Professional Training, Islamabad.

This issues with the approval of the competent authority.

FAROOQUE AIZAM ABRO,  
Assistant Educational Adviser.

MINISTRY OF FINANCE, REVENUE AND ECONOMIC  
AFFAIRS

(Revenue Division)

[FEDERAL BOARD OF REVENUE]

Islamabad, the 5th May, 2020

**No. 0730-IR-IV/2020.**—On attaining the age of superannuation Mr. Maqsood Ahmed Khilji, Inspector (BS-16), Corporate Regional Tax Office, Lahore shall stand retired from Government Service with effect from 16th July, 2020.

**No. 0721-IR-IV/2020.**—On attaining the age of superannuation Mr. Shahid Bashir, Assistant Private Secretary (BS-16), Regional Tax Office, Islamabad shall stand retired from Government Service with effect from 18th May, 2020.

**No. 0731-IR-IV/2020.**—On attaining the age of superannuation Mr. Asghar Ali Badami, Inland Revenue Officer (BS-16), Regional Tax Office, Hyderabad shall stand retired from Government Service with effect from 4th June, 2020.

**No. 0729-IR-IV/2020.**—On attaining the age of superannuation Mr. Ali Asghar Solangi, Assistant Private Secretary (BS-16), Regional Tax Office-II, Karachi shall stand retired from Government Service with effect from 31st May, 2020.

**No. 0723-IR-IV/2020.**—The Government of Pakistan announces with deep regret the sad demise of Abdul Naeem Khan, Office Superintendent (BS-16), Regional Tax Office-III, Karachi on 14th February, 2020. Abdul Naeem Khan was born on 6th July, 1960. He joined Government Service on 7th March, 1979.

The Government of Pakistan wishes to place on record its appreciation of the dedicated services rendered by the deceased officer.

In expressing its sense of grief at his death, the Government of Pakistan Conveys its commiserations to the members of the bereaved family. May his soul rest in eternal peace and may Allah give patience and fortitude to the family members to bear this irreparable loss.

Islamabad, the 7th May, 2020

**No. 0765-IR-IV/2020.**—Ms. Humera Akbar, Inspector-IR (BS-16), Regional Tax Office, Islamabad is granted 2 years (730 days) leave *ex-Pakistan* without pay with effect from 28th May, 2020 to 27th May, 2022 to visit France.

The Federal Board of Revenue, Government of Pakistan has no objection to the proceeding abroad of the above named Inspector-IR during her leave period.

**No. 0766-IR-IV/2020.**—On attaining the age of superannuation Mr. Safdar Hussain, Inland Revenue Officer (BS-16), Regional Tax Office, Islamabad stood retired from Government Service with effect from 7th April, 2020.

#### CORRIGENDUM

**No. 0746-IR-IV/2020.**—On attaining the age of superannuation Mr. Ayaz Akbar, Inland Revenue Officer (BS-16), Corporate Regional Tax Office, Lahore stood retired from Government Service with effect from 30th April, 2020.

This supersedes Board's earlier Notification No. 2694-IR-IV/2019 dated 7th October, 2019.

Islamabad, the 8th May, 2020

**No. 0770-IR-IV/2020.**—On attaining the age of superannuation Mr. Mohsin Alam Khan, Inland Revenue Officer (BS-16), Large Taxpayers Unit, Karachi stood

retired from Government Service with effect from 1st May, 2020.

Islamabad, the 11th May, 2020

**No. 0799-IR-IV/2020.**—Mr. Sajid Ali, Inland Revenue Officer (BS-16), Large Taxpayers Unit, Islamabad is transferred and posted at AEOI Zone, Islamabad with immediate effect and until further orders.

If the above named officer is drawing Performance Allowance prior to issuance of this notification, he shall continue to draw the same on the new place of posting.

He is requested to relinquish/assume charge, using online HRMS facility made available at all FBR major field offices or by using IJP login.

**No. 0792-IR-IV/2020.**—On attaining the age of superannuation Mr. Muhammad Sadiq, Administrative Officer (BS-17), Regional Tax Office, Faisalabad shall stand retired from Government Service with effect from 14th June, 2020.

**No. 0793-IR-IV/2020.**—The Government of Pakistan announces with deep regret the sad demise of Mr. Mubeen Baloch, Inland Revenue Officer (BS-16), Regional Tax Office, Hyderabad on 6th April, 2020. Mr. Mubeen Baloch was born on 5th June, 1962. He joined Government Service on 31st March, 1981.

The Government of Pakistan wishes to place on record its appreciation of the dedicated services rendered by the deceased officer.

In expressing its sense of grief at his death, the Government of Pakistan Conveys its commiserations to the members of the bereaved family. May his soul rest in eternal peace and may Allah give patience and fortitude to the family members to bear this irreparable loss.

Islamabad, the 13th May, 2020

**No. 0819-IR-IV/2020.**—On attaining the age of superannuation Mr. Muhammad Ayub Jan, Office Superintendent (BS-16), Regional Tax Office, Peshawar stood retired from Government Service with effect from 30th April, 2020.

**No. 0820-IR-IV/2020.**—On attaining the age of superannuation Mr. Najmul Hassan, Inspector (BS-16), Corporate Regional Tax Office, Karachi shall stand retired from Government Service with effect from 3rd June, 2020.

**No. 0814-IR-IV/2020.**—On attaining the age of superannuation Mr. Muhammad Kabir Khan, Inland Revenue Officer (BS-16), Corporate Regional Tax Office, Karachi stood retired from Government Service with effect from 30th April, 2020.

**No. 0817-IR-IV/2020.**—Consequent upon his selection as Assistant Manager (Accounts & Finance) (BPS-17) in Water and Power Development Authority, Lahore *vide* their Appointment Letter No. Aii/Admn-GMFC/Apptt-AM(A&F)B-17/890 dated 20th March, 2020, Mr. Muhammad Qaisar Arif, Inspector-IR (BS-16), Corporate Regional Tax Office, Lahore is relieved of his duties to join his new assignment in the Water and Power Development Authority, Lahore.

Mr. Muhammad Qaisar Arif is allowed the right of reversion/lien for the period of one year from the date of relieving.

Islamabad, the 19th May, 2020

**No. 0908-IR-IV/2020.**—Mr. Muhammad Aurangzeb (Personnel No. 50035518), APS (BS-16), Federal Board of Revenue (HQ), Islamabad is granted 30 days leave on full pay with effect from 11th May, 2020 to 9th June, 2020.

He will be entitled to draw Performance Allowance-FBR, if already drawing, during the leave period as per standing instruction on the subject of IJP.

This issues with the approval of Chief (Management), FBR.

#### CORRIGENDA

**No. 0870-IR-IV/2020.**—On attaining the age of superannuation Mr. Muhammad Achar Dahri, Inland Revenue Officer (BS-16), Regional Tax Office, Hyderabad shall stand retired from Government Service with effect from 7th June, 2020.

This supersedes Board's earlier Notification No. 0359-IR-IV/2020 dated 27th February, 2020.

Islamabad, the 20th May, 2020

**No. 0883-IR-IV/2020.**—On attaining the age of superannuation Mr. Pervaiz Akhtar, Inland Revenue Officer (BS-16), Corporate Regional Tax Office, Lahore stood retired from Government Service with effect from 5th April, 2020.

This supersedes Board's earlier Notification No. 2429-IR-IV/2019 dated 16th September, 2019.

**No. 0879-IR-IV/2020.**—On attaining the age of superannuation Mr. Khalid Mansoor, Office Superintendent (BS-16), Regional Tax Office, Faisalabad stood retired from Government Service with effect from 13th April, 2020.

**No. 0878-IR-IV/2020.**—On attaining the age of superannuation Khwaja Azamuddin, Administrative Officer (BS-17), Regional Tax Office-III, Karachi shall stand retired from Government Service with effect from 6th September, 2020.

**No. 0877-IR-IV/2020.**—On attaining the age of superannuation Mr. Afzal Hussain Siddiqui, Inspector-IR (BS-16), Regional Tax Office-III, Karachi shall stand retired from Government Service with effect from 30th June, 2020.

**No. 0876-IR-IV/2020.**—On attaining the age of superannuation Mr. Salahuddin Mahmood, Inland Revenue Officer (BS-16), Regional Tax Office-II, Karachi shall stand retired from Government Service with effect from 14th June, 2020.

**No. 0875-IR-IV/2020.**—On attaining the age of superannuation Syed Mateenuddin, Inland Revenue Officer (BS-16), Regional Tax Office-III, Karachi shall stand retired from Government Service with effect from 21st July, 2020.

**No. 0907-IR-IV/2020.**—In pursuance of Finance Division, Islamabad's O.M. No. F.1-239/2007-HR-II dated 27th April, 2020, the services of Mr. Muhammad Saleem, Assistant Private Secretary (BS-16), Finance Division, are placed at the disposal of Federal Board of Revenue (HQ) Islamabad, on deputation basis, for initial period of three years on standard terms and conditions with immediate effect.

Unless directed otherwise by the competent authority, the officer shall stand repatriated to his parent department *i.e.* Finance Division, Islamabad on completion of deputation period.

This issues with the approval of Chairperson, FBR.

Islamabad, the 21st May, 2020

**No. 0898-MIR-IV/2020.**—Postings/Transfers of the following Inland Revenue Officers (BS-16) are made with immediate effect until further orders:-

S #	Name of Officers	From	To
1.	Altaf Hussain	Regional Tax Office, Peshawar	Regional Tax Office, Peshawar
2.	Israr Ali Khan Yousafzai	Regional Tax Office, Peshawar	Regional Tax Office, Peshawar
3.	Abdul Aziz	Regional Tax Office, Peshawar	Regional Tax Office, Peshawar
4.	Muhammad Sajid Khan	Regional Tax Office, Peshawar	Regional Tax Office, Peshawar
5.	Kamran Samin	Regional Tax Office, Peshawar	Regional Tax Office, Peshawar

S #	Name of Officers	From	To
6.	Muhammad Shakeel	Regional Tax Office, Peshawar	Regional Tax Office, Peshawar
7.	Farooq Ahmad Baig	Regional Tax Office, Peshawar	Regional Tax Office, Peshawar
8.	Abdur Razaq	Regional Tax Office, Peshawar	Regional Tax Office, Peshawar
9.	Abdul Wadood Khan Afridi	Regional Tax Office, Peshawar	Regional Tax Office, Peshawar
10.	Niaz Muhammad Khan	Regional Tax Office, Peshawar	Regional Tax Office, Peshawar
11.	Muhammad Darwesh	Regional Tax Office, Peshawar	Regional Tax Office, Peshawar
12.	Raza Khan	Regional Tax Office, Peshawar	Regional Tax Office, Peshawar
13.	Javed Iqbal	Regional Tax Office, Peshawar	Regional Tax Office, Peshawar
14.	Sabz Ali	Internal Audit (IR), Peshawar	Regional Tax Office, Peshawar
15.	Muhammad Zahir Jan	Internal Audit (IR), Peshawar	Regional Tax Office, Peshawar
16.	Muhammad Khalid S/o. Awaz Gul	Internal Audit (IR), Peshawar	Regional Tax Office, Peshawar
17.	Zia-ur-Rehman	Intelligence & Investigation (IR), Peshawar	Regional Tax Office, Peshawar

S #	Name of Officers	From	To
18.	Aziz-ur-Rehman	Internal Audit (IR), Peshawar	Internal Audit (IR), Peshawar
19.	Muhammad Khalid S/o. Abdur Rashid Khan	Regional Tax Office, Peshawar	Regional Tax Office, Abbottabad
20.	Kamil Shah	Regional Tax Office, Peshawar	Regional Tax Office, Abbottabad
21.	Sardar Ghulam Mustafa	Regional Tax Office, Abbottabad	Regional Tax Office, Abbottabad
22.	Muhammad Shaukat Nawaz	Regional Tax Office, Abbottabad	Regional Tax Office, Abbottabad
23.	Nasir Khan Abbasi	Large Taxpayers Unit, Islamabad	Regional Tax Office, Islamabad
24.	Imdad Hussain	Regional Tax Office, Peshawar	Large Taxpayers Unit, Islamabad
25.	Syed Imran Rasool	Regional Tax Office, Peshawar	Intelligence & Investigation (IR), Peshawar
26.	Abdul Wakil	Inland Revenue (App), Peshawar	Inland Revenue (App), Peshawar
27.	Tanveer Muhammad	Regional Tax Office, Peshawar	Large Taxpayers Unit, Islamabad
28.	Zahir Shah	Internal Audit (IR), Peshawar	Large Taxpayers Unit, Islamabad
29.	Naveed Ahmad	Large Taxpayers Unit, Islamabad	Large Taxpayers Unit, Islamabad

S #	Name of Officers	From	To
30.	Muhammad Ejaz	Large Taxpayers Unit, Islamabad	Large Taxpayers Unit, Islamabad
31.	Nisar Ahmad Malik	Large Taxpayers Unit, Islamabad	Large Taxpayers Unit, Islamabad
32.	Rana Mukhtar Anjum	Large Taxpayers Unit, Islamabad	Large Taxpayers Unit, Islamabad
33.	Sajid Farooq	Regional Tax Office, Rawalpindi	Regional Tax Office, Rawalpindi
34.	Syed Ather Ali Bokhari	Regional Tax Office, Rawalpindi	Regional Tax Office, Rawalpindi
35.	Muhammad Qasim Saleem	Regional Tax Office, Rawalpindi	Regional Tax Office, Rawalpindi
36.	Zahid Munir	Regional Tax Office, Rawalpindi	Regional Tax Office, Rawalpindi
37.	Sajjad Ahmed Abbasi	Regional Tax Office, Rawalpindi	Regional Tax Office, Rawalpindi
38.	Muhammad Haroon	Regional Tax Office, Rawalpindi	Regional Tax Office, Rawalpindi
39.	Syed Anwar Hussain Sherazi	Internal Audit (IR), Rawalpindi	Regional Tax Office, Rawalpindi

2. If the above named officers are drawing Performance Allowance prior to issuance of this notification, they shall continue to draw the same on the new place of posting.

3. They are requested to relinquish/assume charge, using online HRMS facility made available at all FBR major field offices or by using IJP login.



**No. 0899-MIR-IV/2020.**—Postings/transfers of the following Inland Revenue Officers (BS-16) are made with immediate effect until further orders:-

S#	Name of Officers	From	To
1.	Saghir Ahmed	Corporate Regional Tax Office, Karachi	Corporate Regional Tax Office, Karachi
2.	Abdul Saleem Khan	Corporate Regional Tax Office, Karachi	Corporate Regional Tax Office, Karachi
3.	Muhammad Shahid	Corporate Regional Tax Office, Karachi	Corporate Regional Tax Office, Karachi
4.	Muhammad Shaheen Akhtar Ansari	Corporate Regional Tax Office, Karachi	Corporate Regional Tax Office, Karachi
5.	Mehboob Hussain	Corporate Regional Tax Office, Karachi	Corporate Regional Tax Office, Karachi
6.	Syed Asif Ali	Corporate Regional Tax Office, Karachi	Corporate Regional Tax Office, Karachi
7.	Muhammad Asim Khan	Corporate Regional Tax Office, Karachi	Corporate Regional Tax Office, Karachi
8.	Nasir Mahmood	Corporate Regional Tax Office, Karachi	Corporate Regional Tax Office, Karachi
9.	Arshad Mehmood	Corporate Regional Tax Office, Karachi	Corporate Regional Tax Office, Karachi
10.	Muhammad Amin	Corporate Regional Tax Office, Karachi	Corporate Regional Tax Office, Karachi
11.	Muhammad Masood Siddiquei	Corporate Regional Tax Office, Karachi	Corporate Regional Tax Office, Karachi
12.	Iqbal Hussain	Corporate Regional Tax Office, Karachi	Corporate Regional Tax Office, Karachi
13.	Mst. Nasreen Begum	Corporate Regional Tax Office, Karachi	Corporate Regional Tax Office, Karachi
14.	Ziauddin Ahmed Siddiqui	Corporate Regional Tax Office, Karachi	Corporate Regional Tax Office, Karachi

S#	Name of Officers	From	To
15.	Muhammad Iqbal	Regional Tax Office-II, Karachi	Corporate Regional Tax Office, Karachi
16.	Ahmed Ali	Regional Tax Office-II, Karachi	Corporate Regional Tax Office, Karachi
17.	Maqsood Alam	Regional Tax Office-II, Karachi	Corporate Regional Tax Office, Karachi
18.	Muhammad Nadeem Khan	Regional Tax Office-II, Karachi	Regional Tax Office-II, Karachi
19.	Salahuddin Mehmood	Regional Tax Office-II, Karachi	Regional Tax Office-II, Karachi
20.	Noor-ul-Qamar Khan	Regional Tax Office-II, Karachi	Regional Tax Office-II, Karachi
21.	Khalid Akbar	Regional Tax Office-II, Karachi	Regional Tax Office-II, Karachi
22.	Muhammad Imteyaz Alam	Regional Tax Office-II, Karachi	Regional Tax Office-II, Karachi
23.	Muhammad Sami	Regional Tax Office-II, Karachi	Regional Tax Office-II, Karachi
24.	Muhammad Shahid Irfan	Regional Tax Office-II, Karachi	Regional Tax Office-II, Karachi
25.	Qaisar Yunus	Regional Tax Office-II, Karachi	Regional Tax Office-II, Karachi
26.	Muhammad Qamar Ali Khan	Regional Tax Office-II, Karachi	Regional Tax Office-II, Karachi
27.	Syed Majid Ali	Regional Tax Office-II, Karachi	Regional Tax Office-II, Karachi
28.	Mustafa Shaukat	Regional Tax Office-II, Karachi	Regional Tax Office-II, Karachi
29.	Sheikh Nazar Ahmed	Regional Tax Office-II, Karachi	Regional Tax Office-II, Karachi

S#	Name of Officers	From	To
30.	Muhammad Mubin Khan	Regional Tax Office-II, Karachi	Regional Tax Office-II, Karachi
31.	Manzar Kamal	Regional Tax Office-III, Karachi	Regional Tax Office-III, Karachi
32.	Khalid Hussan Burney	Regional Tax Office-III, Karachi	Regional Tax Office-III, Karachi
33.	Waqar Ahmed	Regional Tax Office-III, Karachi	Regional Tax Office-III, Karachi
34.	Syed Mateenuddin	Regional Tax Office-III, Karachi	Regional Tax Office-III, Karachi
35.	Muhammad Saleem Khatri	Regional Tax Office-III, Karachi	Regional Tax Office-III, Karachi
36.	Syed Zeeshan Haider	Regional Tax Office-III, Karachi	Regional Tax Office-III, Karachi
37.	Zia-ul-Hassan	Regional Tax Office-III, Karachi	Regional Tax Office-III, Karachi
38.	Syed Anjum Burney	Regional Tax Office-III, Karachi	Regional Tax Office-III, Karachi
39.	Najamul Hassan	Regional Tax Office-III, Karachi	Regional Tax Office-III, Karachi
40.	Muhammad Anwar Khan	Regional Tax Office-III, Karachi	Regional Tax Office-III, Karachi
41.	Zafar Mumtaz	Regional Tax Office-III, Karachi	Regional Tax Office-III, Karachi
42.	Syed Qamar Raza Rizvi	Regional Tax Office-III, Karachi	Regional Tax Office-III, Karachi
43.	Muhammad Ayaz	Regional Tax Office-III, Karachi	Regional Tax Office-III, Karachi
44.	Laeq Ahmed	Regional Tax Office-III, Karachi	Regional Tax Office-III, Karachi

S#	Name of Officers	From	To
45.	Javed Iqbal	Regional Tax Office-III, Karachi	Regional Tax Office-III, Karachi
46.	Muhammad Jawed	Regional Tax Office-III, Karachi	Regional Tax Office-III, Karachi
47.	Riaz Javed	Regional Tax Office-III, Karachi	Regional Tax Office-III, Karachi
48.	Muhammad Farooq	Regional Tax Office-III, Karachi	Regional Tax Office-III, Karachi
49.	Ajaz Ahmed S/o. Israr Ahmad	Regional Tax Office-III, Karachi	Regional Tax Office-III, Karachi
50.	Nadeem Ahmed Qureshi	Regional Tax Office-III, Karachi	Regional Tax Office-III, Karachi
51.	Kanwar Tariq	Regional Tax Office-III, Karachi	Regional Tax Office-III, Karachi
52.	Farid Alam	Regional Tax Office-III, Karachi	Regional Tax Office-III, Karachi
53.	Mushtaq Ahmed	Regional Tax Office-III, Karachi	Regional Tax Office-III, Karachi
54.	Abdul Mujeeb Khan	Regional Tax Office-III, Karachi	Regional Tax Office-III, Karachi
55.	Muhammad Ibrahim Khan	Regional Tax Office-III, Karachi	Large Taxpayers Unit Karachi
56.	Syed Muhammad Imtiaz	Regional Tax Office-III, Karachi	Large Taxpayers Unit Karachi
57.	Muhammad Naseem Akhtar	Regional Tax Office-III, Karachi	Large Taxpayers Unit Karachi
58.	Munir Hussain	Regional Tax Office-III, Karachi	Large Taxpayers Unit Karachi
59.	Syed Noorul Hamid	Large Taxpayers Unit, Karachi	Large Taxpayers Unit, Karachi

S#	Name of Officers	From	To
60.	Muhammad Nasir	Large Taxpayers Unit, Karachi	Large Taxpayers Unit, Karachi
61.	Alam Sher	Large Taxpayers Unit Karachi	Large Taxpayers Unit, Karachi
62.	Mahmood Mohiuddin	Large Taxpayers Unit-II, Karachi	Large Taxpayers Unit-II, Karachi
63.	Muhammad Ajmal	Large Taxpayers Unit-II, Karachi	Large Taxpayers Unit-II, Karachi
64.	Mr. Allah Warayo Larik	Large Taxpayers Unit-II, Karachi	Large Taxpayers Unit-II, Karachi
65.	Abdul Qadir Soomro	Intelligence & Investigation (IR), Hyderabad	Intelligence & Investigation (IR), Hyderabad
66.	Muhammad Azam Soomro	Regional Tax Office, Sukkur	Regional Tax Office, Sukkur
67.	Abdul Majeed Sangi	Regional Tax Office, Sukkur	Regional Tax Office, Sukkur
68.	Abdul Rahim Junejo	Regional Tax Office, Sukkur	Regional Tax Office, Sukkur
69.	Babu Ali Balouch	Regional Tax Office, Quetta	Regional Tax Office, Quetta

2. If the above named Officers are drawing Performance Allowance prior to issuance of this notification, they shall continue to draw the same on the new place of posting.

3. They are requested to Relinquish/Assume Charge, using online HRMS facility made available at all FBR major field offices or by using IJP login.

**No. 0897-MIR-IV/2020.**—Postings/transfers of the following Inland Revenue Officers (BS-16) are made with immediate effect until further orders:-

S#	Name of Officers	From	To
1.	Muhammad Khalil Ahmed	Regional Tax Office, Bahawalpur	Regional Tax Office, Bahawalpur
2.	Tanseer UI Hassan Tirmizi	Regional Tax Office, Bahawalpur	Regional Tax Office, Bahawalpur

S#	M/s. Name of Officers	From	To
3.	Hafiz Shabbir Ahmed	Regional Tax Office, Bahawalpur	Regional Tax Office, Bahawalpur
4.	Bisman Ahmed Sikandar	Regional Tax Office, Bahawalpur	Regional Tax Office, Bahawalpur
5.	Muhammad Suleman Khan	Regional Tax Office, Bahawalpur	Regional Tax Office, Bahawalpur
6.	Riaz Ahmad Balouch	Regional Tax Office, Bahawalpur	Regional Tax Office, Bahawalpur
7.	Najeeb ur Rehman	Regional Tax Office, Bahawalpur	Regional Tax Office, Bahawalpur
8.	Abdur Rehman Virk	Regional Tax Office, Bahawalpur	Regional Tax Office, Bahawalpur
9.	Aqeel Ur Rehman	Regional Tax Office, Bahawalpur	Regional Tax Office, Bahawalpur
10.	Muhammad Amir Baig	Regional Tax Office, Bahawalpur	Regional Tax Office, Bahawalpur
11.	Sheikh Iqbal Farooq	Regional Tax Office, Bahawalpur	Regional Tax Office, Multan
12.	Zulfiqar Ahmad Abbasi	Regional Tax Office, Bahawalpur	Regional Tax Office, Multan
13.	Masood Ahmad Faridi	Regional Tax Office, Bahawalpur	Regional Tax Office, Multan
14.	Mr. Muhammad Shafique	Regional Tax Office, Bahawalpur	Regional Tax Office, Multan
15.	Arif Javed	Regional Tax Office, Multan	Regional Tax Office, Multan
16.	Sh. Sarfraz Hussain	Regional Tax Office, Multan	Regional Tax Office, Multan
17.	Muhammad Alam Jahangir	Regional Tax Office, Multan	Regional Tax Office, Multan

S#	Name of Officers	From	To
18.	Sajid Saeed	Regional Tax Office, Multan	Regional Tax Office, Multan
19.	Muhammad Siraj	Regional Tax Office, Multan	Regional Tax Office, Multan
20.	Farooq Ahmad	Regional Tax Office, Multan	Regional Tax Office, Multan
21.	Khalid Mahmood	Regional Tax Office, Sahiwal	Regional Tax Office, Multan
22.	Naveed Ahmed	Regional Tax Office, Sahiwal	Regional Tax Office, Multan
23.	Muhammad Ahmed	Regional Tax Office, Sahiwal	Regional Tax Office, Multan
24.	Muhammad Azhar Ali Hayat	Regional Tax Office, Sahiwal	Regional Tax Office, Multan
25.	Fakhar Hayat	Regional Tax Office, Sahiwal	Regional Tax Office, Multan
26.	Ahmad Yar	Regional Tax Office, Sahiwal	Regional Tax Office, Multan
27.	Muhammad Tahir Khan Khakwani	Internal Audit (IR), Multan	Internal Audit (IR), Multan
28.	Farid Ullah	Regional Tax Office, Sahiwal	Regional Tax Office, Sahiwal
29.	Muhammad Waqar Ali	Regional Tax Office, Faisalabad	Regional Tax Office, Faisalabad
30.	Rai Shahzad Ahmed	Regional Tax Office, Faisalabad	Regional Tax Office, Faisalabad
31.	Muhammad Ilyas	Regional Tax Office, Faisalabad	Regional Tax Office, Faisalabad
32.	Abdul Majeed	Regional Tax Office, Faisalabad	Regional Tax Office, Faisalabad

S#	Name of Officers	From	To
33.	Khurshed Alam	Regional Tax Office, Faisalabad	Regional Tax Office, Faisalabad
34.	Muhammad Arshad	Regional Tax Office, Faisalabad	Regional Tax Office, Faisalabad
35.	Ali Akhtar	Regional Tax Office, Faisalabad	Regional Tax Office, Faisalabad
36.	Khalid Mehmood	Regional Tax Office, Faisalabad	Regional Tax Office, Faisalabad
37.	Ghulam Sarwar	Regional Tax Office, Faisalabad	Regional Tax Office, Faisalabad
38.	Sardar Muhammad	Regional Tax Office, Faisalabad	Regional Tax Office, Faisalabad
39.	Jehangir Ahmed	Regional Tax Office, Faisalabad	Regional Tax Office, Faisalabad
40.	Shahbaz Akhter Ranja	Regional Tax Office, Sargodha	Regional Tax Office, Sargodha
41.	Muhammad Saleem	Regional Tax Office, Sargodha	Regional Tax Office, Sargodha
42.	Saeed Ullah Khan	Regional Tax Office, Sargodha	Regional Tax Office, Sargodha
43.	Azhar Naveed Anwar	Regional Tax Office, Sargodha	Regional Tax Office, Sargodha
44.	Jafer Nazir Ranjha	Regional Tax Office, Sargodha	Regional Tax Office, Sargodha
45.	Zafar Iqbal Khan	Regional Tax Office, Sargodha	Regional Tax Office, Sargodha
46.	Usman Ghani Awan	Regional Tax Office, Sargodha	Regional Tax Office, Sargodha

2. If the above named Officers are drawing Performance Allowance prior to issuance of this notification, they shall continue to draw the same on the new place of posting.

3. They are requested to Relinquish/Assume Charge, using online HRMS facility made available at all FBR major field offices or by using IJP login.



**No. 0896-MIR-IV/2020.**—Postings/transfers of the following Inland Revenue Officers (BS-16) are made with immediate effect until further orders:-

S#	Name of Officers	From	To
1.	Maqsood Ahmed Khilji	Corporate Regional Tax Office, Lahore	Regional Tax Office-II, Lahore
2.	Ahmad Hassan	Corporate Regional Tax Office, Lahore	Regional Tax Office-II, Lahore
3.	Talat Mehmood Khan	Corporate Regional Tax Office, Lahore	Large Taxpayers Unit, Lahore
4.	Muhammad Shahid Yousaf	Corporate Regional Tax Office, Lahore	Regional Tax Office-II, Lahore
5.	Abdul Rehman	Corporate Regional Tax Office, Lahore	Corporate Regional Tax Office, Lahore
6.	Arshad Ali	Corporate Regional Tax Office, Lahore	Corporate Regional Tax Office, Lahore
7.	Muhammad Sarfraz Khan	Corporate Regional Tax Office, Lahore	Corporate Regional Tax Office, Lahore
8.	Saeed Ullah Khan	Corporate Regional Tax Office, Lahore	Regional Tax Office-II, Lahore
9.	Syed Imran Raza Zaidi	Corporate Regional Tax Office, Lahore	Corporate Regional Tax Office, Lahore
10.	Muhammad Ibrahim Malik	Regional Tax Office-II, Lahore	Regional Tax Office-II, Lahore
11.	Kabir Ahmad Butt	Corporate Regional Tax Office, Lahore	Corporate Regional Tax Office, Lahore
12.	Farhat Ali	Corporate Regional Tax Office, Lahore	Corporate Regional Tax Office, Lahore
13.	Rashid Iqbal	Corporate Regional Tax Office, Lahore	Regional Tax Office-II, Lahore
14.	S. Riaz Hussain	Regional Tax Office-II, Lahore	Regional Tax Office-II, Lahore

S#	Name of Officers	From	To
15.	Sharafat Ali	Regional Tax Office-II, Lahore	Regional Tax Office-II, Lahore
16.	Muhammad Afzal Javed	Regional Tax Office-II, Lahore	Regional Tax Office-II, Lahore
17.	Nadeem Akhtar Khan	Regional Tax Office-II, Lahore	Regional Tax Office-II, Lahore
18.	Muhammad Akmal	Regional Tax Office-II, Lahore	Regional Tax Office-II, Lahore
19.	Shahzad Ashraf	Regional Tax Office-II, Lahore	Regional Tax Office-II, Lahore
20.	Hafiz Murid Hussain	Regional Tax Office-II, Lahore	Regional Tax Office-II, Lahore
21.	Bilal Zahid	Regional Tax Office-II, Lahore	Regional Tax Office-II, Lahore
22.	Ihtasham ul Haq	Regional Tax Office-II, Lahore	Regional Tax Office-II, Lahore
23.	Muhammad Idrees	Regional Tax Office-II, Lahore	Regional Tax Office-II, Lahore
24.	Javaid Zafar Bhatti	Regional Tax Office-II, Lahore	Regional Tax Office-II, Lahore
25.	Muhammad Naveed Butt	Regional Tax Office-II, Lahore	Corporate Regional Tax Office, Lahore
26.	Haq Nawaz Bhatti	Regional Tax Office-II, Lahore	Regional Tax Office-II, Lahore
27.	Dilber Hafeez Malik	Regional Tax Office-II, Lahore	Regional Tax Office-II, Lahore
28.	Muhammad Umaar Suhail	Regional Tax Office-II, Lahore	Regional Tax Office-II, Lahore

S#	Name of Officers	From	To
29.	Muhammad Jabbar	Corporate Regional Tax Office, Lahore	Regional Tax Office-II, Lahore
30.	Ashiq Hussain	Large Taxpayers Unit, Lahore	Large Taxpayers Unit, Lahore
31.	Imran Javed Ghouri	Large Taxpayers Unit, Lahore	Large Taxpayers Unit, Lahore
32.	Gulfam Malik	Large Taxpayers Unit, Lahore	Large Taxpayers Unit, Lahore
33.	Muhammad Nadeem	Large Taxpayers Unit, Lahore	Corporate Regional Tax Office, Lahore
34.	Muhammad Nadeem	Internal Audit (IR), Lahore	Internal Audit (IR), Lahore
35.	Muhammad Safdar Malik	Internal Audit (IR), Lahore	Internal Audit (IR), Lahore
36.	Muhammad Saeed Dogar	Internal Audit (IR), Lahore	Internal Audit (IR), Lahore
37.	Syed Nasir Ali Shah	Internal Audit (IR), Lahore	Internal Audit (IR), Lahore
38.	Khawaja Messam Abbas	Internal Audit (IR), Lahore	Internal Audit (IR), Lahore
39.	Munawar Hussain	Internal Audit (IR), Lahore	Internal Audit (IR), Lahore
40.	Farina Shakeel	Data Processing Unit, Lahore	Data Processing Unit, Lahore
41.	Naveeda Yousaf	Directorate General, Training & Research (IR), Lahore	Directorate General, Training & Research (IR), Lahore
42.	Nasir Mehmood Khokhar	Regional Tax Office, Sialkot	Regional Tax Office, Sialkot

<b>S#</b>	<b>Name of Officers</b>	<b>From</b>	<b>To</b>
43.	Syed Nassar Iqbal	Regional Tax Office, Sialkot	Regional Tax Office, Sialkot
44.	Muhammad Nadeem	Regional Tax Office, Sialkot	Regional Tax Office, Sialkot
45.	Amir Aziz Mufti	Regional Tax Office, Sialkot	Regional Tax Office, Sialkot
46.	Nasir Abbas Mehdi	Regional Tax Office, Sialkot	Regional Tax Office, Sialkot
47.	Muhammad Shakoor	Regional Tax Office, Sialkot	Regional Tax Office, Sialkot
48.	Muhammad Rauf	Regional Tax Office, Sialkot	Regional Tax Office, Sialkot
49.	Saleem Ullah Shahab	Regional Tax Office, Sialkot	Regional Tax Office, Sialkot
50.	Ibrar Mohy-ud-Din	Regional Tax Office, Sialkot	Regional Tax Office, Sialkot
51.	Safdar Saleem	Regional Tax Office, Sialkot	Regional Tax Office, Sialkot
52.	Dianat Ali	Regional Tax Office, Sialkot	Regional Tax Office, Sialkot
53.	Amjad Javed	Regional Tax Office, Sialkot	Regional Tax Office, Gujranwala
54.	Muhammad Jahangir Aslam	Regional Tax Office, Sialkot	Regional Tax Office, Gujranwala
55.	Muhammad Iqbal	Regional Tax Office, Gujranwala	Regional Tax Office, Gujranwala
56.	Syed Obaid-ul-Hassan	Regional Tax Office, Gujranwala	Regional Tax Office, Gujranwala

S#	Name of Officers	From	To
57.	Arslan Rashid Khan	Regional Tax Office, Gujranwala	Regional Tax Office, Gujranwala
58.	Nasir Iqbal	Regional Tax Office, Gujranwala	Regional Tax Office, Gujranwala
59.	Daud Hussan Dar	Regional Tax Office, Gujranwala	Regional Tax Office, Gujranwala
60.	Ghazanfar Ali	Regional Tax Office, Gujranwala	Regional Tax Office, Gujranwala
61.	Muhammad Asif Iqbal Cheema	Regional Tax Office, Gujranwala	Regional Tax Office, Gujranwala
62.	Aamir Younis Khokhar	Regional Tax Office, Gujranwala	Regional Tax Office, Gujranwala
63.	Muhammad Arshad Cheema	Regional Tax Office, Gujranwala	Regional Tax Office, Gujranwala
64.	Muhammad Saleem	Regional Tax Office, Gujranwala	Regional Tax Office, Gujranwala
65.	Abdul Rehman	Regional Tax Office, Gujranwala	Regional Tax Office, Gujranwala
66.	Rana Ali Asghar	Regional Tax Office, Gujranwala	Regional Tax Office, Gujranwala
67.	Muhammad Nawaz	Inland Revenue (APP), Gujranwala	Regional Tax Office, Gujranwala

2. If the above named Officers are drawing Performance Allowance prior to issuance of this notification, they shall continue to draw the same on the new place of posting.

3. They are requested to Relinquish/Assume Charge, using online HRMS facility made available at all FBR major field offices or by using IJP login.

**No. 0893-MIR-IV/2020.**—Postings/transfers of the following Inspectors Inland Revenue (BS-16) are made with immediate effect until further orders:-

S#	Name of Officers	From	To
1.	Mr. Naeem Abbas Chandio	CRTO, Karachi	Directorate of Intelligence & Investigation (IR), Karachi
2.	Ms. Nadia Akhtar	CRTO, Karachi	Directorate of Intelligence & Investigation (IR), Karachi
3.	Mr. Muzammil Hussain	RTO-II, Karachi	Directorate of Intelligence & Investigation (IR), Karachi

2. If the above named Inspectors are drawing Performance Allowance prior to issuance of this notification, they shall continue to draw the same on the new place of posting.

3. They are requested to Relinquish/Assume Charge, using online HRMS facility made available at all FBR major field offices or by using IJP login.

**No. 0892-MIR-IV/2020.**—Postings/transfers of the following Inland Revenue Officers (BS-16) are made with immediate effect until further orders:-

S#	Name of Officers	From	To
1.	Syed Muhammad Kamal	LTU-II, Karachi	Directorate of Intelligence & Investigation (IR), Karachi
2.	Mr. Muhammad Arshad	CRTO, Karachi	Directorate of Intelligence & Investigation (IR), Karachi
3.	Mr. Abdul Jaleel Khan	RTO-II, Karachi	Directorate of Intelligence & Investigation (IR), Karachi

2. If the above named Officers are drawing Performance Allowance prior to issuance of this notification, they shall continue to draw the same on the new place of posting.

3. They are requested to Relinquish/Assume Charge, using online HRMS facility made available at all FBR major field offices or by using IJP login.

Islamabad, the 28th May, 2020

**No. 0902-IR-IV/2020.**—The competent authority has been pleased to approve the name of Mr. Mohsin Khan, Inspector-IR (BS-16), Regional Tax Office, Faisalabad who has been selected through the Internal Job Posting Process for grant of Performance Allowance with effect from 7th May, 2020.

The above named Inspector is entitled to draw Performance Allowance subject to the condition that no disciplinary proceedings/inquiry are pending against him.

The grant of Performance Allowance will be governed through the terms and conditions laid down *vide* Circular No. 6(96)S(BIC)/2013-14 dated 6th March, 2015.

**No. 0906-IR-IV/2020.**—Transfers/postings order of following Inland Revenue Officers (BS-16) made *vide* Board's Notification No. 0897-MIR-IV/2020 dated 21st May, 2020 (mentioned at S# 21, 22, 23, 24, 25 & 26) is hereby cancelled *ab-initio*:-

S#	Name of Officers	From	To
1.	Khalid Mahmood	Regional Tax Office, Sahiwal	Regional Tax Office, Multan
2.	Naveed Ahmed	Regional Tax Office, Sahiwal	Regional Tax Office, Multan
3.	Muhammad Ahmed	Regional Tax Office, Sahiwal	Regional Tax Office, Multan
4.	Muhammad Azhar Ali Hayat	Regional Tax Office, Sahiwal	Regional Tax Office, Multan
5.	Farkhar Hayat	Regional Tax Office, Sahiwal	Regional Tax Office, Multan
6.	Ahmad Yar	Regional Tax Office, Sahiwal	Regional Tax Office, Multan

MIRZA MUHAMMAD SAEED,  
Second Secretary (Mgt-IR-IV).

(Economic Affairs Division)

Islamabad, the 27th August, 2020

**No. F. 1(139)EA/Admin-II/99.**—Mr. Zahid Bashir, Stenotypist (BPS-14), Economic Affairs Division is assigned with effect from 12th August, 2020, Current charge of the post of Assistant Private Secretary (BS-16) in the office of Joint Secretary (Admin), Economic Affairs Division for a period of three months (90 days) or till the availability of regular incumbent of the post, whichever is earlier.

This issues with the approval of Secretary, Economic Affairs Division.

KHALID MAHMOOD,  
Section Officer (Admin-II).

MINISTRY OF FOREIGN AFFAIRS

Islamabad, the 19th May, 2020

**No. Estt (IV)-5/17/1982.**—Consequent upon upgradation of the post of Stenographer (BS-15) to the post of Assistant Private Secretary (BS-16), Mr. Amanatullah has been upgraded from Stenographer (BS-15) to Assistant Private Secretary (BS-16), in the Ministry, with effect from 23rd December, 2011.

MARIAM BUGTI,  
Deputy Director Estt (IV).

Islamabad, the 4th May, 2020

**No. Estt (III)-49/02/2020.**—Consequent upon recruitment by Federal Public Service Commission (FPSC) *vide* Letter No. F. 4-102/2019-R-FS-II dated 17th March, 2020 to Strategic Export Control Division (SECDIV), Ministry of Foreign Affairs, Islamabad on standard terms and conditions, Mr. Ghas Arshad, assumed charge of the post of Database Manager/IT Professional, (BS-17), at Strategic Export Control Division (SECDIV), Ministry of Foreign Affairs, Islamabad on 30th April, 2020.

**No. Estt (III)-41/16/2016.**—Consequent upon his promotion *vide* Ministry's Letter No. Estt (II)-35/2/2020 dated 29th April, 2020, Mr. Mohsin Saifullah, relinquished the charge of the post of Third Secretary (BS-17) in Embassy of Pakistan, Tehran (Iran) on 21st April, 2020 & assumed charge of the post Second Secretary (BS-18), on the same date and at the same station.

Islamabad, the 7th May, 2020

**No. Estt (III)-42/2/2008.**—In supersession of this Ministry's earlier notification of even number dated 16th April, 2020 & consequent upon his promotion *vide* Ministry's Letter No. Estt (II)-35/02/2020 dated 8th April, 2020, Mr. Muhammad Kamran Taj relinquished charge of the post of Acting Director (BPS-18) in the Ministry on 8th April, 2020 and assumed the charge of the post of

Director (BPS-19) on acting charge basis on the same date at the same station.

Islamabad, the 8th May, 2020

**No. Estt (III)-42/1/2000.**—In supersession of this Ministry's earlier notification of even number dated 16th December, 2019 and consequent upon his promotion, Mr. Muhammad Tariq Wazir, has relinquished the charge of the post of Counsellor (BS-19) in the afternoon of 30th November, 2019, and assumed the charge of the post of Minister (BPS-20) on 1st December, 2019 (FN) in the High Commission for Pakistan, Canberra.

SYEDA NAILA BATOOL,  
Assistant Director (Estt-III).

Islamabad, the 13th May, 2020

**No. Estt (I)-1/126/2006.**—Consequent upon her promotion from BS-18 to BS-19, Ms. Naheed Naveed Atif, relinquished charge of the post of Acting Director (BS-18) on 8th May, 2020 and assumed charge of the post of Director (BPS-19) on the same day in the Ministry of Foreign Affairs, Islamabad.

NAMRA AWAIS,  
Assistant Director (Estt-I).

[ORGANIZATION & CP DIRECTORATE]

Islamabad, the 18th May, 2020

**No. T&CP-1/2/2019.**—Consequent upon allocation to Foreign Service of Pakistan following probationers of 2018 Batch (47th CTP) have assumed charge as probationers (BS-17) in the Civil Service Academy on 17th October, 2019:

S. No.	Name of Probationers
1.	Aleena Humayun
2.	Shanza Faiq
3.	Yuman Azhar
4.	Anas Khan
5.	Faiza Akhtar
6.	Muhammad Ameer Hassan Butt
7.	Sadia Iqbal
8.	Shahnawaz Khan
9.	Faizan Taimoor Saqib

S. No.	Name of Probationers
10.	Kashan Saeed
11.	Zaafir Javed Ahmed
12.	Aisha Shahid Ali
13.	Alim Ullah
14.	Imran Mukhtar
15.	Syeda Fatima Hasan Bukhari
16.	Affan Waheed
17.	Aisha Shahid
18.	Muhammad Hamza
19.	Syeda Mubashra Arooj

2. This issues with the approval of the Director General (HR&CP).

**No. T&CP-1/2/2019.**—Consequent upon completion of 47th Common Training Programme, following FSP Probationers at Sr. No. 1-19 have relinquished charge as probationers (BS-17) in the Civil Services Academy and have assumed charge at Foreign Service Academy, Islamabad. They have assumed charge at Foreign Service Academy, Islamabad for 40th Specialized Training Programme on the date mentioned against each:-

S. No.	Name of Probationers	Relinquished charge at CSA	Joining Time	Period of Leave	Gazetted Holidays	Assumed charge at FSA/MOFA
1.	Aleena Humayun	21-04-2020	22nd-27th April, 2020	28th-30th April, 2020	1st-3rd May, 2020	04-05-2020
2.	Shanza Faiq	21-04-2020	22nd-27th April, 2020	28th-30th April, 2020	1st-3rd May, 2020	04-05-2020
3.	Yuman Azhar	21-04-2020	22nd-27th April, 2020	28th-30th April, 2020	1st-3rd May, 2020	04-05-2020
4.	Anas Khan	21-04-2020	22nd-27th April, 2020	28th-30th April, 2020	1st-3rd May, 2020	04-05-2020



S. No.	Name of Probationers	Relinquished charge at CSA	Joining Time	Period of Leave	Gazetted Holidays	Assumed charge at FSA/MOFA
5.	Faiza Akhtar	21-04-2020	22nd-27th April, 2020	28th-30th April, 2020	1st-3rd May, 2020	04-05-2020
6.	Muhammad Ameer Hassan Butt	21-04-2020	22nd-27th April, 2020	28th-30th April, 2020	1st-3rd May, 2020	04-05-2020
7.	Sadia Iqbal	21-04-2020	22nd-27th April, 2020	28th-30th April, 2020	1st-3rd May, 2020	04-05-2020
8.	Shahnawaz Khan	21-04-2020	22nd-27th April, 2020	28th-30th April, 2020	1st-3rd May, 2020	04-05-2020
9.	Faizan Taimoor Saqib	21-04-2020	22nd-27th April, 2020	28th-30th April, 2020	1st-3rd May, 2020	04-05-2020
10.	Kashan Saeed	21-04-2020	22nd-27th April, 2020	28th-30th April, 2020	1st-3rd May, 2020	04-05-2020
11.	Zaafir Javed Ahmed	21-04-2020	22nd-27th April, 2020	28th-30th April, 2020	1st-3rd May, 2020	04-05-2020
12.	Aisha Shahid Ali	21-04-2020	22nd-27th April, 2020	28th-30th April, 2020	1st-3rd May, 2020	04-05-2020
13.	Alim Ullah	21-04-2020	22nd-27th April, 2020	28th-30th April, 2020	1st-3rd May, 2020	04-05-2020
14.	Imran Mukhtar	21-04-2020	22nd-27th April, 2020	28th-30th April, 2020	1st-3rd May, 2020	04-05-2020
15.	Syeda Fatima Hasan Bukhari	21-04-2020	22nd-27th April, 2020	28th-30th April, 2020	1st-3rd May, 2020	04-05-2020
16.	Affan Waheed	21-04-2020	22nd-27th April, 2020	28th-30th April, 2020	1st-3rd May, 2020	04-05-2020
17.	Aisha Shahid	21-04-2020	22nd-27th April, 2020	28th-30th April, 2020	1st-3rd May, 2020	04-05-2020
18.	Muhammad Hamza	21-04-2020	22nd-27th April, 2020	28th-30th April, 2020	1st-3rd May, 2020	04-05-2020
19.	Syeda Mubashra Arooj	21-04-2020	22nd-27th April, 2020	28th-30th April, 2020	1st-3rd May, 2020	04-05-2020

2. This issues with the approval of the Director General (HR&CP).

FATIMA HAMDIA TANWEER,  
Deputy Director (Trg. & CP).

## MINISTRY OF HOUSING &amp; WORKS

Islamabad, the 20th August, 2020

**No. F. 8(21)/2020-Admn-I.**—In pursuance of Establishment Division, Islamabad's Notification No. 3-18/2018-E-2 dated 12th August, 2020 and with the approval of competent authority *i.e.* Secretary, Ministry of Housing & Works, Mr. Kashif Manzoor Malik, a BS-19 officer of Inland Revenue Service (IRS) presently posted as Deputy Secretary, Prime Minister's Office (Public), is transferred and posted as Director (BS-19), in the Federal Government Employees Housing Authority, Islamabad under Section-10 of Civil Servants Act, 1973, with immediate effect.

MUHAMMAD KAMRAN,  
Section Officer (Admn-I).

## MINISTRY OF HUMAN RIGHTS

Islamabad, the 31st August, 2020

**No. F. 344(RS)/Admn-II.**—On attaining the age of superannuation *i.e.* 60 years on 6th September, 2021, Mrs. Rahat Sultana, Principal (BS-19), Rehabilitation Centre for Children with Development Disorder (RCCDD), DGSE, Ministry of Human Rights, Islamabad shall stand retired from Government Service on 7th September, 2021.

This issues with the approval of the Secretary, Ministry of Human Rights, Islamabad.

SHAISTA AZRAR,  
Deputy Director (SE).

[NATIONAL COMMISSION FOR CHILD WELFARE AND DEVELOPMENT]

Islamabad, the 28th August, 2020

**No. PF. 1-2/2018(MA).**—With immediate from and until further orders, the postings/transfers are made on permanent basis with pay as per following details:-

S. No.	Name of the Officers	Transfer	
		From	To
1	Mr. Muddasar Altaf	Social Case Worker (BS-17), NCPD	Social Welfare Officer (BS-17), NCCWD
2.	Mr. Muhammad Awais Anjam	Social Welfare Officer (BS-17), NCCWD	Social Case Worker (BS-17), NCPD

2. This issues with the approval of the Secretary, Ministry of Human Rights, Islamabad.

HAROON-UR-RAHMAN,  
Deputy Director.

## MINISTRY OF INFORMATION AND BROADCASTING

Islamabad, the 4th August, 2020

**No. 5(6)/2020.**—On the recommendation of Departmental Promotion Committee (DPC) and with the approval of the competent authority *i.e.* Secretary, Mr. Muhammad Arshad, Assistant (BS-16), M/o. Information and Broadcasting is promoted to the post of Deputy Assistant Director (BS-16), in Audit Bureau of Circulation, M/o. Information and Broadcasting, Islamabad with effect from August 28, 2020.

On promotion, he will be on probation for a period of one year. The period may be curtailed, for good and sufficient reasons, to be recorded, or if considered necessary, it may be extended for a period not exceeding one year.

HAROON ARSHAD,  
Section Officer (E-I).

Islamabad, the 7th August, 2020

**No. 5(6)/2020-E-I.**—In pursuance of this Ministry's notification of even number dated August 4, 2020, Mr. Murad Ali, Assistant (BS-16) assumed the charge of the post of Deputy Assistant Director (BS-16) in Audit Bureau of Circulation, M/o. Information and Broadcasting, Islamabad with effect from July 23, 2020.

**No. 5(6)/2020-E-I.**—In pursuance of this Ministry's notification of even number dated August 4, 2020, Mr. Muhammad Azam, Assistant (BS-16) assumed the charge of the post of Deputy Assistant Director (BS-16) in Audit Bureau of Circulation, M/o. Information and Broadcasting, Islamabad with effect from July 23, 2020.

**No. 5(6)/2020-E-I.**—In pursuance of this Ministry's notification of even number dated August 4, 2020, Mr. Muhammad Ibrahim Soomro, Assistant (BS-16) assumed the charge of the post of Deputy Assistant Director (BS-16) in Audit Bureau of Circulation, M/o. Information and Broadcasting, Islamabad with effect from July 23, 2020.

**No. 5(6)/2020-E-I.**—In pursuance of this Ministry's notification of even number dated August 4, 2020, Mr. Muhammad Bashir, Assistant (BS-16) assumed the charge of the post of Superintendent (BS-16) in M/o. Information and Broadcasting, Islamabad with effect from July 23, 2020.

**No. 5(6)/2020-E-I.**—In pursuance of this Ministry's notification of even number dated August 4, 2020, Mr. Gul Hussain, Assistant (BS-16) assumed the charge of the post of Superintendent (BS-16) in M/o. Information and Broadcasting, Islamabad with effect from July 23, 2020.

Islamabad, the 10th August, 2020

**No. 1(19)/2018-E-I.**—Consequent upon his selection/posting to the Information Section, PAREP, Berlin, Germany, Mr. Muhammad Asif, Assistant Private Secretary (BS-16), M/o. Information and Broadcasting is relieved of his duties with effect from August 10, 2020 (AN) to join

his new assignments in the PAREP, Berlin after availing usual joining time/transit period.

MUHAMMAD SHAHID BASHIR,  
Section Officer (E-I).

[EXTERNAL PUBLICITY WING]

Islamabad, the 22nd July, 2020

**No. 1(1)/2020-EP(ISA).**—Ms. Imrana Wazir, a BS-20 Officer of the Information Group, is posted as Minister (Press) in the Information Section, High Commission of Pakistan, New Delhi, (India), in her own pay and scale, with effect from the date she will assume the charge of the above post and until further orders.

NADEEM AHMAD KHAN,  
Assistant Director (ISA).

(National Heritage & Culture Division)

Islamabad, the 22nd July, 2020

**No. F. 1(4)/2011-Admn.**—Mr. Adnan Khan, Section Officer (Heritage-I) (BS-18/OMG), National Heritage & Culture Division is granted additional charge of the vacant post of Section Officer (Heritage-II), in this Division with effect from 15th July, 2020 for a period of three months of till posting of a regular incumbent to the post whichever is earlier. He will be entitled to the financial benefit as admissible under the rules.

This issues with the approval of the PAO/Secretary, National Heritage & Culture Division.

Islamabad, the 30th July, 2020

**No. F. 1(4)/2011-Admn.**—Mr. Amanullah, Deputy Director (BS-18), National Heritage & Culture Division is granted current charge of the vacant post of Director (BS-19) with effect from 13th July, 2020 for a period of three months of till arrival of a regular incumbent whichever is earlier. He shall be allowed Special Pay at the prescribed rate per month as admissible under the rules/instruction.

This issues with the approval of the PAO/Secretary, National Heritage & Culture Division.

SHER ALAM KHAN,  
Section Officer (Admn).

Islamabad, the 20th July, 2020

**No. F. 1-14/2017-Dev(PAL-QUE).**—In supersession of this Division's notification of even number dated 11th February, 2020, Mr. Naseer-ud-Din Azar Saeed, Librarian, BPS-17, Pakistan Academy of letters, Islamabad is hereby assigned additional charge of the Project Director of the project namely "Construction of Regional Office of Pakistan Academy of Letters, Quetta" with immediate effect and until further orders with full administrative and financial

powers in accordance with the ECNEC decision dated 24th April, 2000, contained in the Guidelines for Project Management, published by the Planning Commission of Pakistan, Islamabad.

This issues with the approval of the Secretary, National History and Literary Heritage Division, Islamabad.

**No. F. 1-8/2017-Dev(PAL-PES).**—In supersession of this Division's notification of even number dated 12th March, 2020, Mr. Naseer-ud-Din Azar Saeed, Librarian, BPS-17, Pakistan Academy of letters, Islamabad is hereby assigned additional charge of the Project Director of the project namely "Construction of Office Building, Conference Room, Committee Room and Reading Room, Library, Pakistan Academy of Letters Provincial Office, Peshawar" with immediate effect and until further orders with full administrative and financial powers in accordance with the ECNEC decision dated 24th April, 2000, contained in the Guidelines for Project Management, published by the Planning Commission of Pakistan, Islamabad.

This issues with the approval of the Secretary, National History and Literary Heritage Division, Islamabad.

Islamabad, the 21st July, 2020

**No. F. 2(26)/2014-Dev-PAL.**—In supersession of this Division's notification of even number dated 12th March, 2020, Mr. Naseer-ud-Din Azar Saeed, Librarian, BPS-17, Pakistan Academy of letters, Islamabad is hereby assigned additional charge of the Project Director of the project namely "Construction of Auditorium at Pakistan Academy of letters, Islamabad" with immediate effect and until further orders with full administrative and financial powers in accordance with the ECNEC decision dated 24th April, 2000, contained in the Guidelines for Project Management, published by the Planning Commission of Pakistan, Islamabad.

This issues with the approval of the Secretary, National History and Literary Heritage Division, Islamabad.

RASHIQ AHMER,  
Archaeological Engineer.

MINISTRY OF INTERIOR

Islamabad, the 17th June, 2020

**No. 14/24/2019-ICT-I.**—In pursuance of this Ministry's notification of even number dated 5th March, 2020, Ch. Arshad Mehmood on promotion has assumed the charge of the post of Superintendent of Police (BS-18), in Islamabad Capital Territory Police, Islamabad on 20th May, 2020.

Islamabad, the 23rd June, 2020

**No. 2/68/2019-ICT-I.**—Consequent upon recommendations of the Departmental Promotion Committee (DPC) and subsequent approval by the competent authority *i.e.* Secretary Interior, Mr. Ishtiaq Ahmad Jillani, Water Management Officer (BS-17) is promoted to the post of District Officer (Water Management) (BS-18) in Water

Management Department, Islamabad Capital Territory Administration, Islamabad with immediate effect.

Islamabad, the 1st July, 2020

**No. 2/11/2019-ICT-I.**—In pursuance of the Establishment Division's Notification No. 1/286/2018-E-4, dated 21st May, 2020, Mr. Ali Sufian, a BS-18 officer of Commerce and Trade Group upon repatriation from ICT Administration, Interior Division to his parent department has relinquished the charge of the post of Director (Dev/Finance), ICTA on 1st June, 2020.

Islamabad, the 13th July, 2020

**No. 2/68/2019-ICT-I.**—In pursuance of this Ministry's notification dated 23rd June, 2020, Mr. Ishtiaq Ahmad Jillani, Water Management Officer (BS-17) has assumed the charge of the post of District Officer (Water Management) (BS-18), in Water Management Department, Islamabad Capital Territory Administration, Islamabad on 23rd June, 2020.

Islamabad, the 15th July, 2020

**No. 3/36/2019-ICT-I.**—In pursuance of the Establishment Division's Notification No. 12(45)/2014-E-3 (Police), dated 18th June, 2020, Mr. Abdul Wahab, a BS-18 officer of Police Service of Pakistan (PSP) on transfer from ICT Administration to Government of Punjab, has relinquished the charge of the post of Superintendent of Police, SSG (BS-18), ICT Police on 22nd June, 2020.

MUHAMMAD SHAFIQUE,  
Section Officer (ICT-I).

Islamabad, the 29th July, 2020

**No. 2/25/2020-ICT-I.**—In terms of Rule-4 of the Civil Servants (Directory Retirement from Services) Rules, 2020, the competent authority has been pleased to constitute the following Directory Retirement Committees to deal with the cases of the Civil Servants in BS-17 to 19 and BS-16 and below of ICT Administration under Ministry of Interior under the said Rules:-

**For the Civil Servants in BS-17 to 19**

(a)	Additional Secretary-III, Ministry of Interior	Chairperson
(b)	Representative of Establishment Division not below BS-20	Member
(c)	Representative of Finance Division not below BS-20	Member
(d)	Representative of Law and Justice Division not below BS-20	Member
(e)	Director General, ICT, Office of the Chief Commissioner, ICT, Islamabad	Member
(f)	Deputy Secretary (ICT), Ministry of Interior	Member/Secretary

**For the Civil Servants in BS-16 and below**

(a)	Joint Secretary (ICT), Ministry of Interior	Chairperson
(b)	Representative of Establishment Division not below BS-19	Member
(c)	Representative of Finance Division not below BS-19	Member
(d)	Representative of Law and Justice Division not below BS-19	Member
(e)	Director (Administration) Office of the Chief Commissioner, ICT, Islamabad	Member
(f)	Deputy Secretary (ICT), Ministry of Interior	Member/Secretary

Islamabad, the 12th August, 2020

**No. 3/49/2019-ICT-I.**—In pursuance of the Establishment Division's Notification No. F. 12(40)/2014-E-3 (Police), dated 13th July, 2020, Mr. Fazl-i-Hamid, a BS-18 officer of Police Service of Pakistan (PSP) has relinquished the charge of the post of Superintendent of Police (BS-18) in ICT Police under Ministry of Interior on 17th July, 2020.

Islamabad, the 20th August, 2020

**No. 3/28/2018-ICT-I.**—In continuation of this Ministry's notification of even number dated 6th May, 2020, the suspension period of Mr. Munawar Ali Mahar, DSP of Islamabad Capital Territory Police is hereby further extended for a period of three (03) months with effect from 30th July, 2020 to 29th October, 2020.

This issues with the approval of the competent authority.

Islamabad, the 21st August, 2020

**No. 3/23/2017-ICT-I.**—Mr. Sher Muhammad, Deputy Superintendent of Police (BS-17), ICT Police, Islamabad shall stand retired from Government Service on attaining the age of superannuation with effect from 4th September, 2020.

Islamabad, the 27th August, 2020

**No. 3/21/2020-ICT-I.**—Upon recommendation of the Departmental Promotion Committee (DPC) and subsequent approval by the competent authority *i.e.* Secretary Interior, Mr. Muhammad Manzoor, Assistant Private Secretary (BS-16) is promoted to the post of Private Secretary (BS-17) in office of IGP Islamabad with effect from 11th August, 2020.

MUHAMMAD HANZALA,  
Section Officer (ICT-I).

Islamabad, the 31st August, 2020

**No. 1/6/2020-F.Con.**—Consequent upon the approval of Ministry of Interior, Mr. Muhammad Shoaib, (PSP/BS-17), Assistant District Officer, Frontier Constabulary, Daryaba is granted ten (10) days *ex-Pakistan* leave from 3rd September, 2020 to 12th September, 2020.

ZURGHAN SHAHZAD,  
Section Officer (F. Con).

Islamabad, the 27th August, 2020

**No. 5/22/2020-Admn-I.**—In pursuance of Establishment Division's Notification No. 8/3/2019-E-VII dated 16th March, 2020, Mr. Waqas Ali Khan (BS-18/OMG) has assumed the charge of the post of Section Officer, Interior Division on 24th August, 2020.

**No. 5/22/2020-Admn-I.**—In pursuance of Establishment Division's Notification No. 8/3/2019-E-VII dated 29th January, 2020, Ms. Anam Jamal (BS-18/OMG/AC) has assumed the charge of the post of Section Officer, Interior Division on 25th August, 2020.

Islamabad, the 31st August, 2020

**No. 11(1)/2018 (Media).**—To coordinate media related issues/provision of News/Press briefing on behalf of Ministry of Interior, Mr. Zafar Abbas, Joint Secretary (FATF) has been nominated as Spokesperson for Ministry of Interior.

This issues with the approval of the Secretary Interior.

ABDUL RAZAQ,  
Section Officer (Admn-I).

Islamabad, the 28th August, 2020

**No. 5/12/2017-Admn-I.**—In pursuance of the Ministry of Interior's O.M No. 4/3/2018-Admn-I dated 17th July, 2020, Mr. Muhammad Nasir Khan, a BS-19 officer of Secretariat Group has relinquished the charge of the post of Deputy Secretary, Interior Division on 17th July, 2020.

MUHAMMAD FAYYAZ SAMI,  
Section Officer (Admn-I).

#### MINISTRY OF INTER PROVINCIAL COORDINATION

Islamabad, the 31st August, 2020

**No. F. 1-157/2010-Admn-II.**—Mr. Arshad Mehmood, APS (BS-16), presently posted with Senior Joint Secretary (Admn), M/o. IPC is allowed to hold additional charge of the vacant post of APS (BS-16) to Deputy Secretary (T&R) in addition to his own duties for a period of three months (90-days) with effect from 20th August, 2020 or till availability of regular incumbent whichever is earlier for which he would be entitled to draw additional remuneration @ 20% of basic pay subject to the maximum of Rs. 12,000/- p.m. admissible under the rules.

This issues with the approval of Senior Joint Secretary (Admn), Ministry of IPC.

MUHAMMAD MOTASIM BILLAH,  
Section Officer (Admn-II).

#### MINISTRY OF LAW AND JUSTICE

Islamabad, the 26th August, 2020

**No. F. 25(81)/2010-A-VI.**—Mr. Adnan, Assistant Private Secretary (BPS-16), Ministry of Law and Justice was

granted 90 days leave on full pay from 7th September, 2020 to 5th December, 2020.

After expiry of leave, the officer is likely to resume his duties on 7th December, 2020 (6th December, 2020 being closed holiday) at the same post and station.

ARSHAD ALI SIDDIQUI,  
Section Officer.

#### MINISTRY OF MARITIME AFFAIRS

Islamabad, the 31st August, 2020

**No. F. 12(1)/2018-KPT.**—In pursuance to the Cabinet's decision in Case No. 595/33/2020 dated 25th August, 2020, the Federal Government has been pleased to nominate Mr. Shakeel Ahmed Mangnejo, Chairman, Pakistan National Shipping Corporation (PNSC), as representative of Pakistan Ship Owners Association as a member on the Board of Trustees, KPT, for his remaining period as Chairman, PNSC *i.e.* till 3rd December, 2020.

KHIZAR SALEEM KHOKHAR,  
Deputy Secretary.

[PORTS & SHIPPING WING]

Karachi, the 29th August, 2020

**No. 17(10)/2019-Estt.**—With the approval of competent authority, Ms. Aeyman Zehra, Section Officer (Coord), Ports and Shipping Wing, Karachi is granted (07) days extension of medical leave on full pay with effect from 11th August, 2020 to 17th August, 2020.

2. Mr. Azeem Sarwar, Section Officer (P-II) shall have the look after charge of Section Officer (Coord) during the leave period of Ms. Aeyman Zehra, Section Officer (Coord) Ports & Shipping Wing, Karachi.

3. On expiry of the above leave the officer shall resume the charge on the same post and at the same station.

ALI MUHAMMAD,  
Section Officer (Estt).

#### MINISTRY OF NATIONAL FOOD SECURITY AND RESEARCH

[FEDERAL WATER MANAGEMENT CELL]

Islamabad, the 27th August, 2020

**No. F. 1-12/2019-Estt (WM).**—In pursuance of Ministry of National Food Security and Research's Notification No. 5-7/2010-Admn-I dated 26th August, 2020, Mr. Shahid Hameed Khan Khalil, Scientific Officer (BS-17) presently posted in the Federal Water Management Cell, Ministry of National Food Security and Research as Assistant Water Management Engineer (BS-17) on deputation

basis is hereby relieved from his duty with effect from 27th August, 2020 to report his parent department *i.e.* CEWRI, NARC Islamabad.

This issues with the approval of Director General, FWMC, Islamabad.

TEHMEENA IQBAL,  
Research Officer (Admn).

MINISTRY OF NATIONAL HEALTH SERVICES,  
REGULATIONS AND COORDINATION

Islamabad, the 26th August, 2020

**No. F. 3-140/2017-Estab-III.**—Dr. Shaista Naseem, Medical Officer (BS-17), working in Pakistan Institute of Medical Sciences (PIMS), Islamabad on deputation basis under wedlock policy is hereby repatriated to her parent department *i.e.* Health Department Government of Balochistan with effect from 7th September, 2019.

ZAFAR IQBAL,  
Deputy Secretary (Tech-I).

Islamabad, the 31st August, 2020

**No. F. 11(84)/2019-Admn-I.**—In pursuance of Establishment Division's O.M. No. 1-13/2017-E-2 dated 7th August, 2020 and with the approval of Additional Secretary, Ministry of National Health Services, Regulation and Coordination Mr. Saeed Ahmed, Deputy Secretary (BS-19), Ministry of Health Services, Regulations and Coordination (NHSRC) is granted Leave Preparation to Retirement (LPR) for 06 months with effect from 1st September, 2020 to 28th February, 2021.

FARHAN SIKANDAR,  
Section Officer (Admn-I).

Islamabad, the 27th August, 2020

**No. F. 6-5/2012-FMDC(E-V).**—With the approval of competent authority *i.e.* Secretary M/o. NHR&C, major penalty of "Removal from Service" has been imposed upon Dr. Maimoona Saadia, Demonstrator (BS-17), Federal Medical & Dental College Islamabad under Government Servants (Efficiency and Discipline) Rules 1973, with effect from 16th August, 2019.

Islamabad, the 28th August, 2020

**No. F. 1-4/2017-FGH-H-III.**—With the approval of competent authority *i.e.* Secretary, NHR&C, Dr. Erum Najeeb, Medical Officer (BS-17), Federal General Hospital, Islamabad, is repatriated from Federal General Poly Clinic to Federal General Hospital and relieved from Federal General Hospital with effect from 18th August, 2020 to join new assignment as Assistant Professor (BS-18) at PIMS, Islamabad, subject to completion of all codal formalities.

IMRAN ALI,  
Section Officer (Tech-IV).

Islamabad, the 26th August, 2020

**No. F. 1-618/2018-Estab-III.**—On attaining the age of superannuation, Ms. Nighat Yasmin, Nursing Instructor (BS-18), Pakistan Institute of Medical Sciences, Islamabad, shall retire from the Government Service on 1st August, 2021.

MUHAMMAD ASIF,  
Section Officer (Tech-I).

Islamabad, the 15th June, 2020

**No. F. 2-1/2018-IHRA.**—In exercise of powers conferred under section 5 (2) of the Islamabad Healthcare Regulation Act, 2018 (Act No. XXIII of 2018), the Federal Government of pleased to notify the members of the Board of the Authority, I having following composition.

S.R.#	Category	Nomination
1.	Nomination by Federal Government	Dr. Nabeela Ali
2.	Nomination by Federal Government	Director Regulation, NHS,R&C
3.	Health Professional	* Dr. Zabita Khan Shanwari * Dr. Rasia Begum Gul * Prof. Dr. Abid Zaheer Farooqi
4.	Finance & Corporate Governance	Mr. Tahir Ali Khan
5.	Legal Profession	Prof. Hafiz Aziz-ur-Rehman
6.	Philanthropist/NGO	Dr. Malik Waqar Aftab
7.	Hospital Administration	Dr. Syed Fazle Hadi

2. The above Board constituted under section 5(2) shall have function and power as laid down under section 10 of the Act.

3. A members of the Board of Authority shall hold office for the terms of three years and shall be eligible for nomination for one second term.

4. The Chairperson of the Board shall be selected from amongst its members for a term of three years.

**No. F. 2-1/2018-IHRA.**—In exercise of powers conferred under section 38 (2) of the Islamabad Healthcare Regulation Act, 2018 (Act No. XXIII of 2018), the Federal Government is pleased to notify the Budget Committee of the Authority, having following composition.

S.R#	Category	Nomination
1.	One representative each of the Authority.	Mr. Tahir Ali Khan Member of the Board under Finance and Cooperate Governance
2.	One representative of the Federal Government.	Joint Secretary (F&P), M/o. NHR&C
3.	One representative private sector nominated by the Federal Government.	Mr. Tahir Razzaque Khan

2. The budget prepared by the Authority shall be reviewed by a budget committee.

3. A budget committee shall ensure that the Authority complies with all requirements of this Act.

4. The budget committee shall take its decisions by simple majority of its members.

ZUHAIB HASSAN SHEIKH,  
Section Officer (Admn-I).

[DRUG REGULATORY AUTHORITY OF PAKISTAN]

Islamabad, the 26th August, 2020

**No. PF. 157-MA/Admn-I.**—In pursuance of Drug Regulatory Authority of Pakistan's notification of even number dated 11th August, 2020, Mst. Mahvash Ansari, Deputy Director (QC-II/FID-IV) (RO-13), Quality Assurance & Laboratory Testing Division, DRAP, Islamabad was granted 19 days leave with full pay with permission to leave the station.

After availing 19 days leave with full pay (LFP) with effect from 3rd August, 2020 to 31st August, 2020, the officer has assumed the charge with effect from 24th August, 2020 on the same post and at the same station (being public holidays on 22nd August, 2020 & 23rd August, 2020).

**No. PF. 1668-MAB/Admn-I (Vol-III).**—In pursuance of Drug Regulatory Authority of Pakistan's notification of even number dated 21st August, 2020, Mr. Manzoor Ali Bozdar, Deputy Director (RO-13), Drug Licensing Division, Drug Regulatory Authority of Pakistan, Islamabad was granted 12 days leave with full pay with effect from 10th August, 2020 to 21st August, 2020.

After availing the said leave, the officer has assumed the charge with effect from 24th August, 2020 on the same post and at the same station (being public holidays on 22nd August, 2020 & 23rd August, 2020).

**No. PF. 1668-MAB/Admn-I (Vol-III).**—In pursuance of Drug Regulatory Authority of Pakistan, Islamabad's Office Order No. F. 6-6/2011-Admn-I (Pt-II) dated 28th August, 2020, Mr. Manzoor Ali Bozdar, Deputy Director (RO-13),

DRAP, Islamabad has assumed the charge of the post of Additional Director (Licensing), Drugs Licensing Division, DRAP Islamabad with effect from 24th August, 2020 in his own pay & sciae on look after basis for a period of three (03) months.

Islamabad, the 28th August, 2020

**No. PF. 55-AA/Admn-I (Pt).**—Mr. Awais Ahmed, Assistant Director/Federal Inspector of Drugs-IX (RO-12), Drug Regulatory Authority of Pakistan, Karachi has been granted 05 days leave with full pay with effect from 20th July, 2020 to 24th July, 2020 with permission to leave the station.

2. After availing the said leave, the officer concerned has resumed his duty on 27th July, 2020 on the same post and at the same station (being public holidays on 25th July, 2020 & 26th July, 2020).

3. This issues with the approval of competent authority.

Islamabad, the 31st August, 2020

**No. PF. 1549-GRD/Admn-I (Vol-II).**—It is notified with profound grief and sorrow that Mr. Ghulam Rasool Dutani, Additional Director (BS-19), Drug Regulatory Authority of Pakistan, Ministry of National Health Services, Reuglations and Coordination was experted on 12th July, 2020. May Allah rest his soul in eternal peace and tranquility.

This issues with the approval of Secretary, Ministry of National Health Services, Regulations and Coordination.

**No. PF. 87-STHS/Admn-I (Vol-II).**—On joining of regular incumbent, Syed Tasaduq Hussain Shah promoted as Superintendent (BS-16) against the deputation vacancy on officiating basis is reverted to his original substantive post *i.e.* Assistant (BS-16) with effect from 13th July, 2020.

This issues with the approval of competent authority *vide* Ministry of National Health Services, Regulations & Coordination's Letter No. F. 3-10/2015-Admn-II/DRAP (Vol-II) dated 25th August, 2020.

**No. PF. 215-MIUH/Admn-I.**—Mr. Muhammad Ikram-Ul-Haq, Superintendent (QA & LT Division) (RO-12), Drug Regulatory Authority of Pakistan, Islamabad has been granted 09 days leave with full pay with effect from 7th September, 2020 to 15th September, 2020.

2. After expiry of the said leave, the officer concerned is expected to resume his duty on the same post and at the same station.

3. This issues with the approval of competent authority.

ULFAT RASOOL,  
Assistant Director (Admin-I).

MINISTRY OF NARCOTICS CONTROL

Islamabad, the 26th August, 2020

**No. 2-2/2003-ANF.**—In pursuance of Establishment Division's Notification No. 12(23)/88-E-3(Police) dated

10th August, 2020, Mr. Ali Zulnoorain Sheikh, a BS-21 Officer of Police Service of Pakistan has assumed the charge of the post of Deputy Director General, Anti Narcotics Force, under the Ministry of Narcotics Control with effect from 17th August, 2020.

MUHAMMAD HASSAN ABDULLAH,  
Section Officer (ANF).

Islamabad, the 31st August, 2020

**No. 7(5)/91-Admn.**—With the approval of the competent authority, the additional charge of the post of Section Officer (B&A) MNC, is assigned to Mr. Muhammad Naeem, Assistant Account Officer (AAO) BS-17, MNC, for a period of three (3) months with effect from 2nd April, 2020 to 30th June, 2020.

**No. 3-1/2003-Admn.**—In pursuance of Ministry of Narcotics Control Notification No. 1-4/2010-Admn dated 13th August, 2020, Mr. Izhar Ahmed, Assistant (BS-16) has assumed the charge of the post of Superintendent (BS-16) in Ministry of Narcotics Control, Islamabad with effect from 13th August, 2020.

This issues with the approval of the Sr. Joint Secretary, Ministry of Narcotics Control.

TAHIRA SADOZAI,  
Section Officer (Admn).

---

MINISTRY OF OVERSEAS PAKISTANIS & HUMAN  
RESOURCE DEVELOPMENT

Islamabad, the 19th August, 2020

**No. 12-5/2007-Emig-I.**—On the recommendations of Director General, Bureau of Emigration and Overseas Employment (BE&OE), Islamabad, the competent authority *i.e.* Secretary, Ministry of Overseas Pakistanis & Human Resource Development has been pleased to grant approval of 15 days R&R leave in lieu of 10 days L.F.P. with effect from 3rd August, 2020 to 17th August, 2020 to Mr. Waseem Barakullah, Director (BS-19)/P.E Rawalpindi subject to title.

**No. 9-22/2018-Emig-I.**—On the recommendations of Director General, Bureau of Emigration and Overseas Employment (BE&OE), Islamabad, the competent authority *i.e.* Secretary, Ministry of Overseas Pakistanis & Human Resource Development has been pleased to accord *ex-post facto* approval of 90 days leave with full pay (LFP). with effect from 8th June, 2020 to 6th September, 2020 to Mr. Waseem Jamal, Assistant Director (BS-17)/ Protectorate of Emigrants, Peshawar, subject to title.

**No. 9-10/2011-Emig-I.**—On the recommendations of Director General, Bureau of Emigration and Overseas Employment (BE&OE), Islamabad, the competent authority *i.e.* Secretary, Ministry of Overseas Pakistanis & Human Resource Development has been pleased to accord *ex-post facto* approval of 120 days leave with full pay (LFP). with effect from 3rd February, 2020 to 1st June, 2020 to Mr. Zaheer Ud Din, Assistant Director (BS-17),

Bureau of Emigration & Overseas Employment, Islamabad, subject to title.

**No. 9-38/2018-Emig-I.**—On the recommendations of Director General, Bureau of Emigration and Overseas Employment (BE&OE), Islamabad, the competent authority *i.e.* Secretary, Ministry of Overseas Pakistanis & Human Resource Development has been pleased to accord *ex-post facto* approval of 58 days leave with full pay (LFP). with effect from 1st March, 2020 to 27th April, 2020 to Mr. Saddarudin Sheikh, Assistant Director (BS-17), Bureau of Emigration & Overseas Employment, Islamabad, subject to title.

**No. 9-24/2018-Emig-I.**—On the recommendations of Director General, Bureau of Emigration and Overseas Employment (BE&OE), Islamabad, the competent authority *i.e.* Secretary, Ministry of Overseas Pakistanis & Human Resource Development has been pleased to accord *ex-post facto* approval of 29 days leave with full pay on medical grounds with effect from 28th May, 2020 to 25th June, 2020 to Syed Arbab Shah, Assistant Director (BS-17)/P.E Malakand, subject to title.

**No. 12-11/2007-Emig-I.**—On the recommendations of Director General, Bureau of Emigration and Overseas Employment (BE&OE), Islamabad, the competent authority *i.e.* Secretary, Ministry of Overseas Pakistanis & Human Resource Development has been pleased to accord *ex-post facto* approval of 16 days leave with full pay (LFP). with effect from 28th May, 2020 to 12th June, 2020 to Mr. Farrukh Jamal, Deputy Director (BS-18), Bureau of Emigration & Overseas Employment, Islamabad, subject to title.

**No. 12-4/2007-Emig-I.**—On the recommendations of Director General, Bureau of Emigration and Overseas Employment (BE&OE), Islamabad, the competent authority *i.e.* Secretary, Ministry of Overseas Pakistanis & Human Resource Development has been pleased to accord *ex-post facto* approval of 164 days leave with full pay (LFP). with effect from 19th February, 2020 to 31st July, 2020, Mr. Kazim Ehsan Malik, Director (BS-19) subject to title.

**No. 9-1/2016-Emig-I.**—On the recommendations of Director General, Bureau of Emigration and Overseas Employment (BE&OE), Islamabad, the competent authority *i.e.* Secretary, Ministry of Overseas Pakistanis & Human Resource Development has been pleased to accord *ex-post facto* approval of 01 day leave with full pay (LFP). with effect from 7th August, 2020 to Mr. Azad Ali Korai, Assistant Director (BS-17), Bureau of Emigration & Overseas Employment, Islamabad, subject to title.

**No. 9-26/2018-Emig-I.**—On the recommendations of Director General, Bureau of Emigration and Overseas Employment (BE&OE), Islamabad, the competent authority *i.e.* Secretary, Ministry of Overseas Pakistanis & Human Resource Development has been pleased to accord *ex-post facto* approval of 25 days leave with full pay (LFP). with effect from 23rd June, 2020 to 17th July, 2020, Syed Ijlal Hyder Shah, Assistant Director (BS-17), Bureau of Emigration & Overseas Employment, Islamabad, subject to title.

Islamabad, the 24th August, 2020

**No. 12-5/2007-Emig-I.**—On the recommendations of Director General, Bureau of Emigration and Overseas



Employment (BE&OE), Islamabad, the competent authority *i.e.* Secretary, Ministry of Overseas Pakistanis & Human Resource Development has been pleased to grant 15 days leave with full pay with effect from 18th August, 2020 to 1st September, 2020 Mr. Waseem Barakullah, Director (BS-19)/P.E Rawalpindi subject to title.

Islamabad, the 28th August, 2020

**No. 9-29/2018-Emig-I.**—Consequent upon the recommendation of Departmental Promotion Committee (DPC-I) and with the approval of the Secretary, Ministry of Overseas Pakistanis & Human Resource Development, Mr. Mansoor-ul-Hassan, Private Secretary (BS-18) is granted Time Scale Promotion from BS-18 to BS-19 as Sr. Private Secretary, Bureau of Emigration & Overseas Employment (HQs), Islamabad with immediate effect.

SHAZIA NAUREEN,  
Section Officer (Emig-I).

Islamabad, the 29th August, 2020

**No. 1(5)/2018-Admn-I.**—Mr. Saqib Ali Khan, Section Officer (BS-18), Ministry of Overseas Pakistanis and Human Resource Development has been granted 30 days leave on full pay (LFP) with effect from 30th September, 2020 to 29th October, 2020, subject to title.

This issues with the approval of the Secretary, M/o. OPs&HRD.

RAJA SHAHROZE ABBAS,  
Section Officer (Admn-I).

---

#### MINISTRY OF PARLIAMENTARY AFFAIRS

Islamabad, the 26th August, 2020

**No. F. 25(10)/2017-PA(Admn).**—After availing 32 days leave on full pay from 24th July, 2020 to 24th August, 2020, granted to him *vide* this Ministry's notification of even number dated 5th August, 2020, Mr. Abdul Ahad Sami, Section Officer (BS-18), Ministry of Parliamentary Affairs, has joined his duties on 25th August, 2020.

HAFEEZULLAH KHAN,  
Section Officer (Admn).

---

#### MINISTRY OF PLANNING, DEVELOPMENT & SPECIAL INITIATIVES

Islamabad, the 27th August, 2020

**No. 8(49)HRM.I/PDR/20.**—Consequent upon his selection by the Federal Public Service Commission and upon acceptance of terms and conditions of the post offered to him *vide* this Ministry's Memorandum No. 2 (2-11) HRM-I/ PDR/07 dated 14th July, 2020, the competent authority has been pleased to appoint Mr. Ali Farrukh as Research Officer (BS-17), Manpower Section, Ministry of Planning, Development & Special Initiatives, Islamabad with effect from 30th July, 2020 on temporary basis.

Mr. Ali Farrukh has assumed charge of the post of Research Officer (BS-17), Manpower Section, Ministry of Planning, Development & Special Initiatives on 30th July, 2020.

The officer will be on probation for a period of one year with effect from 30th July, 2020, extendable for a further period not exceeding 12 months with effect from the date of the completion of his earlier probation period.

FAIZAN ULLAH KHAN,  
Section Officer (HRM-I).

---

#### MINISTRY OF RAILWAYS

[RAILWAY BOARD]

Islamabad, the 27th August, 2020

**No. Admn-IV/19-TR/3.**—In pursuance of Chief Personnel Officer, Pakistan Railways, Headquarters Office's Notification No. 940-E/6-1-XIV (APO-V) dated 24th August, 2020, Mr. Anwar Sadaat Marwat, a BS-18 Officer of Railway (C&T) Group of Pakistan Railways, presently working as Deputy Director/T-I, Ministry of Railways, Islamabad is hereby relieved from this Ministry with immediate effect to join his new assignment as Divisional Transportation Officer, Pakistan Railways, Multan.

FAHEEM AHMED MALIK,  
Assistant Director/Admn-IV.

---

#### MINISTRY OF SCIENCE & TECHNOLOGY

Islamabad, the 26th March, 2020

**No. 3(8)/2012-Estt-II.**—In pursuance of Establishment Division's O.M No. 3/1/2019-CP-6 dated 20th March, 2020 and with the approval of Prime Minister of Pakistan being appointing authority, Mr. Ashfaq Ahmed Memon, presently working as Joint Technological Adviser (BS-20), on Acting Charge basis, is hereby promoted on regular basis to the post of Joint Technological Adviser (BS-20) with effect from 20th March, 2020.

SHAKIL ARSHAD,  
Deputy Secretary (Admn).

Islamabad, the 26th March, 2020

**No. 3(19)/2006-Estt-II.**—In pursuance of recommendations of the Departmental Selection Board (DSB) of Ministry of Science and Technology held on 19th March, 2020 and with the approval of Secretary, Ministry of Science & Technology Mr. Shakil Arshad, Assistant Scientific Adviser (BS-18) is hereby promoted as Deputy Scientific Adviser (BS-19) with effect from 19th March, 2020.

The officer shall be on probation for one year, under Rule 21 of Civil Servants (APT) Rules, 1973.

**No. 3(19)/2006-Estt-II.**—In pursuance of recommendations of the Departmental Selection Board (DSB) of Ministry of

Science and Technology held on 19th March, 2020 and with the approval of Secretary, Ministry of Science & Technology Mr. Khan Muhammad Wazir, Assistant Scientific Adviser (BS-18) is hereby promoted as Deputy Scientific Adviser (BS-19) with effect from 19th March, 2020.

The officer shall be on probation for one year, under Rule 21 of Civil Servants (APT) Rules, 1973.

MUHAMMAD HANIF AWAN,  
Deputy Secretary.

---

MINISTRY OF STATES & FRONTIER REGIONS

Islamabad, the 12th March, 2020

**No. F. 12(9)-Admn/2017.**—In pursuance of this Ministry's notification of even number dated 10th August, 2020, Ms. Nasreen Farhan Ch. Section Officer (BS-18/ deputation) has relinquished the charge of the post of Section Officer (BS-18) in the Ministry of States & Frontier Regions with immediate effect.

DR. SHAHZAD KHURSHID,  
Deputy Secretary (Admn).

---

NATIONAL ASSEMBLY SECRETARIAT

Islamabad, the 11th September, 2020

**No. T(150)/Estt.I-(143).**—Syed Jamshed Hyder Naqvi, Deputy Director (Translation) (BS-18) in the National Assembly Secretariat is granted 5 days L.F.P. with effect from 7th September, 2020 with permission to prefix closed holidays of 5th & 6th September, 2020 and suffix closed holidays of 12th & 13th September, 2020 to his leave.

On expiry of the above leave, he is expected to resume charge of the same post at Islamabad on 14th September, 2020.

**No. G(318)/Estt.I-(144).**—Mr. Nouman Tayyab Khan, Deputy Director (Reporting-English) (BS-18) in the National Assembly Secretariat is granted 22 days L.F.P. with effect from 18th September, 2020 with permission to suffix Saturday & Sunday, the 10th & 11th October, 2020.

On expiry of the above leave, he is expected to resume his duties on 12th October, 2020.

MUHAMMAD FAROOQ,  
Section Officer.

---

SENATE SECRETARIAT

Islamabad, the 9th September, 2020

**No. PA(45)/2015-HRM (132).**—In continuation of the Senate Secretariat's Notification No. PA(45)/2015-HRM

(145), dated 20th April, 2020, the competent authority has been pleased to extend the contract appointment of Mr. Asad Iqbal, Assistant Private Secretary (BPS-16) in the Senate Secretariat, Islamabad, for a further period of one year with effect from 12th September, 2020.

The other terms and conditions of his appointment will be the same as conveyed to him *vide* the Senate Secretariat's Letter No. F. 3(3)/2019-HRM, dated the 6th April, 2020.

This issues with the approval of Hon'ble Chairman Senate.

Islamabad, the 10th September, 2020

**No. M(754)/2015-HRM (133).**—The competent authority has been pleased to terminate the probation period of Mr. Sajid Rashid, Assistant Private Secretary (BS-16), Senate Secretariat, Islamabad, with effect from 5th September, 2020.

**No. PA(50)/2018-HRM (134).**—The competent authority has approved to extend the probation period of Mr. Ayub Khan, Assistant Private Secretary (BS-16), Senate Secretariat, Islamabad, for a period of six months with effect from 22nd September, 2020, under Rule 18(1) of the Senate Secretariat (Service) Rules, 2017.

Islamabad, the 14th September, 2020

**No. M(645)/2010-HRM (536).**—Mr. Asif Ali, Assistant Private Secretary (BPS-16), Senate Secretariat Islamabad is granted 12 days leave on full pay with effect from 31st August, 2020, with permission to prefix & suffix Saturdays and Sundays falling on 29th-30th August, & 12th-13th September, 2020, respectively to the leave.

After expiry of the leave, he is likely to resume his duty of the same post at Islamabad.

SADIA AMIR,  
Section Officer (HRM-II).

---

SUPREME COURT OF PAKISTAN

Islamabad, the 11th September, 2020

**No. F. 24/625/2002-SCA.**—Dr. Ijaz Ali, Sr. Court Associate (BS-19) of this Court is granted three (03) days' Leave on Full Pay with effect from 24th August, 2020 to 26th August, 2020 on account of medical grounds, subject to verification of title of his leave account by the AGPR, Islamabad.

**No. F. 24/759/2008-SCA.**—Ms. Rahila Memon, Judicial Assistant (BS-17) of this Court is granted ten (10) days' Leave on Full Pay with effect from 21st September, 2020 to 30th September, 2020 on account of private affairs, subject to verification of title of his leave account by the AGPR, Islamabad.

PERVAIZ IQBAL,  
Assistant Registrar (Admn).

## FEDERAL SHARIAT COURT

Islamabad, the 29th July, 2020

**No. F. 9(3)/2020-Admn:FSC.**—Under Rule 63 of Chapter-IX of the Federal Shariat Court (Procedure) Rules, 1981, the Hon'ble Chief Justice, Federal Shariat Court of Pakistan has been pleased to declare that 31st July, 2020 to 2nd August, 2020 (Friday to Sunday) shall be Court Holidays on the eve of Eid-ul-Azha. The Office shall re-open on Monday, the 3rd August, 2020.

GHULAM RASOOL,  
Deputy Registrar (Admn).

Islamabad, the 27th August, 2020

**No. F. 9(3)/2005-Admn:FSC.**—In pursuance of Rule-63 of Chapter-IX of the Federal Shariat Court (Procedure) Rules, 1981, the Hon'ble Chief Justice, Federal Shariat Court of Pakistan has been pleased to declare 29th and 30th August, 2020 (Saturday & Sunday) as Court

Holidays on the occasion of Ashura (9th & 10th Moharrum-ul-Haram 1442-A.H).

By Order of Hon'ble the Chief Justice.

MUHAMMAD ILYAS,  
Assistant Registrar (Admn).

## FEDERAL JUDICIAL ACADEMY

Islamabad, the 28th August, 2020

**No. 24(240)/2019-FJA.**—Pursuant to the Pak P.W.D, Islamabad Notification No. F. 3(2)/2020-Admn-III dated 3rd July, 2020, Mr. Khizar Hayat, Assistant Director (Buildings & Security) has been repatriated to his parent department *vide* Notification No. F. 24(240)/2019-FJA dated 19th August, 2020 and he is relieved to join his new assignment as Executive Engineer (Civil), with effect from 20th August, 2020 (A/N).

The officer will be paid up to and including the 19th August, 2020.

MUHAMMAD ALI,  
Director Administration.

# The Gazette of Pakistan

PUBLISHED BY AUTHORITY

KARACHI, WEDNESDAY, OCTOBER 7, 2020

## PART II

### Notifications issued by Ministry of Defence and Ministry of Defence Production

Karachi, the 7th October, 2020

MINISTRY OF DEFENCE

(Defence Division)

**No. 455/2020 :**

PA-35068 Brig. Sajid Hussain Butt has been appointed as Colonel of the Battalion of 653 S&E Unit, with effect from 2nd July, 2020.

[No. 3/1/D-2(A-II)/2020].

**No. 459/2020 :**

JSS-03403 Lt. Shabnum Niaz, AFNS has been dismissed from service, with effect from 17th July, 2020 and struck off strength from the same date.

[No. 4/8/D-2(A-II)/2020].

**No. 456/2020 :**

PSS-105947 Capt. Mubashir Ahmed, AMC has been granted Substantive / Substantive temporary promotion of Major with effect from 19th July, 2020.

[No. 3/3/D-2(A-II)/2020].

**No. 460/2020 :**

In pursuance of Establishment Division's Notification bearing No. PF.8/3/2019-E-VII, dated 16th March, 2020, Mr. Asad Naeem has relinquished the charge of the post of Section Officer (BPS-18) in Ministry of Defence on 27th July, 2020.

[No. 2/7/2015/D-26(Admin-I)].

**No. 457/2020 :**

Rear Admiral Muhammad Shuaib HI(M) (P. No. 3394), Director General Pakistan Maritime Security Agency is granted 02 days C/Leave, with effect from AM 3rd August, 2020.

[No. 5(4)/M-1/2013].

**No. 461/2020 :**

In pursuance of Finance Division's O.M. No. 19(55) Legal-II/2010-1055, dated 23rd December, 2011 read with Establishment Division's O.M. No. 1/3/2008-R-6, dated 18th August, 2015, on the recommendations of Departmental Selection Committee-I, the competent authority *i.e.* Secretary Defence Division has been pleased to grant BS-18 to Mr. Muhammad Nawaz, Private Secretary (BS-17) of Ministry of Defence, with effect from 17th February, 2018 by giving the benefits of his previous service in line with Establishment Division's O.M. No. 1/9/80-R-2, dated 2nd June, 1983.

[No. 5/1/2009/D-26(Admin-I)].

**No. 458/2020 :**

PA-45961 Maj. Mirza Asim Baig, Avn. has been dismissed from service, with effect from 15th July, 2020 and struck off strength from the same date.

[No. 4/8/D-2(A-II)/2020].

**No. 462/2020 :**

In pursuance of Finance Division's O.M. No. 19(55) Legal-II/2010-1055, dated 23rd December, 2011 read with Establishment Division's O.M. No. 1/3/2008-R-6, dated 18th August, 2015, on the recommendations of Departmental Selection Committee-I, the competent authority *i.e.* Secretary Defence Division has been pleased to grant BS-18 to Mr. Hussain Khan, Private Secretary (BS-17) of Ministry of Defence, with effect from 2nd April, 2017 by giving the benefits of his previous service in line with Establishment Division's O.M. No. 1/9/80-R-2, dated 2nd June, 1983.

[No. 5/1/2009/D-26(Admin-I)].

**No. 463/2020 :**

In pursuance of Finance Division's O.M. No. 19(55) Legal-II/2010-1055, dated 23rd December, 2011 read with Establishment Division's O.M. No. 1/3/2008-R-6, dated 18th August, 2015, on the recommendations of Departmental Selection Committee-I, the competent authority *i.e.* Secretary Defence Division has been pleased to grant BS-18 to Mr. Ghalib Mahmood, Private Secretary (BS-17) of Ministry of Defence, with effect from 12th December, 2018 by giving the benefits of his previous service in line with Establishment Division's O.M. No. 1/9/80-R-2, dated 2nd June, 1983.

He will remain posted as Senior Private Secretary to Parliamentary Secretary for Defence Division.

[No. 5/1/2009/D-26(Admin-I)].

**No. 464/2020 :**

In pursuance of Finance Division's O.M. No. 19(55) Legal-II/2010-1055, dated 23rd December, 2011 read with Establishment Division's O.M. No. 1/3/2008-R-6, dated 18th August, 2015, on the recommendations of Departmental Selection Committee-I, the competent authority *i.e.* Secretary Defence Division has been pleased to grant BS-19 as Sr. Private Secretary to Mr. Ghalib Mahmood, Private Secretary (BS-18) of Ministry of Defence, with effect from 17th December, 2019 by giving the benefits of his previous service in line with Establishment Division's O.M. No. 1/9/80-R-2, dated 2nd June, 1983.

He will remain posted as Senior Private Secretary to Parliamentary Secretary for Defence Division.

[No. 5/1/2009/D-26(Admin-I)].

**No. 465/2020 :**

In pursuance of Establishment Division's Notification bearing No. F. 7/4/2019-E-I, dated 5th August, 2020,

Air Vice Marshal Kazim Hammad Pak/10198, GD(P) has assumed the charge of the post of Additional Secretary-II, Ministry of Defence on secondment basis for a period of two years, with effect from 6th August, 2020 and until further orders.

[No. 1/3/2020/D-26 (Admin-I)].

**No. 466/2020 :**

In pursuance of Finance Division's O.M. No. 19(55) Legal-II/2010-1055, dated 23rd December, 2011 read with Establishment Division's O.M. No. 1/3/2008-R-6, dated 18th August, 2015, on the recommendations of Departmental Selection Committee-I, the competent authority *i.e.* Secretary Defence Division has been pleased to grant BS-19 as Sr. Private Secretary to Mr. Shahid Raza Shah, Private Secretary (BS-18) of Ministry of Defence, with effect from 1st March, 2020 by giving the benefits of his previous service in line with Establishment Division's O.M. No. 1/9/80-R-2, dated 2nd June, 1983.

He will remain posted as Senior Private Secretary to Additional Secretary-III for Defence Division.

[No. 5/1/2009/D-26(Admin-I)].

**No. 467/2020 :**

The Competent Authority has been pleased to approve the retirement of following General Officers from the Army with normal benefits on the date as shown against their names :-

S. No.	No., Rank and Name	Date due for Retirement
a.	PA-23703 Maj. Gen. Muhammad Ajmal Iqbal, HI(M), Engrs.	07-09-2020 (Tenure)
b.	PA-24737 Maj. Gen. Muhammad Humayun Saleem, HI(M), Arty.	10-09-2020 (Tenure)
c.	PA-24819 Maj. Gen. Abid Ejaz Kahloon, HI(M), Punjab.	07-10-2020 (Tenure)
d.	PA-24279 Maj. Gen. Iftikhar Aamir, HI(M), CMI	15-10-2020 (Extn. Tenure)

[No. 4/6/D-2(A-II)/2020].

**No. 468/2020 :**

The following Honorary Lieutenants and Subedar Majors / Subedars have been granted Honorary Commission to the rank of Honorary Captain / Lieutenant, with effect from 14th August, 2020 :-

<b><u>HONORARY CAPTAIN</u></b>				
<b>Ser. No.</b>	<b>Army No.</b>	<b>Rank</b>	<b>Name</b>	<b>Arm / Service</b>
1.	PJO-2374177	Hon. Lt.	Khalid Shah, TK-I	Punjab
2.	PJO-2588962	Hon. Lt. CSM	Zulfiqar Ali, TK-I	Baloch
3.	PJO-3324488	Hon. Lt.	Muhammad Ayub Khan, TK-I	FF
4.	PJO-3325438	Hon. Lt.	Muhammad Rashid, TK-I	FF
5.	PJO-2844691	Hon. Lt.	Sabir Hussain, TK-I	NLI
6.	PJO-3058330	H/Lt. Clk.	Muhammad Sarfraz Khan, TK-I	Arty.
7.	PJO-3059994	Hon. Lt.	Muhammad Altaf, TK-I	Arty.
8.	PJO-3065732	Hon. Lt.	Zafar Abbas, TK-I	Arty.
9.	PJO-3056468	Hon. Lt.	Chan Masood, TK-I	Arty.
10.	PJO-1705601	Hon. Lt.	Humayun, TK-I	Engrs.
11.	PJO-3643009	Hon. Lt.	Muhammad Ilyas, TK-I	Sigs
12.	PJO-3637391	Hon. Lt.	Muhammad Akram, TK-I	Sigs.
13.	PJO-3251944	Hon. Lt.	Muhammad Munir, TK-I	ASC
14.	PJO-6878459	H/Lt. SMT	Syed Naseer Abbas, TK-I	ORD.
15.	PJO-7108614	H/Lt. Clk.	Khizer Hayat, TK-I	EME
16.	PJO-7115671	Hon. Lt.	Akhtar Ali, TK-I	EME
17.	PJO-166022	Hon. Lt.	Qari Hafiz Abdul Basit Azhar Awan, TK-II	AEC

<b>HONORARY LIEUTENANT</b>				
<b>Ser. No.</b>	<b>Army No.</b>	<b>Rank</b>	<b>Name</b>	<b>Arm / Service</b>
1.	PJO-1066463	RM STENO	Nur Rehman, TK-I	AC
2.	PJO-1068861	RM	Shamshad Ul Haq, TK-I	AC
3.	PJO-2373534	SM	Muhammad Mukhtiar, TK-I	Punjab
4.	PJO-2373431	SM	Ghulam Farid, TK-I	Punjab
5.	PJO-2379424	SM	Ansar Javed, TK-I	Punjab
6.	PJO-2372608	SM	Muhammad Amin, TK-I	Punjab
7.	PJO-2369855	SM	Azhar Mehmood, TK-I	Punjab
8.	PJO-2586183	SM	Zaif Khan, TK-I	Baloch
9.	PJO-3327338	SM	Taley Muhammad, TK-I	FF
10.	PJO-3329877	SM	Fazli Qadir, TK-II	FF
11.	PJO-3332981	SUB	Fazal Muhammad, TK-I	FF
12.	PJO-3325961	SM	Tassawar Hussain, TK-I	FF
13.	PJO-3445597	SM Clk.	Farhat Ali Khan, TK-II	Sindh
14.	PJO-3447182	SM	Muhammad Azam, TK-I	Sindh
15.	PJO-3449904	SM	Jabbar Hussain, TK-I	Sindh
16.	PJO-2845991	SM	Shar Jehan, TK-I	NLI
17.	PJO-2845039	SM	Sher Babar Jan, TK-I	NLI
18.	PJO-2845237	SM	Muhammad Ali Shah, TK-II	NLI
19.	PJO-3072659	SM STENO	Amanat Abbas, TK-I	Arty.

S. No.	Army No.	Rank	Name	Arm / Service
20	PJO-3062171	SM	Muhammad Iqbal, TK-I	Arty.
21.	PJO-3075313	SM	Shoukat Hussain, TK-II	Arty.
22.	PJO-3071884	SUB	Ansar Iqbal, TK-I	Arty.
23.	PJO-3061823	SM	Zaman Sher, TK-I	Arty.
24.	PJO-3085540	SM	Jamshad Khan, TK-II	Arty.
25.	PJO-3062509	SM	Muhammad Mansha, TK-II	Arty.
26.	PJO-3066819	SM	Riaz Ullah, TK-I	AAD
27.	PJO-3064418	SM	Saeed Akhtar, TK-I	AAD
28.	PJO-3062749	SM	Muhammad Hashim, TK-I	AAD
29.	PJO-1706564	SM	Muhammad Anwar, TK-I	Engrs.
30.	PJO-1719105	SM	Maqsood Ahmad, TK-I	Engrs.
31.	PJO-1705183	SM	Israr Ahmad, TK-I	Engrs.
32.	PJO-3635741	SM	Muhammad Naseem, TK-I	Sigs.
33.	PJO-3636208	SM	Muhammad Rauf, TK-II	Sigs.
34.	PJO-3645870	SM	Abid Hussain, TK-II	Sigs.
35.	PJO-3638904	SM	Muhammad Tufail, TK-II	Sigs.
36.	PJO-3638958	SM	Abdul Rasheed Arshad, TK-II	Sigs.
37.	PJO-3638201	SM	Muhammad Aslam, TK-II	Sigs.
38.	PJO-6394511	SM	Muhammad Saeed, TK-I	ASC



S. No.	Army No.	Rank	Name	Arm / Service
39.	PJO-7344367	SM	Altaf Hussain, TK-I	AMC
40.	PJO-6878678	SM SMT	Manzoor Ali, TK-I	Ord.
41.	PJO-7111322	SUB Clk.	Muhammad Razzaq, TK-I	EME
42.	PJO-7105943	SM	Muhammad Rafique, TK-I	EME
43.	PJO-7115718	SM	Abbas Khan, TK-I	EME
44.	PJO-7119169	SM	Khawaja Muhammad Arshad, TK-I	EME
45.	PJO-7107735	SM	Gul Hassan, TK-I	EME
46.	PJO-7115357	SM	Dilshad Masih, TK-I	EME
47.	PJO-7109832	SM	Shamas Din, TK-I	EME
48.	PJO-7124571	SM	Muhammad Zareen, TK-I	EME
49.	PJO-50804	SM	Syed Abrar Hussain, TK-I	AEC
50.	PJO-7763848	SM Clk.	Saif Ur Rehman, TK-I	CMP
51.	PJO-7763962	SM	Khadim Hussain, TK-I	CMP
52.	PJO-8828694	SM	Tariq Mehmood, TK-II	DSF
53.	PJO-8829591	SM	Muhammad Akram Khan, TK-II	DSF
54.	MJ-480821	SM	Zafar Iqbal, TK-I	MJD

[No. F.5/1/D-2(A-II)/2020].

MIAN MUHAMMAD HILAL HUSSAIN, *HI(M)*, *Lt. Gen. (Retd.)*,  
Secretary.

## MINISTRY OF DEFENCE PRODUCTION

[AVIONICS PRODUCTION FACTORY, PAKISTAN AERONAUTICAL COMPLEX BOARD]

**No. 469/2020 :**

In exercise of the power conferred by clauses (2) and (3) of rule 2 of the Government Servants (Efficiency & Discipline) Rules 1973, the undersigned being Competent Authority hereby designate Deputy Managing Director (Sensors) as "Authorized Officer" in respect of the Government Servants holding posts in BPS-3 to BPS-15 or equivalent at APF, PAC, Kamra.

[No. APF/1860/9/PC].

ARIF SALEEM, *Air Commodore*,  
Managing Director.

**No. 470/2020 :**

The Chairman PAC Board, Kamra (Competent Authority) has been pleased to accord approval for retirement from service in respect of E-80008, Mr. Muhammad Afzal, Deputy Chief Engineer (Production Control), BPS-19, with effect from 14th February, 2019 (AN) on attaining the age of superannuation. The officer has been SOS of the establishment / strength of this factory with effect from 15th February, 2019 (FN).

[No. APF/JF-17/2101/9/PC].

**No. 471/2020 :**

The Managing Director (Competent Authority) Avionics Production Factory, Pakistan Aeronautical Complex, Kamra has been pleased to accord approval for retirement from service in respect of the under mentioned officials of APF (JF-17) on attaining the age of superannuation, with effect from the dates as mentioned against their names :-

S. No.	Svc. No.	Name	Designation	BPS	Date of retirement from service	Date of Struck of Strength
(a)	T/60052	Mr. Shahadat Hussain	PFM/Radio Fitter	16	23-10-2018 (AN)	24-10-2018 (FN)
(b)	T/60033	Mr. Muhamamd Javed	PFM/Radio Fitter	16	27-11-2018 (AN)	28-11-2018 (FN)
(c)	T/60212	Mr. M. Ayub Abid	PFM/Radar Fitter	16	02-03-2019 (AN)	03-03-2019 (FN)
(d)	T/60105	Mr. Khalid Farooq	PFM/Radar Fitter	16	14-03-2019 (AN)	15-03-2019 (FN)

[No. APF/JF-17/2101/9/PC].

**No. 472/2020 :**

Chairman JF-17 Board of Directors (Competent Authority) has been pleased to accord approval for extension in the contractual appointment of JF-17/CE-90014 Air Cdre (Retd.) Mr. Muhammad Younas against M-III Scale vacancy at APF (JF-17), PAC Kamra for a further period of one year from 4th October, 2019 to 3rd October, 2020.

[No. APF/JF-17/2101/9/PC].

**No. 473/2020 :**

Chairman JF-17 Board of Directors (Competent Authority) has been pleased to accord approval for extension in the contractual appointment of JF-17/CE-90015 Dr. Bilal Ahmed Siddiqui S/o Tauqeer ul Islam against M-III Scale vacancy at APF (JF-17), PAC Kamra for a further period of one year from 24th December, 2019 to 23rd December, 2020.

[No. APF/JF-17/2101/9/PC].

**No. 474/2020 :**

The Competent Authority (Chairman PAC Board) has been pleased to approve the promotions of the under mentioned civilian officials of Avionics Production Factory (JF-17 Project), PAC Board Kamra to the next higher posts and BPS as stated against their names with effect from 9th September, 2019 :-

S. No.	Svc. No. & Name	Present Rank / BPS	Rank / BPS to which promoted
(a)	JF-17/T-60382 Mr. Abdul Khanan	FM (Radar Fitter) BPS-15	PFM (Radar Fitter) BPS-16
(b)	JF-17/T-60313 Mr. Saqib Ali	FM (Radar Fitter) BPS-15	PFM (Radar Fitter) BPS-16
(c)	JF-17/T-60285 Mr. Muhammad Jawad	FM (Radio Fitter) BPS-15	PFM (Radio Fitter) BPS-16
(d)	JF-17/T-60053 Mr. Saeed Akhtar	FM (Radio Fitter) BPS-15	PFM (Radio Fitter) BPS-16

2. They will be on probation for a period of one year which is extendable for further period not exceeding one year.

[No. APF/JF-17/2109/1/PC].

**No. 475/2020 :**

Consequent upon the approval of the Competent Authority (Chairman PAC Board, Kamra) has been pleased to appoint Mr. Muhammad Waqas Ahmed S/o. Hidayat Ullah as Program Manager (Rig. Software Design) in BPS-18 on contract for a period of one year, with effect from 14th January, 2020 (FN) against an establishment vacancy of Avionics Production Factory (JF-17 Project), PAC Kamra.

[No. APF/JF-17/2101/9/PC].

**No. 476/2020 :**

Consequent upon the approval of the Competent Authority (Chairman PAC Board, Kamra) Mr. Liaqat Ali S/o Ameer Hamza has been appointed as Deputy Program Manager (Soldering) in BPS-17 on contract for a period of two years, with effect from 28th April, 2020 (FN) against an establishment vacancy of JF-17 Project at Avionics Production Factory, PAC Kamra.

[No. APF/JF-17/2101/9/PC].

**No. 477/2020 :**

The Competent Authority (Chairman PAC Board) has been pleased to approve the promotion of A-1311, Mr. Zahoor Ahmad Khan, Store Supervisor (BPS-16) to the post of Assistant Director Logistic in BPS-17, with effect from 4th May, 2020 (FN). Certified that the officer has assumed the charge of the post, with effect from the same date.

The officer will be on probation for a period of one year which is extendable for further period not exceeding one year.

[No. APF/1860/9/PC].

**No. 478/2020 :**

The Competent Authority (Chairman PAC Board) has been pleased to approve the promotion of A-30290, Mr. Ali Akbar, Storekeeper (BPS-16) to the post of Assistant Director Logistic in BPS-17, with effect from 4th May, 2020 (FN). Certified that the officer has assumed the charge of the post, with effect from the same date.

The officer will be on probation for a period of one year which is extendable for further period not exceeding one year.

[No. APF/JF-17/2109/1-PC].

MUSHTAQ AHMAD,  
Director HRM.

# The Gazette of Pakistan

PUBLISHED BY AUTHORITY

KARACHI, WEDNESDAY, OCTOBER 7, 2020

## PART III

Notifications issued by the High Courts, the Federal Public Service Commission and by the Attached and Subordinate Offices of the Government of Pakistan

FEDERAL PUBLIC SERVICE COMMISSION

Islamabad, the 30th July, 2020

**No. F.2-3/2007-HR-I.**—With the approval of Competent Authority, Mr. Kamran Raffat, has assumed the charge of office of the Deputy Director (BS-18), FPSC on 13th July, 2020 after completion of 29th Mid-Career Management Course (MCMC) at National Institute of Management, Quetta.

The Officer is entitled to qualification pay as per rules.

Islamabad, the 4th August, 2020

**No. F.19-60/78-Estt.(Vol-II).**—With the approval of Competent Authority, Mr. Muhammad Rafiq, Senior Private Secretary (BS-19) is allowed encashment of leave preparatory to retirement (LPR) of 365 days with effect from 24th December, 2019.

On attaining the age of superannuation on 23rd December, 2020, he will stand retired from Government Service with effect from 24th December, 2020.

FAIQ AHMAD KHAN,  
Assistant Director (HR-I).

APPELLATE TRIBUNAL INLAND REVENUE

(Headquarters)

Islamabad, the 3rd August, 2020

**No. F.1-ATP/HQ/(Ad)/2020.**—It is hereby notified with deep sorrow that Mr. Adnan UI Haq, Assistant Private Secretary (BS-16), Appellate Tribunal Inland Revenue, Bench-VIII, Lahore died during service on 30th June, 2020.

Mr. Adnan UI Haq was working as APS in ATIR, Lahore. His behaviour and attitude towards his colleagues and general public was excellent and co-operative. He performed his duties to the satisfaction of his seniors. His services will be remembered forever as for good. May Allah rest his soul in eternal peace.

His name has been struck off from the strength of Appellate Tribunal Inland Revenue, (ATIR) Bench-VIII, Lahore.

**No. F.1-ATP/HQ/(Ad)/2020.**—Pursuant to this office notification of even number, dated 24th June, 2020, Mr. Muhammad Irfan Khan has relinquished the charge of the post of Assistant Registrar (BS-16) Appellate Tribunal Inland Revenue, Bench-VII Karachi on 24th June, 2020 (Afternoon).

Mr. Muhammad Irfan Khan has assumed the charge of the post of Assistant Registrar (BS-16) Appellate Tribunal Inland Revenue, Peshawar Bench, Peshawar, on 26th June, 2020 (forenoon).

**No. F.1-ATP/HQ/(Ad)/2020.**—With the approval of the Hon'ble Chairman, ATIR, Mr. Muhammad Irfan Khan, Assistant Registrar (BS-16) Appellate Tribunal Inland Revenue, Peshawar Bench, Peshawar has been granted 50-days leave on full pay with effect from 24th July, 2020 to 11th September, 2020 with permission to leave the station.

Mr. Muhammad Irfan Khan has relinquished the charge of the post of Assistant Registrar (BS-16) Appellate Tribunal Inland Revenue, Peshawar Bench, Peshawar, on 23rd July, 2020 (Afternoon).

Islamabad, the 4th August, 2020

**No. F.1-ATP/HQ/(Ad)/2020.**—With the approval of the Hon'ble Chairman, ATIR, Mrs. Shaher Bano Walajahi, Accountant Member (BS-21) Appellate Tribunal Inland Revenue, Karachi has been granted 19-days leave on full pay with effect from 10th August, 2020 to 28th August, 2020.

Islamabad, the 7th August, 2020

**No. F.1-ATP/HQ/(Ad)/2020.**—Pursuant to this office notifications of even number, dated 1st July, 2020 & 14th July, 2020, Mrs. Farhat Yasmeen has relinquished the charge of the post of Private Secretary (BS-18) Appellate Tribunal Inland Revenue, Lahore, on 5th June, 2020 (afternoon).

Mrs. Farhat Yasmeen has assumed the charge of the post of Private Secretary (BS-18) Appellate Tribunal Inland Revenue, Lahore on 15th July, 2020 (Forenoon).

ABDUL RASHEED UJJAN,  
Assistant Registrar (Admn.).

---

BUREAU OF EMIGRATION AND OVERSEAS  
EMPLOYMENT

Islamabad, the 3rd August, 2020

**No. BE(Admn-Estt)1(42)/2018/3565.**—In pursuance of the Cabinet Secretariat, Establishment Division, Government of Pakistan, Notification No.6/1/2007-D-2 dated 30th July, 2020, office timings shall be observed from 09:00 am to 05:00 pm (Monday to Friday) in Bureau of Emigration & Overseas Employment (HQs) & Protectorate of Emigrants offices with effect from 3rd August, 2020.

This issues with the approval of Director General (BE & OE).

Islamabad, the 4th August, 2020

**No. BE(Admn-Estt)2(483)/2007/2020/3578.**—Consequent upon his transfer from Protectorate of Emigrants, Peshawar to Bureau of Emigration & Overseas Employment (HQ), Islamabad *vide* Ministry of Overseas Pakistanis & Human Resource Development Notification No.10-2/2011-Emig-I/87/Vol-IV dated 14th April, 2020, Mr. Kazim Ehsan Malik relinquished the charge of the post of Director /PE (BS-19) Protectorate of Emigrants, Peshawar on 20th April, 2020 and assumed charge of the post of Director (BS-19) at Bureau of Emigration & Overseas Employment (HQ), Islamabad with effect from 3rd August, 2020 after availing medical leave.

This issues with the approval of Director General (BEOE).

MUHAMMAD ISRAR,  
Assistant Director (Estt.).

COLLECTORATE OF CUSTOMS  
(ADJUDICATION-II)

Karachi, the 4th August, 2020

**No. 1016-C-II/2020.**—In pursuance of Board's Notification No.1016-C-II/2020 dated 30th July, 2020, Mr. Ghulam Hyder Mahesar, Deputy Collector, (BS-18), an officer of Pakistan Custom Service has assumed the charge of the post of Deputy Collector (BS-19), Collectorate of Customs (Adjudication-II), Custom House, Karachi on 30th July, 2020.

MUHAMMAD IQBAL BHAWANA,  
Collector.

---

DIRECTORATE GENERAL OF IMMIGRATION  
& PASSPORTS

Islamabad, the 4th August, 2020

**No. 21/01/2020-Admn-I.**—In pursuance of Establishment Division, Cabinet Secretariat Notification No.PF(857)/E-5(PAS) dated 29th July, 2020, Dr. Naeem Rauf, a BS-20 officer of Pakistan Administrative Service has assumed the charge of the post of Director General in Directorate General Immigration & Passports, Headquarters, Islamabad on 30th July, 2020.

This issues with the approval of Director General, Immigration & Passports.

Islamabad, the 7th August, 2020

**No. F.02/01/2017-Admn.**—In pursuance of Ministry of Interior Letter No.6/2/2020-Estt (I&P) dated 5th August, 2020 Mr. Fiaz Hussain, Director (CZ), Immigration and Passports, Lahore is hereby placed under suspension with effect from 5th August, 2020 till finalization of disciplinary proceedings.

This issues with the approval of Director General Immigration & Passports.

WIQAR ALI,  
Assistant Director (Admn-I).

---

FEDERAL GENERAL HOSPITAL

Islamabad, the 16th June, 2020

**No. PF/354/AA/CN/ADMN/2017.**—With the approval of competent authority, Ms. Amna Akbar, Charge Nurse (BS-16), Federal General Hospital, Ministry of National Health Services Regulation and Coordination, Islamabad has been granted 90 days Maternity leave with full pay with effect from 25th May, 2020 to 22nd August, 2020.

After expiry of the leave, the officer concerned will assume her duty on 23rd August, 2020 on the same post at the same station.

**No. PF/95/WS/ADMN-FGH.**—With the approval of competent authority, Mr. Wakeel Shah, Charge Nurse (BS-16), Federal General Hospital, Ministry of National Health Services Regulation and Coordination, Islamabad has been granted 14 days leave with full pay with effect from 8th June, 2020 to 21st June, 2020.

After expiry of the leave, the officer concerned will assume his duty on 22nd June, 2020 on the same post at the same station.

**No. PF/308/Pharmacist/FGH.**—With the approval of competent authority, Dr. Ayesha Inam, Pharmacist (BS-17), Federal General Hospital, Ministry of National Health Services Regulation and Coordination, Islamabad has been granted 13 days leave with full pay with effect from 8th June, 2020 to 20th June, 2020.

After expiry of the leave, officer concerned will assume her duty on 21st June, 2020 on the same post at the same station.

Islamabad, the 21st July, 2020

**No. PF/92/KI/ADMN/FGH.**—With the approval of competent authority, Mr. Khurram Ishaq, Charge Nurse (BS-16), Federal General Hospital, Ministry of National Health Services Regulation and Coordination, Islamabad has been granted 10 days leave with full pay with effect from 2nd July, 2020 to 11th July, 2020.

After expiry of the leave, the officer concerned will assume his duty on 11th July, 2020 on the same post at the same station.

**No. PF/356/VNB/ADMN/FGH.**—With the approval of competent authority, Mr. Victor Nazir Bhatti, Charge Nurse (BS-16), Federal General Hospital, Ministry of National Health Services Regulation and Coordination, Islamabad has been granted 14 days leave with full pay with effect from 2nd July, 2020 to 14th July, 2020.

After expiry of the leave, the officer concerned will assume his duty on 15th July, 2020 on the same post at the same station.

MUHAMMAD UMAR ASHRAF,  
Superintendent (Admn).

FEDERAL GOVERNMENT EMPLOYEES HOUSING  
AUTHORITY

Islamabad, the 6th August, 2020

**No. F.2(3)/2020-Rec-HA(A).**—The competent authority *i.e.* Secretary Housing & Works is pleased to constitute the following Selection Committee in FGE Housing Authority

to recommend the candidates applied against Technical Post from PPS-05 to PPS-06:-

- |      |  |          |
|------|--|----------|
| i.   | Director General, FGE<br>Housing Authority   | Chairman |
| ii.  | Director Technical, FGE<br>Housing Authority | Member   |
| iii. | Director Staff, FGE<br>Housing Authority     | Member   |

**No. F.2(3)/2020-Rec-HA(A).**—The competent authority *i.e.* Secretary Housing & Works is pleased to constitute the following Selection Committee in FGE Housing Authority to recommend the candidates applied against Technical Posts from PPS-07 to PPS-09.

- |      |   |          |
|------|---|----------|
| i.   | Additional Secretary,<br>M/o. Housing & Works | Chairman |
| ii.  | Managing Director,<br>PHA Foundation          | Member   |
| iii. | Director General, FGE<br>Housing Authority    | Member   |

MALIK ALI ABBAS,  
Deputy Assistant Director.

GENERAL HEADQUARTERS FGEI, (C/G)  
DIRECTORATE

(IGT & E's Branch)

Rawalpindi, the 23rd July, 2020

**No. 04/PF-735/77-FGEI (SA).**—Consequent upon his request for grant of premature retirement from Government Service on completion of 30 years qualifying service for pension, Mr. Tahir Kamran Kiani, Librarian, FG Public School (2nd Shift) CMT & SD Golra Rawalpindi Cantt is hereby granted encashment in lieu of LPR for 269 days with effect from 1st January, 2020 to 25th September, 2020 in accordance with Finance Division O.M. No.F.1(7)R-4/2004 dated 29th August, 2012.

Certified that 269 days leave on full pay is due at his credit as verified by PAO.

He will stand retired from Government Service and his name will be struck off the strength of said school with effect from 25th September, 2020 (Afternoon).

ANWAR HUSSAIN, *Brig.*,  
For Director General.

Rawalpindi, the 21st July, 2020

**No. 04/PF-08/77-FGEI (M).**—On completion of 30 years qualifying service Saleem Ahmed, Vice Principal (BPS-18), FG Public School (Boys) Peshawar Road Rawalpindi Cantt., is hereby granted 365 days encashment in lieu of LPR with effect from 6th January, 2020 to 4th January, 2021 in accordance with Finance Division OM No.F.1(7) R-4/2004 dated 29th August, 2012.

Certified that 365 days leave on full pay stands at his credit.

He will be retired from Government services and his name will be struck off the strength of school with effect from 4th January, 2021 (Afternoon).

Rawalpindi, the 23rd July, 2020

**No. 04/PF-1901/77-FGEI (SA).**—Having exercised the option not to avail LPR on attaining the age of superannuation i.e. 60 years on 7th August, 2020, Mrs. Shamim Akhtar, TGT, FG Public School (Girls) Bahawalpur Cantt. is hereby granted 233 days Encashment of LPR with effect from 19th December, 2019 to 7th August, 2020 in accordance with Finance Division's O.M. No.F(1(7) R-4/2004 dated 29th August, 2012.

Certified that 233 days leave on full pay stands at her credit as verified by PAO.

She will stand retired from Government service and her name will be struck off the strength of said school with effect from 7th August, 2020 (Afternoon).

**No. 04/PF-772/77-FGEI (SA).**—Mst. Rizwana Iqbal, TGT, FG Public School No.3 (Girls) 2nd Shift Multan Cantt. is hereby granted special/ iddat leave on full pay for 130 days with effect from 1st May, 2020 to 7th September, 2020.

On expiry of above leave, she is expected to resume her duty in the same school at Multan Cantt.

Rawalpindi, the 29th July, 2020

**No. 04/PF-730/77-FGEI (SA).**—Mrs. Safia Nasir, TGT, FG Public School No.3 (Girls) STC Kohat Cantt. is hereby granted 45 days post-confinement maternity leave on full pay with effect from 15th April, 2020 to 29th May, 2020.

**No. 04/PF-139/77-FGEI (SA).**—Mrs. Humaira Jamal, TGT, FG Junior Public School Mehfooz Road Rawalpindi Cantt. is hereby granted 45 days pre-confinement maternity leave on full pay with effect from 4th July, 2020 to 17th August, 2020.

On expiry of above leave, she will proceed on post-confinement maternity leave.

**No. 04/PF-886/77-FGEI (SA).**—Mrs. Misbah Jamil, Librarian, FG Fazaia Public School (2nd Shift) PAF Base Nur Khan Rawalpindi is hereby granted 365 days ex-Pakistan leave as EOL without pay with effect from 1st August, 2020 to 31st July, 2021 and this Directorate has no objection for proceeding her abroad (Turkey) for private visit during this period, subject to the condition that no foreign exchange will be involved on the part of Government of Pakistan on any account.

No further extension will be granted after expiry of ex-Pakistan leave.

AGHA JAVED AKBAR KHAN, *Lt. Col.*  
For Director General.

Rawalpindi, the 28th July, 2020

**No. 0409/7-Prom-/77-FGEIs (NTS).**—In pursuance of Ministry of Defence Notification No.2/14/D-22/2008-II dated 22nd July, 2020, the services of the following three Superintendents (BS-16) of Federal Government Educational Institutions (Cantts/ Garrisons) who were promoted as Administrative Officers (BS-17) on Acting Charges Basis in the meeting held on 5th September, 2018, are hereby regularized as Administrative Officers (BS-17), with effect from 22nd July, 2020:-

Ser.	Name & Office /Institution
a.	Mr. Abdul Majeed, FGEIs (C/G) Dte. Rawalpindi
b.	Shafiq Ahmed, FG Degree College for Boys, Multan Cantt.
c.	Mr. Nizam -ud-Din, FG Degree College for Girls, Nowshera Cantt.

2. They will remain on probation for a period of one year during which no request for posting/ attachment will be entertained.

**No. 0409/7-Prom/77-FGEIs (NTS).**—In pursuance of Ministry of Defece Notification No.2/14/D-22/2008-I, dated 22nd July, 2020, following superintendents (BS-16) of Federal Government Educational Institutions (Cantts/ Garrisons) are hereby given Acting Charge appointment as

Administrative Officers (BS-17) with effect from 22nd July, 2020 and posted/ adjusted to the offices/ institutions as mentioned against each:-

Ser.	Name & Office / Institution	Posted to	Remarks
a.	Mr. Tariq Mahmood FGEIs (C/G) Dte. Rawalpindi Cantt.	FGEIs (C/G) Dte., Rawalpindi Cantt.	Against an existing vacancy Promoted on Acting Charge Basis
b.	Amir Shehzad FGEIs (C/G) Dte. Rawalpindi Cantt.	FGEIs (C/G) Dte. Rawalpindi Cantt.	Against an existing vacancy Promoted on Acting Charge Basis
c.	Syed Tahir Ali Shah, FG Degree College for (Girls), Quetta	FG Degree College for (Girls), Quetta Cantt.	Already working against the post of Admin Officer (BS-17) Promoted on Acting Charge basis subject to the cancellation of his LPR/ re-joining in FGEI (C/G).
d.	Mian Khalid Rasool FGEIs (C/G) Regional Office, Kharian	FG Degree College for (Boys) Nowshera	Against an existing vacancy Promoted on Acting Charge Basis
e.	Mr. Ayaz Mahmood, FGEIs (C/G) Dte. Rawalpindi Cantt.	FGEIs (C/G) Dte. Rawalpindi Cantt.	Against an existing vacancy Promoted on Acting Charge Basis
f.	Altaf Hussain FGEIs (C/G) Dte. Rawalpindi Cantt.	FGEIs (C/G) Dte. Rawalpindi Cantt.	Against an existing vacancy Promoted on Acting Charge Basis
g.	Syed Touqeer Abbas FGEIs (C/G) Dte. Rawalpindi Cantt.	FGEIs (C/G) Dte., Rawalpindi Cantt.	Already working against the post of Admin. Officer (BS-17) Promoted on Acting Charge Basis w.e.f. 15-09-2020.

2. They will remain on probation for a period of one year during which no request for posting / attachment will be entertained.

3. No TA / DA will be paid.

4. Representation against posting will be entertained from the individuals after joining new place of posting.

NADEEM KHALID, Lt. Col.,  
For Director General.

Rawalpindi, the 20th July, 2020

**No. PF-06/Gen/2016-FGEI (CA).**—Consequent upon her repatriation to parent department *i.e.* Fatima Jinnah Government Degree College Gilgit (under Government of Gilgit Baltistan), Mrs. Surraiya Bano, Lecturer in Political Science (BPS-17) working on deputation at FG Degree College, Lahore Cantt. (under FGEIs setup) made *vide* this Directorate Letter No.04/Tfr/77-FGEI(CM) dated 18th March, 2020 has been relieved off her duties with effect from 18th March, 2020 (A.N) to join her parent department.

**No. 04/PF-2347/16-FGEI (CA).**—Consequent upon her repatriation to parent department *i.e.* Higher Education Department, Government of the AJ& K, Muzaffarabad (Government Girls Degree College, Abbaspur, District Poonch, AJ&K) working on deputation (with effect from 11th January, 2016 to 24th March, 2020) under FGEIs C/G Directorate, Sir Syed Road, Rawalpindi, Mrs. Farzana Shaheen, Assistant Professor of History (BPS-18) has been relieved of her duty on 24th March, 2020.

Rawalpindi, the 22nd July, 2020

**No. 04/PF-1556/03-FGEI (CA).**—Consequent upon her appointment/selection as Associate Professor of Chemistry (BPS-19) in Government Prostrgraduate College, Timergara, Lower Dir (KPK) (under Government of KPK) *vide* offer of appointment Letter No.SO(C-1)/HE/1-13/KP-PSC/Male Urdu/2020 dated 21st May, 2020, Mr. Muhammad Ishaq, Assistant Professor (BPS-18), FG Degree College for Boys, Nowshera Cantt. has been relieved on 29th May, 2020 (AN).

**No. 04/PF-110/07-FGEI (CA).**—Consequent upon her appointment/selection as Assistant Professor of History-Cum-Civics (BPS-18) in Government Degree College No. 2, Mardan (under Government of KPK) *vide* offer of appointment Letter No.SO(C-II)/HED/2-5/2019/Male Histort-Cum-Civics dated 15th June, 2020, Mr. Noor Ullah Khan, Lecturer in Political Science (BPS-17), FG Degree College for Boys, Nowshera Cantt. has been relieved on 30th June, 2020 (AN).



Rawalpindi, the 23rd July, 2020

**No. 04/PF-76/86-FGEI (CA).**—Having exercised her option not to avail LPR on attaining the age of superannuation on 12th March, 2021 (Afternoon), Mrs. Rubina Zaheer Assoc Prof (BPS-19), FG Degree College, Lahore Cantt. is hereby granted Encashment of LPR for 181 days from 13th September, 2020 to 12th March, 2021 in accordance with Finance Division's O.M. F. 1(ii)-IMP/83 dated 18th August, 1983 & SRO (I)/2012 dated 29th August, 2012.

Certified that 181 days leave on full pay stands at her credit as verified by the Audit Office.

On expiry of encashment period, she will stand retired from Government Service and her name will be struck off the strength of said institution with effect from 12th March, 2021 (AN).

Rawalpindi, the 27th July, 2020

**No. 04/PF-1942/10-FGEI (CA).**—Mrs. Nazish Noor, Lecturer in Statistics (BPS-17) FG Girls Degree College, Quetta Cantt, is hereby granted 30 days ex-Pakistan leave on half average pay (HAP) with effect from 30th July, 2020 to 28th August, 2020 on private affairs.

On expiry of above leave, she is expected to resume duty at Quetta.

**No. 04/PF-1405/97-FGEI (CA).**—Having been declared completely and permanently incapacitated/Unfit for further Government Service (showing eighty Five percent (85%) degree of disability) by Directorate of Central Health Establishment Ministry of National Health Services, Regulations & Coordination NIRM Islamabad (*vide* their Letter No. F. 2-9/2020/I-R/CMB/113 dated 13th February, 2020). Mr. Abdul Rauf Associate Professor of Islamiyat (BPS-19) FG Degree College, PAC Kamra Cantt. is hereby retired from Government Service on Medical Grounds with effect from 16th July, 2020.

This is issued with the approval of competent authority *i.e.* Secretary Defence conveyed *vide* U.O. No. 10/1/D-22/2020, dated 16th July, 2020.

Rawalpindi, the 29th July, 2020

**No. 04/PF-6-Gen-2020-FGEI (CA).**—Consequent upon her selection as Lecturer in English (BPS-17) through FPSC made *vide* this Directorate Letter No. 0409/Lec-M-20-FGEI (CM), dated 21st May, 2020, Ms. Sara Noor, Lecturer (BPS-17) has assumed the charge of the post of Lecturer (BPS-17) at FG Degree College, Attock Cantt. on 1st June, 2020 (forenoon).

She will be on probation for a period one year with effect from 1st June, 2020.

**No. 04/PF-1659/03-FGEI (CA).**—Consequent upon his selection as Associate Professor of Urdu (BPS-19) through KPPSC under Higher Education, Archives & Libraries Department (Civil Secretariat) (at Government Degree College, Kulachi, D.I. Khan, KPK) made *vide* offer of appointment Letter No.SO(C-1)HE/1-13-KP-PSC/Male/Urdu/2020 dated 21st May, 2020, Mr. Rahat Shah, has relinquished the charge of the post of Assistant Professor of Urdu (BPS-18) FG Degree College for Men, Peshawar Cantt. on 29th May, 2020.

This issued with the approval of competent authority *i.e.* Secretary Defence conveyed *vide* U.O. No. 139/D-22/2020, dated 10th June, 2020.

MUHAMMAD GHAFAR, *Lt. Col.*,  
For Director General.

### ISLAMABAD HIGH COURT

Islamabad, the 30th July, 2020

**No. F.(06)/Gen/IHC/9511.**—The competent authority has been pleased to declare that the Islamabad High Court and Civil & Sessions Courts (East & West), Islamabad shall observe "Eid-ul-Azha" holidays from July 31, 2020 to August 2, 2020.

IMTIAZ AHMAD,  
Additional Registrar (Estb).

Islamabad, the 5th August, 2020

**No. PF.(63)/JO/Conf./IHC/731.**—The Competent Authority of this Court has been pleased to grant 7-days earned leave to Ms. Ayesha Shabbir, Civil Judge-*cum*-Judicial Magistrate, Islamabad-West (BPS-18), with effect from 21st July, 2020 to 27th July, 2020, on medical grounds with full pay (without Car / Conveyance Allowance).

NAZIR AHMED BAJWA,  
Deputy Registrar (Conf.).

Islamabad, the 27th July, 2020

**No.19914/Admn/IHC.**—The Competent Authority has been pleased to grant 10-days earned leave on full pay in favour of Ms. Safia Haider, Assistant Librarian (BPS-17) of this Court, on medical grounds, with effect from 21st July, 2020 to 30th July, 2020, as per rules.

MUHAMMAD SARFRAZ SHARIF,  
Deputy Registrar (Admn.).

## JINNAH POSTGRADUATE MEDICAL CENTRE

Karachi, the 21st July, 2020

**No. PF.2.173/SP/ADMN.I/JPMC.**—Mst. Sajida Parveen D/o. Ashiq Hussain, Charge Nurse of this Centre has been granted LFP for 34 days with effect from 4th June, 2020 to 7th July, 2020, subject to title.

She has resumed her duty on 8th July, 2020.

**No. PF.2.262/AH/ADMN.I/JPMC.**—Mr. Abdul Hafeez S/o. Muhammad Siddique, Charge Nurse of this Centre has been granted LFP for 26 days with effect from 12th June, 2020 to 7th July, 2020, on medical grounds, subject to title.

He has resumed his duty on 8th July, 2020.

**No. PF.2.85/SS/ADMN.I/JPMC.**—Mst. Shehla Shaikh D/o. Shaikh Mehboob Hussain, Charge Nurse of this Centre has been granted LFP for 15 days with effect from 30th June, 2020 to 14th July, 2020, on medical grounds, subject to title.

She has resumed her duty on 15th July, 2020.

**No. PF.2.64/NP/ADMN.I/JPMC.**—Mst. Najma Parveen D/o. Nasha Ali, Charge Nurse of this Centre has been granted LFP for 33 days with effect from 10th June, 2020 to 12th July, 2020, on medical grounds, subject to title.

She has resumed her duty on 13th July, 2020.

**No. PF.2.222/SN/Admn.I/JPMC.**—Mst. Sofia Noreen D/o. Iqbal Masih, Charge Nurse of this Centre has been granted LFP for 24 days with effect from 1st June, 2020 to 24th June, 2020, subject to title.

She has resumed her duty on 25th June, 2020.

**No. PF.2.238/S/Admn.I/JPMC.**—Mst. Shazia D/o. George, Charge Nurse of this Centre has been granted LFP for 32 days with effect from 3rd May, 2020 to 3rd June, 2020, on medical grounds, subject to title.

She has resumed her duty on 4th June, 2020.

**No. PF.2.526/KK/Admn.I/JPMC.**—Mr. Khalid Khan S/o. Mukhteruddin, Charge Nurse of this Centre has been granted LFP for 46 days with effect from 18th April, 2020 to 1st June, 2020, on medical grounds, subject to title.

He has resumed his duty on 2nd June, 2020.

**No. PF.2.143/MP/Admn.I/JPMC.**—Mst. Muhahida Parveen D/o. Zahoor Hussain, Charge Nurse of this Centre has been granted LFP for 16 days with effect from 13th June, 2020 to 28th June, 2020, on medical grounds, subject to title.

She has resumed her duty on 29th June, 2020.

Karachi, the 22nd July, 2020

**No. PF.2.129/RB/Admn.I/JPMC.**—Mst. Razia Begum D/o. Muhammad Sadiq, Charge Nurse of this Centre has been granted LFP for 06 days with effect from 15th July, 2020 to 20th July, 2020, on medical grounds, subject to title.

She has resumed her duty on 21st July, 2020.

**No. PF.2.344/KA/Admn.I/JPMC.**—Mst. Kiran Anjum D/o. Yaqub Anjum, Charge Nurse of this Centre has been granted LFP for 28 days with effect from 19th June, 2020 to 16th July, 2020, on medical ground, subject to title.

She has resumed her duty on 17th July, 2020.

**No. PF.2.344/F/Admn.I/JPMC.**—Mst. Fazilat D/o. Ilyas, Charge Nurse of this Centre has been granted LFP for 15 days with effect from 2nd July, 2020 to 16th July, 2020, on medical ground, subject to title.

She has resumed her duty on 17th July, 2020.

**No. PF.2.454/NB/Admn.I/JPMC.**—Mst. Nasreen Bano D/o. Muhammad Taj, Charge Nurse of this Centre has been granted LFP for 28 days with effect from 19th June, 2020 to 16th July, 2020, on medical ground, subject to title.

She has resumed her duty on 17th July, 2020.

Karachi, the 23rd July, 2020

**No. PF.2.385/T/Admn.I/JPMC.**—Mst. Teresa D/o. Amido Anthony, Charge Nurse of this Centre has been granted LFP for 37 days with effect from 11th June, 2020 to 17th July, 2020, on medical ground, subject to title.

She has resumed her duty on 18th July, 2020.

**No. PF.2.533/SM/Admn.I/JPMC.**—Mst. Salma Mazhar D/o. Mazhar Ali, Charge Nurse of this Centre has been granted LFP for 22 days with effect from 2nd June, 2020 to 23rd June, 2020, on medical ground, subject to title.

She has resumed her duty on 24th June, 2020.

**No. PF.2.200/SW/Admn.I/JPMC.**—Mst. Shafqat William S/o. William John, Charge Nurse of this Centre has been granted LFP for 15 days with effect from 1st July, 2020 to 15th July, 2020, on medical ground, subject to title.

He has resumed his duty on 16th July, 2020.

DR. SEEMIN JAMALI T/,  
Executive Director.

MODEL CUSTOMS COLLECTORATE OF  
ENFORCEMENT & COMPLIANCE

Karachi, the 30th July, 2020

**No. 12/2020-Estt(E&C).**—In pursuance of Board's Notification No.1453-C-III/2019 dated 13th June, 2019 and Finance Division O.M No.1(138)R-I/2015-908, Mr. Imtiaz Ahmed Afridi has assumed the charge of Superintendent Preventive Service (BS-17), Model Customs Collectorate of Enforcement & Compliance, Karachi is hereby granted time scale (BS-17) on completion of 03 years service as with effect from 11th May, 2019.

NAYAB AZHAR,  
Assistant Collector Establishment.

MODEL CUSTOMS COLLECTORATE APPRAISEMENT  
AND FACILITATION (EAST)

Karachi, the 5th August, 2020

**No. P.F.2(125)/2006-MCC-East.**—In pursuance of the Federal Board of Revenue's Notification No.1016-C-II/2020, dated 30th July, 2020, Mr. Moeen Afzal Ali, (BS-19), Officer of Pakistan Custom Service, has assumed the charge of the post of Deputy Collector (BS-19), from the MCC Appraisalment and Facilitation (East), Custom House, Karachi, with effect from 30th July, 2020 (Afternoon).

SHAHZAD ALI,  
Assistant Collector HQs.

NATIONAL DATABASE & REGISTRATION AUTHORITY

[REGISTRATION DIRECTORATE]

Islamabad, the 7th August, 2020

**No. NADRA/Regn.8/57-Estt/1764.**—On attaining the age of superannuation, ERP No.8109 Mr. Athar Mahmood, Senior Draftsman (BPS-16) HQ Registration Directorate NADRA Islamabad stands retired from service with effect from 27th July, 2021.

On exercise of option for leave encashment in lieu of LPR, the competent authority is pleased to grant *lump-sum* leave salary equal to 365 days to the officer concerned

in terms of Rule 18-A of Revised Leave Rules 1980, read in conjunction with Finance Division Notification No.SRO.70(KE)/2012 dated 29th August, 2012.

ZAHID ATHAR,  
Assistant Director (Establishment).

NATIONAL COMMISSION FOR HUMAN RIGHTS

Islamabad, the 10th August, 2020

**No. F.2(94)/2017/Admn/NCHR.**—In pursuance of Establishment Division's Notification No.F.39/981/2013-E-I dated 29th July, 2020, Mr. Aftab Alam, a BS-20 Officer of Secretariat Group has relinquished the charge of the post of Director General (BS-20), National Commission for Human Rights, Ministry of Human Rights with effect from 3rd August, 2020.

BAD-E-SABA,  
Assistant Director (Admn-I).

NATIONAL LIBRARY OF PAKISTAN

Islamabad, the 9th July, 2020

**No. F.5-5/2010-Estt.**—In pursuance of Establishment Division's O.M. No.1/21/76/AR.I/R.II dated 18th June, 1980 as amended from time to time. Mr. Muhammad Ibrahim, Assistant Director (F&A) BS-17 in addition to the duties of his own post, is appointed as Deputy Director (F&A) BS-18 on current charge basis in the National Library of Pakistan, Islamabad for a period of three months with effect from 6th July, 2020 to 3rd October, 2020 (90 days).

Mr. Muhammad Ibrahim will be entitled to draw Special pay at admissible under the rules.

This issues with the approval of Director General, National Library of Pakistan, Islamabad.

**No. F.5-9/2010-Estt.**—In pursuance of Establishment Division's O.M. No.1/21/76/AR.I/R.II dated 18th June, 1980 as amended from time to time. Mr. Ajmal Hussain Khan, Junior Librarian (BS-16) in addition to the duties of his own post, is appointed as Assistant Director (BS-17) on current charge basis in the National Library of Pakistan, Islamabad for a period of three months with effect from 9th July, 2020 to 6th October, 2020 (90 days).

Mr. Ajmal Hussain Khan will be entitled to draw Special pay at admissible under the rules.

This issues with the approval of Director General, National Library of Pakistan, Islamabad.

WAQAR HUSSAIN,  
Assistant Director (Admn).

## NATIONAL INFORMATION TECHNOLOGY BOARD

Islamabad, the 30th July, 2020

**No. NITB-1(493)/2017/573.**—In pursuance of Ministry of Information Technology & Telecommunication's Letter No.F.2-10/2015-Admn dated 21st July, 2020 and Establishment Division Notification No.1/34/2016-E-6 dated 15th July, 2020. The competent authority, *i.e.* Executive Director is pleased to extend the contract appointment of Syed Hussnain Abbas Kazmi, Director General (Administration), National Information Technology Board (NITB) under Ministry of Information Technology and Telecommunication in MP-II Scale for a period of one year with effect from 3rd July, 2020 on same terms & conditions.

This issues with the approval of Executive Director.

MUHAMMAD ASLAM LASHARI,  
Director.

After expiry of leave she is expected to join her duties on the same post and station.

**No. F.2-229/16-NIRM.**—Mrs. Rehana Parveen Staff Nurse (BS-16) of this Institute, is hereby granted 10 days leave with full pay from 20th July, 2020 to 29th July, 2020.

After expiry of leave she has assumed her duties on the same post and station.

Islamabad, the 3rd August, 2020

**No. F.2-237/2018-NIRM.**—Mrs. Saima Safdar Staff Nurse (BS-16) of this Institute is hereby granted 15 days leave with full pay from 1st August, 2020 to 15th August, 2020.

After expiry of leave she is expected to assume her duties on the same post and station.

## NATIONAL INSTITUTE OF REHABILITATION MEDICINE

Islamabad, the 22nd July, 2020

**No. 3-30/96-NIRM.**—Dr. Mushtaq Ahmed Bhan Registrar (BS-18) of this Institute is hereby granted 13 days leave with full pay from 27th July, 2020 to 8th August, 2020.

After expiry of leave the officer is expected to assume his duties on the same post and station.

**No. F.2-237/2018-NIRM.**—Mrs. Saima Safdar Staff Nurse (BS-16) of this Institute is hereby granted 15 days leave with full pay from 17th July, 2020 to 31st July, 2020.

After expiry of leave she is expected to assume her duties on the same post and station.

Islamabad, the 23rd July, 2020

**No. F.2-07/95-NIRM.**—Mr. Rashid Akhtar APS (BS-16) of this Institute is hereby granted 30 days leave with full pay from 1st August, 2020 to 30th August, 2020.

After expiry of leave the officer is expected to assume his duties on the same post and station.

Islamabad, the 29th July, 2020

**No. F.105(FA)/PC-NIRM.**—Mrs. Farwa Ali Psychologist (BS-17) of this Institute, is hereby granted 15 days leave with full pay from 3rd August, 2020 to 17th August, 2020. (Subject to title).

**No. F.2-38/96-NIRM.**—Mr. Muhammad Pervaiz Chief Technician (BS-16) of this Institute, is hereby granted 08 days leave with full pay from 3rd August, 2020 to 10th August, 2020.

After expiry of leave he will accordingly assume his duties on the same post and station.

M. B. TAHIR,  
Assistant Director (A).

## OFFICE OF THE INSPECTOR GENERAL, FRONTIER CORPS BALOCHISTAN

Turbat, the 18th July, 2020

**No. 132-37/Prom/40/SE-2-PROMOTION.**—Following promotions were ordered in Frontier Corps Balochistan (South), Turbat with effect from the dates noted against each:-

TO BE SUBEDAR MAJOR ON PROBATION FOR ONE YEAR

1. Number 13346 Subedar (General Duty) Mithoo Khan, Baloch of 109 Wing Taftan Rifles with effect from 19th April, 2020 *vice* No.6336 Subedar Major Mir Rehman proceeded on retirement with effect from 18th April, 2020.

TO BE SUBEDAR ON PROBATION FOR ONE YEAR

2. Number 29895 Naib Subedar (General Duty) Zafar Ali, Pathan of 125 Wing Dasht Scouts with

effect from 17th January, 2020 on an existing vacancy.

3. Number 14268 Naib Subedar (General Duty) Mehboob Ullah, Pathan of 127 Wing Panjgur Rifles with effect from 15th May, 2020 *vice* No.13318 Subedar Rahid Ullah promoted as Subedar Major from the same date.
4. Number 5914 Naib Subedar (General Duty) Mir Khan, Punjabi of 68 Wing Panjgur Rifles with effect from 24th April, 2020 (on completion of two years rank service) *vice* No.8722 Subedar Muhammad Nawaz proceeded on retirement with effect from 5th January, 2020.

TO BE NAIB SUBEDAR ON PROBATION FOR ONE YEAR

5. Number 1208 Havildar (Store Man Technician) Muhammad Abid Shah, Pathan of (Workshop Company) Headquarters Frontier Corps with effect from 12th June, 2020 *vice* No.972 Naib Subedar Zahir Shah promoted as Subedar from the same date.
6. Number 5624 Havildar (General Duty) Muhammad Akram, Pathan of 61 Wing Awaran Militia with effect from 18th April, 2020 (on passing of Basic Leadership Course) *vice* No.5658 Naib Subedar Nek Muhammad posted to 168 Wing Mekran Scouts.
7. Number 15238 Havildar (General Duty) Mehaz Khan, Pathan of 61 Wing Awaran Militia with effect from 18th April, 2020 (on passing of Basic Leadership Course) *vice* No.6250 Naib Subedar Israr Khan posts to 166 Wing Panjgur Rifles.
8. Number 5972 Havildar (General Duty) Muhammad Latif, Punjabi of 137 Wing Panjgur Rifles with effect from 8th July, 2020 *vice* No.8213 Naib Subedar Abdul Ghafoor promoted as Subedar from the same date.

HAFIZ WAQAR AHMED KHAN, *Major*  
For Inspector General.

OFFICE OF THE INSPECTOR GENERAL OF POLICE

[NATIONAL HIGHWAYS & MOTORWAYS POLICE]

Karachi, the 13th July, 2020

**No. NH&MP/Addl.IG/SR(15)/1422.**—Consequent upon transferred from N-5 Central Zone to South Region *vide* CPO NH&MP Islamabad Notification No.NH&MP-3(15)/HRM/2017/Policy/West/EA/1303 dated 2nd July, 2020.

Mr. Iftikhar Ali Wains DSP/CPO (BS-17) has made his arrival at this office on 13th July, 2020.

The above named officer is hereby transferred and posted at Beat-25 Mirpur Mathelo, Sector-I Sukkur South Zone, with immediate effect.

Karachi, the 16th July, 2020

**No. NH&MP/Addl.IG/SR/(15)/1441.**—In exercise of powers conferred on Additional Inspector General, NH&MP, *vide* Letter No.NH&MP-28(11)/2020/Delegation/HRM/1310 dated 2nd July, 2020. The following DSsP/CPOs are hereby transferred / posted at the place as mentioned against each, with immediate effect and until further order:-

S. No.	Name of Officers	From	To
1	CPO Ijaz Haider	Upon arrival	Beat-27 Karamabad, South Zone
2	CPO Noor Min Allah		Beat-13 Mastung, West Zone
3	CPO Zaheer ud Din Babar		Beat-12 Khad Kucha West Zone
4	CPO Khalid Mehmood Nawaz	Beat-27 Karamabad	LHQ Sector-I Sukkur South Zone

2. The above mentioned officers are hereby directed to report at their new place of posting, immediately.

DR. AFTAB AHMED PATHAN, *PSP*  
Additional Inspector General.

Karachi, the 13th July, 2020

**No. DIG/S/N-5/NH&MP/HRM(46)/1900.**—IP/SPO (BS-16) Zeeshan Ahmed (S-1562) S/o. Ansar Ahmed presently posted as Sector-II, Sakrand is hereby granted

ten (10) days casual leave from 25th July, 2020 to 3rd August, 2020.

Karachi, the 17th July, 2020

**No. DIG/S/N-5/NH&MP/HRM(46)/1989.**—In partial modification of this Office Notification No.DIG/S/N-5/NH&MP/HRM/(46)/1737 dated 29th June, 2020, DSP/CPO (BS-17) Hussnain Abbas of Beat-31 Sakrand, was granted eight (08) days monthly rest from 9th July, 2020 to 16th July, 2020 may be read as from 26th July, 2020 to 2nd August, 2020.

2. DSP/CPO (BS-17) Khawar Moin of LHQ, Sector-II, Sakrand will look after the work of CPO-31 during his leave period in addition to his own duties.

MATLOOB AHMAD, *PSP*  
Deputy Inspector General.

Quetta, the 13th July, 2020

**No. NH&MP/DIG(West)AD/HRM-I/2020/218.**—Rao Rashid Khan DSP-CPO (BS-17) of Beat-1, Hub, Sector-I, N-25, Uthal is hereby granted 04-days Casual Leave with effect from 14th July, 2020 to 17th July, 2020.

During the leave period, Admin Officer of Beat-01, Hub, Sector-I, N-25, Uthal will look after the routine affairs in addition to his own assignment in existing pay/ scale.

ALI SHER JAKHRANI, *PPM, PSP*  
Deputy Inspector General.

Multan, the 13th July, 2020

**No. NH&MP/DIG/M-5/OSI/2020/772.**—DSP/CPO Mr. Muhammad Imran (BS-17), presently posted at Beat-27, R.Y.K, Sector-II, Sukkur (M-5) is hereby granted 02 days casual leave, as recommended by the Sector Commander, along with routine monthly rest with effect from 15th July, 2020. The DSP/CPO LHQs, Sector-II (M-5) shall look after the operational/ administrative affairs of Beat-27 during leave of the said officer.

This issues in pursuance of the delegation of administrative powers issued by the Central Police Office, (NH&MP), Islamabad *vide* DIG (HQs) Office Order No.NH&MP-3(7)/2012/Leave/Policy/Estt/1559 dated 31st December, 2014.

**No. NH&MP/DIG/M-5/OSI/2020/776.**—DSP/CPO Mr. Faisal Faraz (BS-17), presently posted at Beat-24, Jalalpur Pirwala, Sector-I, Multan (M-5) is hereby granted 01 day casual leave, along with routine fortnightly rest with effect from 14th July, 2020 to 16th July, 2020 in connection with his some domestic issues. DSP/CPO Beat-23 shall look after the Operational /Administrative Affairs of Beat-24 during leave of the said officer.

This issues in pursuance of the delegation of administrative powers issued by the Central Police Office, (NH&MP), Islamabad *vide* DIG (HQs) Office Order No.NH&MP-3(7)/2012/Leave/Policy/Estt/1559 dated 31st December, 2014.

Islamabad, the 14th July, 2020

**No. NH&MP/DIG/M-5/OSI/2020/787.**—Upon arrival in M-5 Zone in pursuance of Office of the Additional Inspector General, NH&MP, Central Region Notification No.NH&MP/Addl-IGP(CR)/PA/20/336 dated 13th July, 2020, Accountant Sheeraz Ahmad (BS-16) is hereby posted in Sector-II, Sukkur with immediate effect and till further orders.

The said official is directed to report at his new place of posting immediately.

**No. NH&MP/DIG/M-5/AO/2020/793.**—Syed Haider Manzoor, Accountant (BS-16) is hereby appointed as Sanction Conveying Authority of M-5 Zone with immediate effect and till further orders.

MASROOR ALAM KOLACHI, *PSP*  
DIG/Zonal Commander.

Islamabad, the 17th July, 2020

**No. NH&MP-10(3)/Posting/PSP/2017/1399.**—Mr. Matloob Ahmad, PSP/DIG (BS-20) presently posted as DIG N-5 (South) Zone, NH&MP, Karachi is hereby granted twenty one (21) days earned leave with effect from 19th June, 2020 to 6th July, 2020 (both days inclusive) on medical grounds.

This is issues with the approval of Inspector General, NH&MP.

**No. NH&MP-10(9A)/2012/LM/PSP/1398.**—Mr. Ghulam Sarwar Bhayo, PSP/SP (BS-18), presently posted as Sector Commander, N-5 (South-I), NH&MP, Sukkur is hereby granted (10) days casual leave with effect from 20th July, 2020 to 29th July, 2020 (both days inclusive).

2. Mr. Sajjad Hussain Bhatti, presently posted as Acting Sector Commander, N-5 (South-II) is hereby assigned to look after the duties of Sector Commander, N-5 (South-I), Sukkur, in addition to his own duties in own pay & scale, duties during leave of Mr. Ghulam Sarwar Bhayo, PSP/SP (BS-18).

3. This is issued with the approval of Inspector General of Police, NH&MP.

NISAR ALI SOOMRO,  
Deputy Director (HRM).

Islamabad, the 15th July, 2020

**No. NH&MP-10(1)/2020/HRM/SPO/1383.**—IP/SPO Muhammad Shafique Khan, S-1247 is hereby transferred from N-5 (North) Zone to CPO/HQs Zone for further posting in the office of AIG (Operations), NH&MP, with immediate effect and until further orders.

This above mentioned officer shall be relieved immediately with the direction to report at his new place of posting within actual permissible travelling time as provided in Circular issued *vide* No.NH&MP-2(4)/12/SOP/Estt/1385 dated 22nd July, 2015.

Upon relieving of the officer from N-5 (North) Zone, his duly completed and updated Service Record & Last Pay Certificate (LPC) be sent to CPO/HQs Zone, within 07-days.

This is issued with the approval of Inspector General of Police, NH&MP.

SYED HASHMAT KAMAL, PSP  
Assistant Inspector General.

PAKISTAN BUREAU OF STATISTICS

Islamabad, the 3rd August, 2020

**No. FBS.HQ.FA.P(5)/08-729.**—Having exercised the option for encashment of his leave preparatory to retirement in terms of Rule 18-A of the Revised Leave Rules, 1980 amended *vide* Finance Division's S.R.O.70(KE)/2012 dated 29th August, 2012 and with the approval of the competent authority, Mr. Muhammad Afzal, Statistical Officer (BS-17), Pakistan Bureau of Statistics, Regional Office, Multan is granted encashment of LPR in lieu of 365 days leave with effect from 16th August, 2019 to 14th August, 2020.

**No. FBS.HQ.FA.P(5)/08-730.**—Mr. Muhammad Afzal, Statistical Officer (BS-17), Pakistan Bureau of Statistics, Regional Office, Multan shall stand retire from Government

Service on attaining the age of superannuation on 14th August, 2020 (His date of Birth is 15th August, 1960).

SAFIA BEGUM,  
Statistical Officer (Admn-III).

Islamabad, the 3rd August, 2020

**No. PBS.IBD.P-11(05)/85-1065.**—Having exercised the option for encashment of his leave preparatory to retirement in accordance with Finance Division O.M.F.1(73)/R-4/84 dated 18th December, 1984 amended *vide* S.R.O.70(KE)/2012 dated 29th August, 2012 and with the approval of Member (RM), Mr. Muhammad Akram, Private Secretary (BS-17), Pakistan Bureau of Statistics, Islamabad is granted encashment of 365 days with effect from 2nd July, 2020 to 1st July, 2021 in lieu of 365 days leave preparatory to retirement.

Mr. Muhammad Akram, Private Secretary (BS-17), shall stand retired from Government Service with effect from 1st July, 2021 (A.N). His date of Birth is 2nd July, 1961.

**No. PBS.IBD.P-8(19)/2011-1066.**—Having exercised the option for encashment of his leave preparatory to retirement in accordance with Finance Division O.M.F.1(73)/R-4/84 dated 18th December, 1984 amended *vide* S.R.O.70(KE)/2012 dated 29th August, 2012 and with the approval of Member (RM), Mr. Arshad Ahmad Khan, Data Processing Assistant (BS-16), Pakistan Bureau of Statistics, Islamabad is granted encashment of 365 days with effect from 2nd February, 2020 to 31st January, 2021 in lieu of 365 days leave preparatory to retirement.

Mr. Arshad Ahmad Khan, Data Processing Assistant (BS-16), shall stand retired from Government Service with effect from 31st January, 2021 (A.N). His date of Birth is 1st February, 1961.

Islamabad, the 6th August, 2020

**No. PBS.IBD.P-4(235)/2010-111.**—On expiry of the leave granted to her *vide* notification of even number dated 2nd June, 2020, Mrs. Naeema Yousaf, Statistical Officer (BS-17), (Personnel No.50141923), PBS, Islamabad has assumed the charge of the same post at same station on 3rd August, 2020.

Islamabad, the 10th August, 2020

**No. PBS.IBD.P-11(24)/2019-116.**—Consequent upon her selection for the post of Assistant Director, (MIS) (BS-17) in Federal Board of Revenue, Islamabad *vide* their Letter No.F.7(1)Rec-Admn/2019-MIR-III dated 3rd August, 2020 and with the approval of Member (RM), Ms. Nida Asmat, has relinquished the charge of the post of Data Processing Officer (BS-17) in PBS, Islamabad on 10th August, 2020 (AN) to join her new assignment.

SADIA CHAUDHRY,  
Assistant Director (Admn).

## PAKISTAN INSTITUTE OF MEDICAL SCIENCES

Islamabad, the 22nd July, 2020

**No. PF.0015-R/AD/PIMS.**—Dr. Mutahir Shah, Assistant Director/ Vice Principal CMT has been granted 14-days medical leave with full pay with effect from 23rd June, 2020 to 7th July, 2020 on medical grounds.

This issues with the approval of Executive Director.

DR. M. IQBAL KHAN DURRANI,  
Deputy Executive Director.

Islamabad, the 28th July, 2020

**No. PF.7-64(NN)MCH/Admin.**—Ms. Nabeela Neelam, Charge Nurse of MCH, Centre is hereby granted 15 days leave with full pay with effect from 4th June, 2020 to 18th June, 2020 on medical grounds.

**No. PF.7-14(SB)MCH/Admin.**—Ms. Shahnaz Bivi, Charge Nurse of MCH, Centre is hereby granted 07 days leave with full pay with effect from 22nd June, 2020 to 28th June, 2020 on medical grounds.

**No. PF.5-3(AM)MCH/Admin.**—Ms. Attia Mehtab, Head Nurse of MCH, Centre is hereby granted 20 days leave with full pay with effect from 6th August, 2020 to 25th August, 2020. She will resume her duty on 26th August, 2020 on the same place.

**No. PF.4-13(SN)MCH/Admin.**—Dr. Sadia Nasir Kayani, Medical Officer of MCH, Centre is hereby granted 25 days leave with full pay with effect from 20th June, 2020 to 14th July, 2020.

**No. PF.3-10(KM)MCH/Admin.**—Dr. Kausar Masoom, Senior Registrar of MCH, Centre is hereby granted 16 days leave with full pay with effect from 13th July, 2020 to 28th July, 2020. She will resume her duty on 29th July, 2020 on the same place.

**No. PF.7-81(RS)MCH/Admin.**—Ms. Rubina Shaheen, Charge Nurse of MCH, Centre is hereby granted 07 days leave with full pay with effect from 13th July, 2020 to 19th July, 2020.

DR. NASREEN BUTT,  
Deputy Director MCH.

## PAKISTAN INSTITUTE OF TRADE AND DEVELOPMENT

Islamabad, the 7th August, 2020

**No. PITAD-Admn.3(4)/2000.**—The Director General has been pleased to deploy the following officers, on instructional duties to deliver lectures to probationary

officers (Commerce & Trade Group) of 27th Specialized Training Programme in the following subject:-

Sr. No.	Name and Designation	Subject
1.	Ms. Nazish Sami Director (BS-19)	Office Management
2.	Ms. Sadia Khan Dy. Director (BS-18)	Trade Policy
3.	Pir Shah Gul Ahmad Research Associate (BS-17)	General Management

2. The above mentioned officers will be eligible to draw instructional allowance @ 20% of the basic pay not exceeding to Rs.5,000/- per month with effect from 1st May, 2020 to 31st January, 2021.

PIR SHAH GUL AHMED,  
Deputy Director (Admn).

## PAKISTAN METEOROLOGICAL DEPARTMENT

Islamabad, the 22nd July, 2020

**No. E-16(475)/II/SRC/733.**—Mr. Nadeem Mushtaq, Meteorologist (BS-17), Regional Meteorological Centre, Lahore has been granted 30 days leave on full pay from 4th June, 2020 to 3rd July, 2020, with permission to suffix Saturday & Sunday from 4th July, 2020 to 5th July, 2020, subject to admissibility.

On expiry of leave, Mr. Nadeem Mushtaq, Meteorologist (BS-17), resumed duty at the same station on 6th July, 2020.

**No. E-16(746)/III/SRC/741.**—Mrs. Munazza Shakoor, Meteorologist (BS-17), Flood Forecasting Division, Lahore has been granted 60 days leave on full pay from 8th April, 2020 to 6th June, 2020, subject to admissibility.

On expiry of leave, Mrs. Munazza Shakoor, Meteorologist (BS-17), resumed duty at the same station on 8th June, 2020.

Islamabad, the 23rd July, 2020

**No. E-16(886)/SRC/769.**—Mr. Rashid Ali, Electronic Engineer (BS-17), Flood Forecasting Division, Lahore has been granted 24 days leave on full pay from 29th April, 2020 to 22nd May, 2020, with permission to suffix Saturday,



Sunday & Eid Holidays from 23rd May, 2020 to 27th May, 2020 subject to admissibility.

On expiry of leave, Mr. Rashid Ali, Electronic Engineer (BS-17), resumed duty at the same station on 28th May, 2020.

Islamabad, the 24th July, 2020

**No. E-16(746)/II.806.**—Mrs. Munazza Shakoor, Meteorologist (BS-17), Flood Forecasting Division, Lahore has been granted 90 days Maternity leave from 8th January, 2020 to 6th April, 2020, subject to admissibility.

On expiry of leave, Mrs. Munazza Shakoor, Meteorologist (BS-17), resumed duty at the same station on 7th April, 2020.

**No. E-16(522)/810.**—Mr. Asif Hussain, Programmer (BS-17), Climate Data Processing Centre, Karachi has been granted 15 days Rest & Recreation leave in lieu of 10 days leave on full pay from 9th June, 2020 to 23rd June, 2020, subject to admissibility.

On expiry of leave, Mr. Asif Hussain, Programmer (BS-17), resumed duty at the same station on 24th June, 2020.

MUHAMMAD SHOAIB,  
Administrative Officer (Estb).

—  
Karachi, the 24th July, 2020

**No. A3-3(111)/19/2415.**—Mr. Naeem-ul-Haq, Assistant Meteorologist (BPS-16) S.R.R.C, Sukkur Airport under Regional Meteorological Centre, Karachi has been granted 60 days leave on full pay with effect from 20th November, 2019 to 19th January, 2020, subject to admissibility.

On expiry of leave, Mr. Naeem-ul-Haq, Meteorological Assistant (BPS-16) resumed duty at the same station on 20th January, 2020.

MAHMOOD ALI ZAIDI,  
Meteorologist.

---

PAKISTAN PUBLIC WORKS DEPARTMENT

Islamabad, the 6th August, 2020

**No. AI-717/700(1121).**—In pursuance of Ministry of Finance and Revenue (Finance Division) (Regulation Wing)'s Notification SRO.70(KE)/2012, dated 29th August, 2012, the competent authority has been pleased to accept the option for encashment in lieu of LPR exercised by Mr. Riaz-ud-Din, Superintending Engineer (E/M) (BS-19), Pak. PWD, Islamabad and is hereby sanctioned 365-days

leave salary for the period from 28th July, 2020 to 27th July, 2021 subject to condition as laid down in the Finance Division's Notification referred to above.

He will retire from Government Service on the afternoon of 27th July, 2021 on attaining the age of superannuation (being date of Birth 28th July, 1961).

Islamabad, the 7th August, 2020

**No. AI-717/700(2103).**—Consequent upon his transfer *vide* this Office Order No.AI-717/700(1680), dated 17th June, 2020, Mr. Gul Akbar Khan assumed charge to the post of Assistant Executive Engineer, Central E/M Division, Pak. PWD, Peshawar on 22nd June, 2020.

**No. AI-717/700(1796).**—Pursuant to Ministry of Housing & Works Notification No.F.3(2)/2020-Admn-III, dated 30th July, 2020 and this office, Office Order No.AI-717/700(400)/TP-XV, dated 4th August, 2020, Mr. Sajid Ali Khan, on his promotion & posting assumed charge of the post of Executive Engineer (Anti Corruption Cell), D.G's Office, Pak. PWD, Islamabad on 4th August, 2020.

He has been placed on probation for a period of one year under Rule-21 of the Civil Servants (Appointment, Promotion & Transfer) Rules 1973.

**No. AI-717/700(1354).**—Consequent upon his transfer *vide* this office, Office Order No.AI-717/700(1400)/TP-XIV, dated 15th July, 2020, Mr. Muhammad Shafiq Akhtar, assumed charge of the post of Superintending Engineer, Central Civil Circle-II, Pak. PWD, Islamabad on 15th July, 2020.

**No. AI-717/700(1323).**—Consequent upon her transfer *vide* this office, Office Order No.AI-717/700(1400)/TP-XIV, dated 15th July, 2020, Mrs. Humaira Khurram Khan assumed charge of the post of Superintending Engineer/ Staff Officer, Chief Engineer's Office (Central Zone), Pak. PWD, Lahore on 17th July, 2020.

Islamabad, the 10th August, 2020

**No. AI-717/700(1325).**—Consequent upon her transfer *vide* this office, Office Order No.AI-717/700(1400)/TP-XIV, dated 15th July, 2020, Mrs. Nighat Anwar assumed charge of the post of Superintending Engineer, Central Civil Circle, Pak. PWD, Lahore on 17th July, 2020.

**No. AI-717/700(1217).**—Consequent upon his transfer *vide* this office, Office Order No.AI-717/700(1400)/TP-XIV, dated 15th July, 2020, Mr. Muhammad Atiq-ur-Rehman took over charge to the post of Executive Engineer, Central Civil Division, Pak. PWD, Faisalabad from Mr. Nasir Siddique, Executive Engineer on 16th July, 2020.

M. B. KHATTAK,  
Chief Administrative Officer.

## SECRETARIAT TRAINING INSTITUTE

Islamabad, the 30th July, 2020

**No. F.2-1/2020-OMG.**—Consequent upon the completion of Specialized Training Programme (Online) and in pursuance of Establishment Division's Notification No.F.6.2/2019-E-VII, dated 27th July, 2020, the following Probationer Officers of OMG (BS-17) are relieved from STI to join their respective Ministries/ Divisions. Accordingly they have relinquished the charge of the post of Section Officer (Probationer) (BS-17) in the Secretariat Training Institute, Islamabad with effect from 30th July, 2020:-

S. No.	Name
1.	Mr. Adeel Aslam
2.	Ms. Ambreen Mazhar
3.	Mr. Faizan Ullah Khan
4.	Mr. Muhammad Usman Khalid
5.	Ms. Iqra Irshad
6.	Mr. Irfan Ullah
7.	Ms. Khadija Awan
8.	Mr. Muhammad Umar Draaz
9.	Mr. Rasheed Ahmed Shah Rashdi
10.	Ms. Sana Shouket
11.	Mr. Sarmad Jabbar
12.	Ms. Sidra Khan
13.	Mr. Yahya Tariq Cheema
14.	Mr. Abdul Baqi
15.	Mr. Allahyar Khan Kalwar

S. No.	Name
16.	Ms. Amna Farooq
17.	Mr. Asad Ullah
18.	Mr. Haider Ali
19.	Ms. Iqra Khan
20.	Mr. Kashif Ali
21.	Mr. Khizar Faiz
22.	Mr. Muhammad Awais Tariq
23.	Mr. Muhammad Waleed Bin Saad
24.	Ms. Ramish Hassan Rana
25.	Mr. Shoaib Raza Gopang
26.	Mr. Abdullah Khan
27.	Ms. Ayesha Farzand Ali
28.	Mr. Daniyal Khan
29.	Mr. Haider Gul
30.	Mr. Junaid Afzal
31.	Ms. Maria Gul
32.	Ms. Mariya Farheen
33.	Ms. Mehwish Shabbir
34.	Mr. Muhammad Adeel Akbar

S. No.	Name
35.	Mr. Muhammad Saad Munir
36.	Ms. Paras Mahesar
37.	Ms. Pirah Aftab
38.	Syed Ali Hasnain
39.	Syed Asad Hasan
40.	Syeda Rida Kazmi
41.	Syeda Sidra Majid
42.	Mr. Ahmed Saleem
43.	Mr. Ali Nawaz Channa
44.	Ms. Amina Tahir
45.	Mr. Amjad Raja
46.	Mr. Anum Sidique
47.	Ms. Sadia Pirzada
48.	Mr. Imran Ali
49.	Mr. Jawwad Raza Sultan
50.	Ms. Maryam Ahmed
51.	Mr. Muhammad Awais Qarni
52.	Mr. Muhammad Siddiq

S. No.	Name
53.	Mr. Shahab Uddin
54.	Syed Muhammad Zuhair Jafar
55.	Mr. Asif Khan
56.	Ms. Bushra Nawaz
57.	Mr. Danish Ali Mughal
58.	Ms. Farah Mumtaz
59.	Mr. Muhammad Zubair Abdullah
60.	Mr. Musawir Sifat
61.	Mr. Nasar Hayat
62.	Ms. Sania Akram Khan
63.	Syed Minhas Mahmood
64.	Syeda Yusra Gilani
65.	Ms. Uzma Naz Satti
66.	Ms. Zakya Rubab
67.	Ms. Zeenat Tariq
68.	Ms. Zoya Zafar
69.	Mr. Muhammad Namaan Mustafa
70.	Ms. Fakhira Akram

S. No.	Name
71.	Mr. Muhammad Hassan
72.	Raja Shahroze Abbas
73.	Ms. Iqra Khan

MUHAMMAD MUZAFFAR KHAN,  
Director (OMG).

TRADE DEVELOPMENT AUTHORITY OF PAKISTAN

Karachi, the 28th July, 2020

**No. TDAP-P(2200)/Estt-I/2009.**—In pursuance of TDAP Office Order dated 28th July, 2020, Ms. Adeela Younis, TDAP Lahore, after availing 45 days maternity leave with effect from 4th May, 2020 to 17th June, 2020, has assumed the charge of the post of Director (BS-19) on 18th June, 2020 at TDAP Lahore.

**No. TDAP-P(1972)/Estt-97.**—In pursuance of Ministry of Commerce's Notification No.2(2)/2020-DD-CTG dated 9th July, 2020, Mr. Ateeq-ur-Rehman, a BS-18 Officer of Commerce & Trade Group has relinquished the charge of the post of Deputy Director (BS-18), TDAP, Lahore on 15th July, 2020 and assumed the charge of the post of Director (BS-19), TDAP, Karachi on 16th July, 2020.

**No. TDAP-P(2381)/Estt-2020.**—In pursuance of Ministry of Commerce's Notification No.2(2)/2020-D.D(CTG) dated 10th July, 2020, the Acting Charge as Director in BS-19, given to Mr. Jabbar Tooqir, as BS-18 Officer of Commerce and Trade Group/ Deputy Director, TDAP Karachi is hereby withdrawn with effect from 10th July, 2020.

Karachi, the 29th July, 2020

**No. TDAP-P(2231)/Estt-2011.**—Ms. Fatima Khalil, a BS-18 Officer of Commerce & Trade Group / Deputy Director, TDAP, Islamabad after availing medical leave with effect from 27th February, 2020 to 15th April, 2020 has assumed the charge of the post of Deputy Director, TDAP, Islamabad.

KALEEMULLAH MEMON,  
Deputy Director (Estt).

Karachi, the 5th August, 2020

**No. TDAP-P(2206)/Estt-2010.**—In pursuance of Trade Development Authority of Pakistan, Karachi notification of even number dated 28th July, 2020, Ms. Mehwish Khadim, a BS-19 Officer of Commerce & Trade Group/ Director, TDAP, Karachi has relinquished the charge of the post of Director (BS-19), TDAP, Karachi on 29th July, 2020 and assumed the charge of the post of Director (BS-19), TDAP, Lahore on 3rd August, 2020.

Karachi, the 6th August, 2020

**No. TDAP-P(2200)/Estt-I/2009.**—In pursuance of Trade Development Authority of Pakistan, Karachi's notification of even number dated 28th July, 2020, Ms. Adeela Younis, a BS-19 Officer of Commerce & Trade Group/ Director, TDAP, Lahore has relinquished the charge of the post of Director (BS-19), TDAP, Lahore on 4th August, 2020 and assumed the charge of the post of Director (BS-19), TDAP, Karachi on 5th August, 2020.

**No. TDAP-P(2200)/Estt-I/2009.**—The Secretary, Trade Development Authority of Pakistan has been pleased to grant one hundred and eighty (180) days earned leave on half pay with effect from 10th August, 2020 to 5th February, 2021 Ms. Adeela Younis, Director, Trade Development Authority of Pakistan, Karachi,

ALTAF HUSSAIN,  
Assistant Director (Estt-I).

# The Gazette of Pakistan

PUBLISHED BY AUTHORITY

KARACHI, WEDNESDAY, OCTOBER 7, 2020

## PART IV

### Notifications issued by the minor administrations and miscellaneous notifications not included in any other part

MINISTRY OF PLANNING, DEVELOPMENT & SPECIAL INITIATIVES

Islamabad, the 10th September, 2020

**No. F. 5(12)CP/HRM-IV/PDR/2019.**—Secretary, Ministry of Planning, Development & Special Initiatives has been pleased to constitute Working Group for preparation of Five Year Plan for Socio Economic Development of Gilgit Baltistan, Composition of the Working Group for the following Sectors/areas is at Annex-I :-

- Working of the Groups will be documented in the form of a report that will be utilized in writing of plan document.
- Any other task relating to their sector which the Working Group deems appropriate.

**Annex-I**

#### **Working Groups for Preparation of Five Year Plan for Socio Economic Development of Gilgit Baltistan**

S. No.	Sector / Area
i.	Gems and Minerals
ii.	Education
iii.	Agriculture Business Development
iv.	Tourism and Allied Facilities
v.	Overview of PSDP Program
vi.	Clean Energy & Off Grid Solutions
vii.	Employment and Skill Development
viii.	Health
ix.	Climate Change

I) Working Group on Gems and Minerals	
Sr. No.	Name of Members
1.	Mr. Riaz Ahmed Sahito, Chief (Industries and Commerce) Ministry of PD&SI, Islamabad.
2.	Mr. Muhammad Hussain, Deputy Secretary (Mines & Minerals Department) University Road, Gilgit.
3.	Mr. Muhammad Zubair, Deputy Director (Mines Mineral Department), Gilgit.
4.	Mr. Sift Shah, Pakistan Gemstone & Mineral Association.
5.	Mr. Hussain Summayeri, Pakistan Gemstone & Mineral Association.
6.	Haji M. Ali Pathan, Pakistan Gemstone & Mineral Association.
7.	Haji Zarmast Khan, Azhar Gems & Minerals
8.	Mr. Arif Hussain, The. Gems Hunter.
9.	Mr. Mehmood ul Hassan (Assistant Chief) P&D Department, Government of Gilgit Baltistan.
10.	Mr. Zubair (Director Minerals), Government of Gilgit Baltistan.

#### **A. Terms of Reference for the Working Groups :-**

- Working Group after deliberations and discussion will identify the issues of their respective area/sector and formulate policy recommendations (policies, reforms, programs investments) for socioeconomic development of GB in next five years.

<b>II) Working Group on Education</b>		<b>IV) Working Group on Tourism and Allied Facilities</b>	
<b>Sr. No.</b>	<b>Name of Members</b>	<b>Sr. No.</b>	<b>Name of Members</b>
1.	Mr. Mumtaz Ali Sheikh, Chief (Education) Ministry of PD&SI, Islamabad.	1.	Mr. Waheed Zaman, Chief (Mass Media & CSTY) Ministry of PD&SI, Islamabad.
2.	Dr. Muhammad Ikram Malik, Associate Professor Agriculture Arid University, Shamsabad, Rawalpindi.	2.	Managing Director, PTDC,
3.	Dr. Fazal ur Rehman, Chairman, Education Department, Allama Iqbal Open University, H-8 Sector, Islamabad.	3.	Secretary Tourism, Government of Gilgit Baltistan.
4.	Mr. Salman Naveed, Head Policy Wing, Alif Ailaan, Islamabad.	4.	President, Alpine Club of Pakistan,
5.	Baela Raza Jamil, CEO (ITA), Islamabad.	5.	Representative, Travel Agents Association of Pakistan.
6.	Dr. Saba Gul Khattak, Country Director, FOSIT Serena Business Complex.	6.	Mr. Asghar Ali Porik, Vice President, Pakistan Association of Tour Operators (PATO).
7.	Mr. Israr Ahmed (Deputy Chief), P&D Department, Government of Gilgit Baltistan.	7.	Mr. Muhammad Akhtar Bawany, Vice Chairman, Pakistan Services Limited/Hashoo Hotel.
8.	Abid Naeem (Deputy Director Education), Government of Gilgit Baltistan.	8.	President, Sustainable Tourism Foundation, Pakistan.
9.	Dr. Saleem ud din (DG Health Department), Government of Gilgit Baltistan.	9.	Mr. Irshad Khan Abbasi, Director, Agha Khan Foundation, Islamabad.
10.	Dr. Sughra Chaudry Khan, Director Education Unit Aga Khan Foundation, Pakistan.	10.	Mr. Niaz Ali Malkani, Director, Pakistan Institute of Tourism and Hotel Management (PITHM).
11.	Asim Iftkhar, Head of Human Resource and Operations, Aga Khan Education Services Pakistan.	11.	Ms. Najma Farman (SDG Coordinator), P&D Department, Government of Gilgit Baltistan.
<b>III) Working Group on Agriculture Business Development</b>		12.	Ms Ayesha Khurshid (Assistant Chief) P&D Department, Government of Gilgit Baltistan.
1.	Mr. Shehzad Ahmed Baloch, Chief (Food, Agriculture & Climate Change) Ministry of PD&SI, Islamabad.	13.	Mr. Iqbal (Director Tourism), Government of Gilgit Baltistan.
2.	Chairman, Pakistan Agriculture Research Council	<b>V) Working Group on Overview of PSDP Program</b>	
3.	Joint Secretary (Dev), Ministry of National Food Security & Research.	1.	Malik Ahmed Khan, CEO, Public Private Partnership Authority.
4.	Additional Secretary, Ministry of Kashmir Affairs & Gilgit Baltistan.	2.	Dr. Shabnum Sarfraz, Member (Social Sector & Devolution), Planning Commission.
5.	Ghulam Rasool (Deputy Chief), P&D Department, Government of Gilgit Baltistan.	3.	Mr. Asif Khan, Chief (Public Investment Programing) Ministry of PD&SI, Islamabad.
6.	Muhammad Alam (Assistant Chief), P&D Department, Government of Gilgit Baltistan.	4.	Joint Secretary (Budget), Finance Division.
7.	Mr. Javed Akhtar (Deputy Director Agriculture Department) Government of Gilgit Baltistan.	5.	Dr. Amanullah, Joint Chief Economist, Planning and Development Board, Government of Punjab.
		6.	Mr. Ashfaq Ahmed, Deputy Chief (D&AD)

Sr. No.	Name of Members
7.	Dr. Vaqar Ahmed, Dy. Executive Director, Sustainable Development Policy Institute (SDPI), Islamabad.
8.	Muhammad Usman Khan, Innovation and Research Advisor, DFIF funded sub National Governance Programme, Lahore.
9.	Ms. Aisha Khan, Executive Director, Mountain & Glacier Protection Organization.
10.	Dr. Saranjam Baig, Chairman Economics Department, University of Karakoram.
11.	Mr. Sajjad Hyder, Deputy Chief, Planning and Development Department, Government of Gilgit Baltistan.
12.	Rahat Ullah Baig, Head Program Development and Knowledge Management Agha Khan Planning and Building Services of Pakistan (AKPBS).
13.	Mr. Masood Mir, Program Manager/Head of Economic Development Agha Khan Rural Support Program.
<b>VI) Working Group on Clean Energy and off Grid Solutions</b>	
1.	Mr. Muhammad Arshad Khan, Chief (Power) Ministry of PD&SI, Islamabad.
2.	Syed Akhtar Ali, Ex-Member (Energy), Planning Commission.
3.	Mr. Asif Jaan, General Manager (Hydel), Water & Power Development Authority (WAPDA).
4.	Mr. Maqsood Ahmad Qureshi, Advisor (Power System Planning), National Transmissions & Despatch Company (NTDC).
5.	Mr. Munawar Iqbal, Director Hydropower, Private Power and Infrastructure Board (PPIB).
6.	Engineer Suleman Wali, Ex Chief Engineer PWD & Power, Secretary P&D Department (Retd.), Government of Gilgit Baltistan.
7.	Mr. Naeem Memon, Alternative Energy Development Board (AEDB), Power Division.
8.	Engineer Sher Khan, Country Manager, M/s. Integration Environment & Energy.
9.	Mr. Faisal Usman (Deputy Chief) P&D Department, Government of Gilgit Baltistan.
10.	Mr. Ghulam Murtaza (CE Power), Government of Gilgit Baltistan.

Sr. No.	Name of Members
<b>VII) Working Group on Employment and Skill Development</b>	
1.	Mr. Shahid Zia Cheema, Chief (Employment & Research), Ministry of PD&SI, Islamabad.
2.	Mr. Ismail Iqbal, Deputy Secretary (Emigration), Ministry of OP& HRD.
3.	Mrs. Zainab Bibi, Assistant Chief (Manpower), Ministry of PD&SI.
4.	Mr. Israr-ul-Haq, Director (Dev), NAVTTC, Islamabad.
5.	Mr. Javed Iqbal (Deputy Chief), P&D Department, Government of Gilgit Baltistan.
6.	Mr. Shahid Ali (Deputy Director Agriculture Department), Government of Gilgit Baltistan.
7.	Ms. Naila Abbas Dar, Assistant Chief (Employment & Research) Ministry of PD&SI.
8.	Mr. Sherzad Ali Khan, Program Coordinator GBC, Agha Khan Foundation Pakistan.
<b>VIII) Working Group on Health</b>	
1.	Dr. Muhammad Asif, Chief (Health), Ministry of PD&SI, Islamabad.
2.	Dr. Assad Hafeez, Vice Chancellor Health Services Academy, Islamabad.
3.	Dr. Shahzad Ali Khan, Head of Department, Public Health, Health Services Academy, Islamabad.
4.	Dr. Saifi Malik, Director General Health, Ministry of NHSRC, Islamabad.
5.	Dr. Raza Zaidi, Health System Specialist, Ministry of NHSRC, Islamabad.
6.	Dr. Karm Shah, CDC Advisor, Ministry of NHSRC, Islamabad.
7.	Dr. Sameen Siddiqi, Chair Community Medicine Department, Agha Khan University, Karachi.
8.	Dr. Naila, IHR Focal Person for Poultry Ministry of National Food Security and Research, Islamabad.
9.	Dr. Amir Bin Zahoor, IHR Focal Person for Livestock, Ministry of National Food Security and Research, Islamabad.
10.	Dr. Baseer Achakzai, Coordinator Nutrition Ministry of National Health Services and Coordination, Islamabad.
11.	Maj. Gen. Dr. Aamir Akram, Executive Director, National Institute of Health, Islamabad.
12.	Ms. Falak Madhani, Head of Programs and Research Agha Khan Health Services of Pakistan (AKHS).

Sr. No.	Name of Members
<b>IX) Working Group on Climate Change</b>	
1.	Mr. Faisal Ali Baloch (Deputy Chief) Ministry of PD&SI, Islamabad.
2.	Dr. Aqib Hassan Ali Khan, YDF, Ministry of PD&SI.

Sr. No.	Name of Members
3.	Mr. Sajjad Haider (Deputy Chief), P&D Department, Government of Gilgit Baltistan.
4.	Mr. Shahzad Shigri (Director EPA), Government of Gilgit Baltistan.

GHULAM NABI SHAIKH,  
Section Officer (HRM-IV).



# The Gazette of Pakistan



PUBLISHED BY AUTHORITY

KARACHI, WEDNESDAY, OCTOBER 7, 2020

## PART V

Notifications, etc., issued by The Patent Office

### NEW APPLICATIONS FOR THE PATENTS

The dates shown in the crescent brackets are the dates claimed under section 86 of the Patents Ordinance 2000.

#### 9th December, 2019

824/2019 SHELL INTERNATIONAL RESEARCH MAATSCHAPPIJ B.V, Netherlands (Priority 11th December, 2018, EP).—“ALKANE OXIDATIVE DEHYDROGENATION AND/OR ALKENE OXIDATION”.

825/2019 UMAIR, Pakistan.—“Sulphur Coated Urea with Biodegradable Adhesives”.

826/2019 ELI LILLY AND COMPANY, U.S.A (Priority 21st December, 2018, US and 21st December, 2018, US).—“ANTI-ANGPTL3/8 COMPLEX ANTIBODIES AND METHODS OF USING THE SAME”.

#### 10th December, 2019

827/2019 Haldor Topsoe A/S, Denmark (Priority 12th December, 2018, DK).—“Catalyst Particle Shape”.

#### 11th December, 2019

828/2019 Dr. Muhammad Tahir and Hammad Hassan, Pakistan.—“AUVIS: Audire Vigilant System”.

829/2019 Rizwan, Syedah Afsheen Zahra, Ayesha Zaheer, Pakistan.—“Hybrid Super-Capacitor based on laser Fabricated PI/MXene electrodes for efficient Energy Storage Application”.

830/2019 Syed Rizwan, Jameela Fatheema, Sabeen Fatima, Pakistan.—“Fabrication of Resistive RAM with Contact-On-Substrate Design Scheme”.

831/2019

Usama Zameer, School of Electrical Engineering and Computer Science (SEECs) and Muhammad Usama Ghani, School of Electrical Engineering and Computer Science (SEECs), Pakistan.—“Glasses for Blind”.

832/2019

National University of Sciences & Technology, Pakistan.—“Asynchronous Backward-Forward Sequence Generative Approach for Sentence Generation using Multiple Lexical Constraints”.

833/2019

Eli Lilly and Company, U.S.A (Priority 21st December, 2018, US and 21st December, 2018, US).—“ANTI-ANGPTL3/8 COMPLEX ANTIBODIES AND METHODS OF USING THE SAME”.

#### 12th December, 2019

834/2019

SYNGENTA CROP PROTECTION AG, Switzerland (Priority 14th December, 2018, EP).—“PESTICIDALLY-ACTIVE CYANAMIDE HETEROCYCLIC COMPOUNDS”.

835/2019

EISAI R & D Management Co., Ltd, Japan (Priority 13th December, 2018 US and 13th December, 2018, US).—“HERBOXIDIENE SPLICING MODULATOR ANTIBODY- DRUG CONJUGATES AND METHODS OF USE”.

836/2019

Mr. Raheel Abbas, Pakistan.—“Large scale rectangular coordinate system kinetics hybrid fused filament fabrication 3d printer and CNC”.

837/2019

ADVERIO PHARMA GMBH, Germany (Priority 17th December, 2018, EP).—“METHYL (4,6-DIAMINO-2-[5-FLUORO-1-(2-FLUOROBENZYL)-1H-PYRAZOLO[3,4-B]PYRIDIN-3-YL]PYRIMIDIN-5-YL} CARBAMATE ACTIVE COMPOUND PRODUCT HAVING IMPROVED PROPERTIES, PRODUCTION AND FORMULATION THEREOF”.

## 13th December, 2019

838/2019 ROMET LIMITED, Canada (Priority 20th June, 2019, US).—"DIRECTION SELECTIVE UNIDIRECTIONAL CLUTCH ASSEMBLY FOR A FLUID METER COUNTER MODULE ASSEMBLY AND FLUID METER WITH A DIRECTION SELECTIVE UNIDIRECTIONAL CLUTCH ASSEMBLY".

839/2019 ROMET LIMITED, Canada (Priority 13th June, 2019, US).—"SIDE VIEW FLUID METER COUNTER ASSEMBLY AND A FLUID METER WITH A SIDE COUNTER".

**APPLICATION ACCEPTED**

Notice is hereby given that the person interested in opposing the grant of Patents to any of the applications referred to below at any time within four months from the date of this Patents' journal may give notice at the Patent Office on the prescribed Form P-7 of the Patents Rules 18(1) of 2003.

The six figures number shown in the right hand side are those given to applications on acceptance of the complete specification under which the specification will be printed and subsequent proceeding taken.

The figures shown within square brackets after the title of inventions indicate their classification index at acceptance.

Typed copies of the specification which are to open to public inspection can be supplied by the Patent Office on payment of the prescribed charges which may be ascertained on application to the office.

568/2008 SYED BURHANUDDIN ABDALI; SYED MOHSIN ALI; Z. A. DHAKAN and MUHAMMAD ADIL, Pakistan.—"A Process for production of Magnesium carbonate from Sea Bittern".

B01D61/44

143380

A process has been developed to produce magnesium carbonate from sea bittern having a density between 28° to 30°Be *i.e.* (1.24 - 1.27 gm/cc) contains magnesium, which is de-sulfated and de-chloride from sodium carbonate (Na<sub>2</sub>CO<sub>3</sub>) to convert Mg ++ ions to magnesium carbonate and a mixture of sodium sulphate and sodium chloride. Soda ash solution of suitable concentration is added instantly (with in 5-10 sec) to bittern solution diluted to the required concentration in a reactor of standard design fitted with a speed controlled stirrer, the content of the reaction vessel is kept for 30 minutes with stirring of 140-280 rpm after the addition of

soda ash solution. After filtration, magnesium carbonate is washed several times to make it free from sulphate and chloride ions. Magnesium carbonate in the form of cake is dried in a ventilated oven at temperature 80°C - 100 °C and ground to get fine powder of magnesium carbonate having the bulk density of 0.1 - 0.125 gm/cc.

511/2012 BOEHRINGER INGELHEIM INTERNATIONAL GmbH, Germany.—"Phenyl-3-aza-bicyclo [3.1.0]hex-3-yl-methanone".

C07D401/04, A61K31/427 &amp; A61P25/28.

143381

The present inventions relates to substituted phenyl-3-aza-bicyclo[3.1.0]hex-3-yl-methanones of general formula (I).

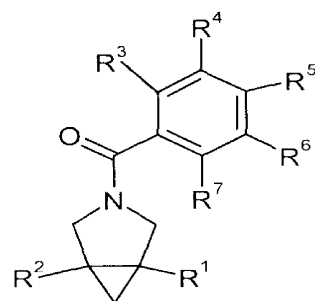

(I)

wherein R<sup>1</sup>, R<sup>2</sup>, R<sup>3</sup>, R<sup>4</sup>, R<sup>5</sup> and R<sup>6</sup> are as herein described. The invention further relates to the manufacture of said compound, pharmaceutical compositions comprising a compound according to general formula (I). The compound of the invention shows glycine transporter-1 (GlyT1) inhibiting properties.

685/2013 REGULUS THERAPEUTICS INC., U.S.A.—"MODIFIED OLIGONUCLEOTIDE FOR USE IN TREATING ALPORT SYNDROME".

C12N15/113, A61K31/7125 &amp; A61P13/12.

143382

Provided herein is modified oligonucleotide targeted to miR-21 for use in the treatment of Alport Syndrome. In certain embodiment, a modified oligonucleotide targeted to miR-21 improves kidney function and/or reduces fibrosis in subjects having Alport Syndrome. In certain embodiment, administration of a modified oligonucleotide targeted to miR-21 delays the onset of end-stage renal disease in a subject having Alport Syndrome. In certain embodiment, a modified oligonucleotide targeted to miR-21 delays the need for dialysis or kidney transplant in a subject having Alport Syndrome.

919/2013 MIDREX TECHNOLOGIES, INC., U.S.A.—  
“METHOD FOR SEQUESTERING CARBON  
DIOXIDE FROM A SPENT GAS”

143384

B 01D53/00.

143383

A method for sequestering carbon dioxide from a waste gas and reusing it as a recycled gas without emissions concerns, including: given a gas source divided into a process gas and a waste gas: mixing the process gas with a hydrocarbon and feeding a resulting feed gas into a reformer for reforming the feed gas and forming a reducing gas; and feeding at least a portion of the waste gas into a carbon dioxide scrubber for removing at least some carbon dioxide from the waste gas and forming a carbon dioxide lean gas that is mixed with the reducing gas. Optionally, the method also includes feeding at least a portion of the waste gas into the carbon dioxide scrubber for removing at least some carbon dioxide from the waste gas and forming a fuel gas after the addition of a hydrocarbon that is fed into the reformer. Optionally, the gas source and the reducing gas are associated with a direct reduction process for converting iron oxide to metallic iron in a reduction furnace that utilizes the reducing gas, optionally after some modification, and produces the gas source.

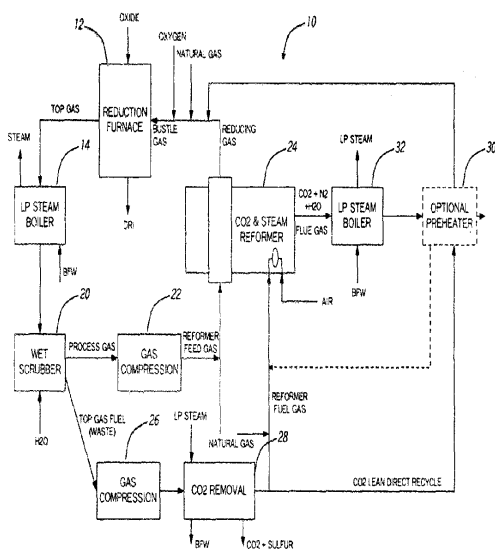

99/2014 PFIZER INC, U.S.A.—“N-{CIS-3-  
[METHYL(7H-PYRROLO[2,3-D]PYRIMIDIN-  
4-YL)AMINO]CYCLOBUTYL}- COMPOUND  
AND COMPOSITION THEREOF”.

C07D487/04 &amp; A61K31/519.

The present invention relates to a pharmaceutically active pyrrolo[2,3-D]pyrimidine compound of formula 1:

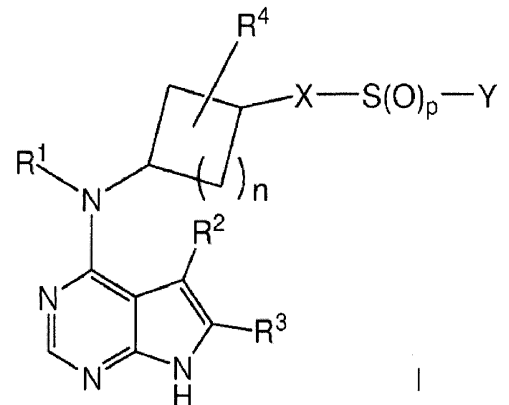

and composition thereof wherein the various substituent groups, R<sub>1</sub>, R<sub>2</sub>, R<sub>3</sub>, R<sub>4</sub>, X and Y are as described in claims for treating and preventing a condition mediated by Janus Kinase (JAK).

120/2014 CJ CHEILJEDANG CORPORATION, Rep. of Korea.—“Bacteriophage and antibacterial composition active against Clostridium perfringens”

A01N63/00, C12N7/01, C12N7/00 & A61P31/04.

143385

Provided is a novel bacteriophage Korean Culture Center of Microorganisms 11363P (KCCM11363P). In addition, the present invention relates to an antibacterial composition including the bacteriophage Korean Culture Center of Microorganisms 11363P (KCCM11363P) as an active ingredient.

391/2014 SAIPEM S.p.A., Italy.—“METHOD FOR RECOVERING AMMONIUM SULPHATE FROM A UREA PLANT GAS STREAM”.

C01C1/242 &amp; C01C1/12.

143386

A method of recovering ammonium sulphate from a gas stream produced in a urea plant (1), and in particular by a solidification unit (10) of the urea plant, the method including the steps of: treating a gas stream from a solidification unit (10) in a scrubber (13) to remove ammonia from the gas steam and form an ammonium sulphate solution; mixing

the ammonium sulphate solution from the scrubber (13) with a low-concentration urea solution produced in the urea plant (1), and removing water in an evaporator (15), to form a urea-ammonium sulphate eutectic; and feeding the eutectic, mixed with high-concentration urea melt produced by the urea plant (1), to the solidification unit (10).

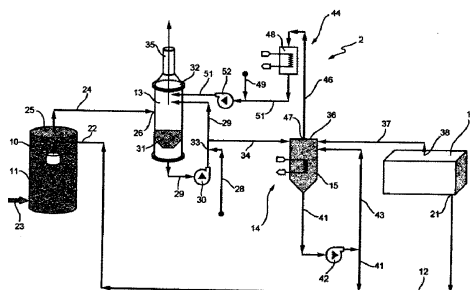

519/2014 FMC Corporation, U.S.A.—“INSECT ACARID REPELLENT COMPOSITION COMPRISING A C8-C24 FATTY ACID AND ANTHRANILATE ESTER”.

A01N 37/00 & A01N33/06.

143387

A pest repellent composition comprising (a) an anthranilate ester; and (b) a fatty acid selected from the group consisting of saturated and unsaturated fatty acids containing from 8 to 24 carbon atoms. In addition, a method of repelling pests employing such composition.

887/2014 F. HOFFMANN-LA ROCHE AG, Switzerland.—“Sprio-Oxazolone”.

C07D491/20, A61K31/438 & A61P5/00.

143388

The present invention relates to a compound of formula I,

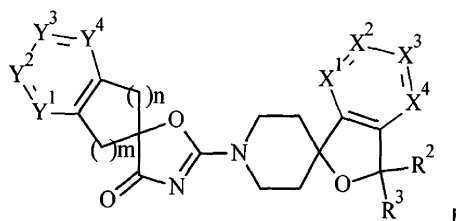

wherein

X<sup>1</sup> is C-R<sup>1</sup> or N;

X<sup>2</sup> is C-R<sup>1</sup> or N;

X<sup>3</sup> is C-R<sup>1</sup> or N;

X<sup>4</sup> is C-R<sup>1</sup> or N;

whereby only one of X<sup>1</sup>, X<sup>2</sup>, X<sup>3</sup> and X<sup>4</sup> is N;  
R<sup>1</sup> each separately is selected from the group consisting of hydrogen, halogen, hydroxy, C<sub>1-6</sub>-alkyl and C<sub>1-6</sub>-alkoxy;  
R<sup>2</sup> is selected from the group consisting of H and C<sub>1-6</sub>-alkyl;  
R<sup>3</sup> is selected from the group consisting of H and C<sub>1-6</sub>-alkyl; or R<sup>2</sup> and R<sup>3</sup> together are= O;

Y<sup>1</sup> is C-R<sup>4</sup> or N;

Y<sup>2</sup> is C-R<sup>4</sup> or N;

Y<sup>3</sup> is C-R<sup>4</sup> or N;

Y<sup>4</sup> is C-R<sup>4</sup> or N;

whereby only one of Y<sup>1</sup>, Y<sup>2</sup>, Y<sup>3</sup> and Y<sup>4</sup> is N;

R<sup>4</sup> each separately is selected from the group consisting of hydrogen, halogen, halogen-C<sub>1-6</sub>-alkyl, hydroxy, C<sub>1-6</sub>-alkyl, C<sub>1-6</sub>-alkoxy and Si(C<sub>1-6</sub>-alkyl)<sub>3</sub>;

m is 1, 2 or 3; and

n is 0 or 1;

890/2014 CASALE SA, Switzerland.—“TUBE HEAT EXCHANGE UNIT FOR INTERNALS OF HEAT EXCHANGER OR REACTOR”.

B01J8/04, F28F9/22 & F28F9/013.

143389

Tube-bundle heat exchange unit (1) for internals of heat exchangers or reactors, comprising: at least one tube bundle (2); a plurality of baffles (3) associated with said tube bundle and defining through-openings according to a predefined arrangement, each opening being passed through by one of more tubes of the tube bundle, and a shell (6) which surrounds said tube bundle and said baffles, wherein the assembly of the tube bundle and the shell can be disassembled and the shell is structurally collaborating with the tube bundle through said baffles.

2/2015 SAINT-GOBAIN PLACO, France.—“PLASTER-BASED MATERIAL CONTAINING CASEIN AND ACTIVE CHARCOAL”.

C04B111/00, C04B28/14 & C04B 24/38.

143390

The present invention relates to a plaster-based material, in particular a plasterboard intended for the interior fitting of dwellings, which contains a mixture of casein and active charcoal. A subject of the invention is also the use of the said material for reducing the amount of volatile organic compounds present in the atmosphere inside dwellings, offices or public buildings.

4/2015

F. HOFFMANN-LA ROCHE AG, Switzerland.—  
“ETHYNYL compound”.

143392

C07D401/04, C07D233/64, A61K31/506 &  
A61P25/18.

143391

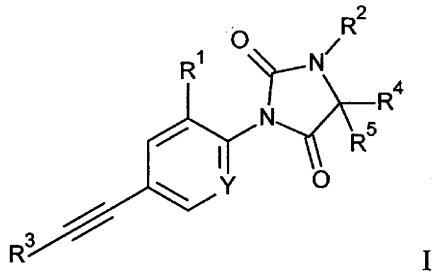
The present invention relates to compound of  
formula I

Wherein

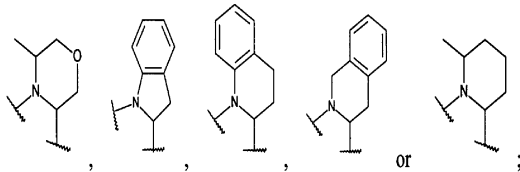
Y is C-R<sup>1'</sup>;R<sup>1'</sup> is hydrogen or halogen;R<sup>1'</sup> is hydrogen or halogen;R<sup>2</sup> is hydrogen, lower alkyl or phenyl,;R<sup>4</sup> is hydrogen or lower alkyl;or R<sup>2</sup> and R<sup>4</sup> may form together with the  
corresponding atoms, to which they are  
attached the following ringsR<sup>5</sup> is hydrogen or lower alkyl; and if R<sup>2</sup> and  
R<sup>4</sup> form a ring as described above, than R<sup>5</sup> is  
hydrogen; orR<sup>4</sup> and R<sup>5</sup> may form together with the C-atom  
to which they are attached a heterocycloalkyl  
ring;R<sup>3</sup> is phenyl or pyridinyl, wherein the N  
atom in the pyridinyl group may be in different  
positions;The compound may be used for the treatment  
of Parkinson's disease, anxiety, emesis,  
obsessive compulsive disorder, autism,  
neuroprotection, cancer, depression and  
diabetes type

2.

417/2015

Chiesi Farmaceutici S.p.A., Italy.—“DRY  
POWDER INHALER AND INHALATION  
ACTUATED MECHANISM THEREOF”

A61M 15/00.

A flap (20) for an inhalation actuated  
mechanism (18) of a powder inhaler (1)  
comprises a base member (29), a skirt  
structure (24) projecting from a surface of  
the base member (29), and a coupling portion  
(21) to be coupled to a resilient member (40')  
of the inhalation actuated mechanism (18).

FIG. 2

98/2017

Tata Consultancy Services Limited, India.—  
“METHOD AND SYSTEM FOR EARLY RISK  
ASSESSMENT OF PRETERM DELIVERY  
OUTCOME”.

C12Q1/689 &amp; A61B 5/00.

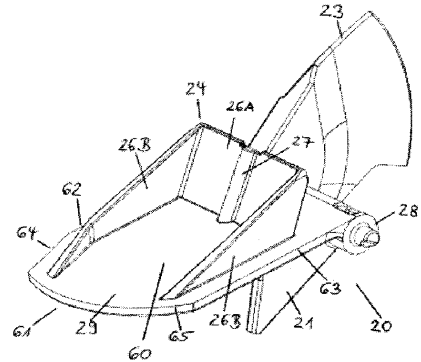
143393

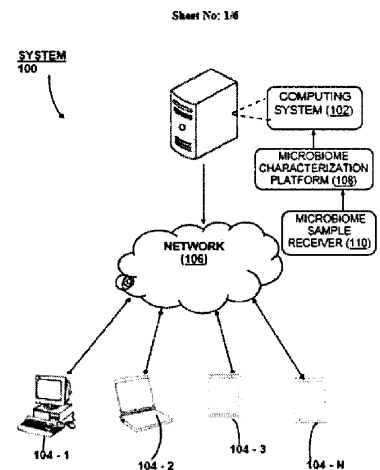

FIGURE 1

System and method for assessing preterm  
delivery risk for pregnant subject is disclosed.  
Existing preterm delivery risk assessment  
methods provide results in late second or  
third trimester of pregnancy, so little time  
is available for medical advice. Presently  
disclosed method and system predict  
preterm delivery risk within 15 weeks of  
pregnancy. Microbiome characterization data  
obtained from microbiome sample from  
pregnant subject. 'Microbial taxonomic  
abundance profile' generated from microbiome

characterization data, contains abundance values of microbes present in the microbiome sample. 'Taxonomic Composition Skew' value, and distribution characteristic value for 'microbial taxonomic abundance profile', quantifying biases in abundance values of microbes from the microbial taxonomic abundance profile, is computed. Risk of preterm delivery is determined based on the distribution characteristic value or 'taxonomic composition skew' value of the set 'DSR'(a set derived by computing  $(DT_j)$  (dominant Taxa)%STi (sparse taxa))for each ordered pair in the set 'C'), wherein the set DSR (a set derived by computing  $(DT_j)$  (dominant Taxa)%STi (sparse taxa))for each ordered pair in the set 'C') comprises values quantifying biases in the abundance values of microbes from the microbiome sample.

686/2017 Muhammad Kamil, Samina Iqbal, Kamran Abro, Alia Bano Munshi, Sofia Khalique Alvi, Shagufta Shaikh, Ghulam Fareed and Sheraz, Shafiq, Pakistan.—“A PROCESS FOR COMPLEX FORMATION BETWEEN COBALT(II) AND SCHIFF BASE LIGAND 2-[METHYLIMINO]METHYL] PHENOL, ITS PHYSIOCHEMICAL INVESTIGATIONS AND UTILIZATION AS ANTIFUNGAL AND ANTIBACTERIAL AGENT”.

143394

Cobalt (II) Complex derived from schiff base ligand containing nitrogen atom (N) electron pair donating atom to transition metal *i.e.* cobalt. Complex of cobalt was prepared by

the reaction of cobalt chloride Hexahydrate with Schiff base ligand 2-[(Methylimino)methyl]phenol in 1:1 molar ratio. Schiff base ligand was prepared by the reaction of salicylaldehyde with ethylamine. For complex formation 12.6271gm of Schiff base ligand and 20.1823 cobalt chloride hexahydrate has been used. Reaction between cobalt chloride Hexahydrate and above mentioned Schiff ligand was conducted in 250.0 ml flat bottom flask with constant stirring. After 45 minutes 10.0ml of methanolic solution of sodium hydroxide (1 molar) was added in reaction flask with the help of 10.0ml pipette in order to obtain basic pH which is more appropriate for complex formation then contents of the flask were refluxed for two hours. In the result of reaction between concerned chemicals the end product was a blue colour complex. Complex of cobalt was screened against E.Coli, S.typhi, S.aureus, B.subtilis and Ps. Aeruginosa.

#### **CORRIGENDUM**

In the Gazette of Pakistan Part V issued dated 6th January, 2020, under the heading “SEALING FEES DUE”. The following correction are as under :-

**PATENT NO. 143234**  
**APPLICATION NO. 565/2010**

(Due to opposition received in this above Application on 3rd January, 2020, the Application No. 143234 deleted in the list of sealing fees due only)

#### **NEW APPLICATIONS FOR THE INDUSTRIAL DESIGNS**

Design No.	Title & Class	Applicant
<b>9th December, 2019</b>		
20222	PCR Amplifier (Class 12)	Sansure Biotech INC.
20223	Nucleic acid detection and analysis instrument (Class 12)	Sansure Biotech INC.
20224	Articles composed wholly of paper, card-board, mill-board or straw board, or in which such materials predominate (Class 5)	BALMY TISSUE (SMC-PRIVATE) LIMITED
20225	Bottle (Class-03)	Syed Muhammad
<b>10th December, 2019</b>		
20226	Pen Nib (Class-01)	Sayyed Engineers Limited

<b>Design No.</b>	<b>Title &amp; Class</b>	<b>Applicant</b>
20227	Pen Nib (Class-01)	Sayyed Engineers Limited
20228	Pen Nib (Class-01)	Sayyed Engineers Limited
20229	Pen Nib (Class-01)	Sayyed Engineers Limited
20230	Pen Feeder (Class-03)	Sayyed Engineers Limited
20231	Pen Feeder (Class-03)	Sayyed Engineers Limited
20232	Pen Feeder (Class-03)	Sayyed Engineers Limited
20233	Pen Feeder (Class-03)	Sayyed Engineers Limited
<b>11th December, 2019</b>		
20234	Sinker cover for a circular knitting machine (Class-01)	SANTONI S.P.A.
20235	Sinker cover for a circular knitting machine (Class-01)	SANTONI S.P.A.
20236	Device for feeding threads to needles of a knitting machine (Class-01)	SANTONI S.P.A.
20237	Dial group for a circular knitting machine (Class-01)	SANTONI S.P.A.
20238	Knitting head for a circular knitting machine (Class-01)	SANTONI S.P.A.
<b>12th December, 2019</b>		
20239	Can (Class-03)	Sadar-Ud-Din Kurji,

**REGISTRATION OF DESIGNS**

The following designs have been registered.

S. No.	Design No.	Title & Class	Applicant
<b>12th December, 2019</b>			
1.	19763	DSA UNIVERSAL SPIDER MOUNT FOR MACHINE GUNS (Class-13)	MOHAMMED N. DAUD
2.	19765	DSA AGL PAK-40 AUTOMATIC GRENADE LAUNCHER 40MM (Class-13)	NOORUDDIN. F. DAUD
3.	19766	DSA MGL LV6 MULTI GRENADE LAUNCHER 40MM (Class-13)	MOHAMMED N. DAUD
4.	19767	DSA TRUSHOT 9MM PISTOL (Class-13)	MOHAMMED N. DAUD
5.	19768	DSA NINE 9MM PISTOL (Class-13)	HAKIMUDDIN DAUD
6.	19778	DSA SIGNAL / FLARE PISTOL 1 Inch (Class-13)	MOHAMMED N. DAUD

DR. MUHAMMAD FAYYAZ AHMAD,  
Controller of Patents & Registrar of Designs.





**PUBLISHED BY AUTHORITY**

**KARACHI, WEDNESDAY, OCTOBER 7, 2020**

## **PART VI**

**Advertisements and Notices issued by Corporate Bodies and  
Private Individuals on payment**

**PAKISTAN STOCK EXCHANGE LIMITED**

NOTIFICATION

Date: September 8, 2020

In exercise of powers conferred upon Securities and Exchange Commission of Pakistan (SECP) under Section 8(1) of the Securities Act, 2015, Pakistan Stock Exchange Limited (PSX), with the prior approval of the SECP, hereby makes the following amendments to PSX Regulations in relation to revision of listing fee for equity securities and insertion of a power for PSX to relax any listing requirement(s) of Chapter 5B [Listing of Debt Securities Regulations] of PSX Regulations. These approved amendments have taken effect from July 01, 2020.

### **Chapter 5: LISTING OF COMPANIES AND SECURITIES REGULATIONS**

1. Sub-clause 5.19.1 (b) and (c) of PSX Regulations has been amended to read as under:

#### **5.19. LISTING AND ANNUAL FEES:**

##### **5.19.1.LISTING FEE SCHEDULE:**

- (b) Whenever, a listed company increases the paid-up capital of any class or classes of its shares, or securities listed on the Exchange, it shall pay to the Exchange a fee equivalent to 0.2% of increase in Paid-up Capital.
- (c) Every listed company shall pay, in respect of each financial year of the Exchange, commencing from 1st July and ending on 30th June next, an annual listing fee calculated on the basis of the company's \*market capitalization, in accordance with following schedule, subject to a maximum of Rupees five million:

\* Explanation: For the purpose of this sub-clause, the market capitalization shall be calculated by multiplying the last one year's volume weighted average price with the company's outstanding ordinary shares as on June 30, of the preceding year.

Rate of Fee applicable with effect from July 01, 2020:

<b>COMPANIES HAVING MARKET CAPITALIZATION AS ON JUNE 30</b>	<b>RATE OF FEE PER ANNUM</b>
Up to Rs. 100 million	Rs. 100,000
Above Rs.100 million & up to Rs. 250 million	Rs. 100,000+0.075% on excess over Rs.100 million

COMPANIES HAVING MARKET CAPITALIZATION AS ON JUNE 30	RATE OF FEE PER ANNUM
Above Rs.250 million & up to Rs. 500 million	Rs. 212,500+0.06% on excess over Rs.250 million
Above Rs.500 million & up to Rs. 1,000 million	Rs. 362,500+0.025% on excess over Rs.500 million
Above Rs.1,000 million & up to Rs. 2,000 million	Rs. 487,500+0.015% on excess over Rs.1,000 million
Above Rs.2,000 million & up to Rs. 10,000 million	Rs. 637,500+0.013% on excess over Rs.2,000 million
Above Rs.10,000 million & up to Rs. 20,000 million	Rs. 1,677,500+0.005% on excess over Rs.10,000 million
Above Rs.20,000 million & up to Rs. 50,000 million	Rs. 2,177,500+0.0015% on excess over Rs.20,000 million
Above Rs.50,000 million	Rs. 2,627,500+0.001% on excess over Rs.50,000 million

Provided that in case of Open-Ended Mutual Funds, the annual listing fee of PKR 25,000 shall be payable in respect of each financial year of the Exchange, commencing from 1st July and ending on 30th June next, before the 30th September, in each calendar year.

Provided further that the Board may revise the above fees or any of the slabs or add new slabs with the approval of the Commission.

Provided further that every company applying for listing shall not be charged annual listing fee for twelve (12) months from the date of its listing.

2. Serial No.30 of Appendix-I of Chapter 5 of PSX Regulations has been amended to read as under:

#### APPENDIX-I

#### DOCUMENTS TO BE SUBMITTED WITH LISTING APPLICATION

The following documents and information shall be submitted by the applicant company to the Exchange along with application for listing under Sub-Regulation (a) of Regulation 5.2.1:

30. Payment of applicable fee and charges at the rate as mentioned in Regulation No.5.19. in favor of the Exchange.

#### Chapter 5B: LISTING OF DEBT SECURITIES REGULATIONS

3. Clause 5B.16. of PSX Regulations has been newly inserted to read as under:

#### 5B.16. RELAXATION:

Where the Exchange is satisfied that it is not practicable to comply with any listing requirement(s) of this Chapter in a particular case or class of cases, or is necessary for development of debt capital market, the Exchange may, for reasons to be recorded, relax such requirement(s) subject to such conditions as it may deem fit. The Exchange shall also intimate the Commission in writing regarding any such relaxation within three working days of granting the same.

ABBAS MIRZA,  
GM & Acting Chief Regulatory Officer,  
Pakistan Stock Exchange Limited.

**PAKISTAN STOCK EXCHANGE LIMITED**

## NOTIFICATION

Date: September 8, 2020

In exercise of powers conferred upon Securities and Exchange Commission of Pakistan (SECP) under Section 8(3) of the Securities Act, 2015, Pakistan Stock Exchange Limited (PSX), with the prior approval of the SECP, hereby makes the following amendments to PSX Regulations in relation to market making of Debt Securities. These approved amendments shall take effect from the date of submission of approved amendments to be notified in the official Gazette of Pakistan *i.e.* September 08, 2020.

**Chapter 5A: REGULATIONS GOVERNING LISTING AND TRADING OF EQUITY SECURITIES ON GROWTH ENTERPRISE MARKET**

1. Clause 5A.1.1 (m) of PSX Regulations has been amended to read as under:

**5A.1. DEFINITIONS:**

5A.1.1. In this Chapter, unless the subject or context otherwise requires:

- (m) "Market Maker" has the same meaning of Designated Market Maker as defined in chapter 2 of these Regulations;

2. Clause 5A.1.1 (r) of PSX Regulations has been deleted:

3. Clause 5A.8 of PSX Regulations has been amended to read as under:

**5A.8. APPOINTMENT AND FUNCTIONS OF MARKET MAKERS:**

If deem appropriate and required, the issuer may appoint a Market Maker, through an agreement in writing for market making of respective equity security.

Chapter 12 of these Regulations shall apply to the matters relating to appointment and functions of Market Makers in GEM.

**Chapter 5B: LISTING OF DEBT SECURITIES REGULATIONS**

4. Existing clauses 5B.2.1 (i), 5B.4.3 and 5B.11 of PSX Regulations have been deleted.

5. Serial No. (xviii) and (xix) of Annexure-I of Chapter 5B of PSX Regulations have been deleted:

**Chapter 5C: PRIVATELY PLACED DEBT SECURITIES' LISTING REGULATIONS**

6. Sub-clause 5C.2.1. (v.a) has been newly inserted:

**5C.2. DEFINITIONS:**

5C.2.1. In this Chapter, unless the subject or context otherwise requires:

- (v.a) Issuer shall have the same meaning as defined in Public Offering Regulations, 2017.

7. Sub-clause 5C.3.(i) of PSX Regulations has been deleted and sub-clauses 5C.3 (ii) - (vii) have been consequentially re-numbered as 5C.3 (i) - (vi).

8. Sub-clause 5C.4 (iii) of PSX Regulations has been deleted, sub-clauses 5C.4 (iv) - (xi) have been consequentially re-numbered as 5C.4 (iii) - (x) and proviso to 5C.4 (ii) has been amended to read as under:

**5C.4. CONDITIONS FOR LISTING:**

A company intending to list its debt securities under this Chapter shall comply with the following conditions:

- (ii) the Debt Securities Trustee so appointed may retire from its office on appointment of a new Debt Securities Trustee and the retirement shall take effect at the same time as the new Debt Securities Trustee is appointed.

Provided that the clause (i) shall not apply in case where debt security is issued by the company having instrument rating of A and above or where the debt security is backed by debt servicing guarantee from the GOP.

- 9. Clause 5C.8 (xii) of PSX Regulations has been deleted.
- 10. Serial No. xiii of Annexure-I of Chapter 5C of PSX Regulations has been amended to read as:

**Annexure-I****DOCUMENTS AND INFORMATION REQUIRED TO BE SUBMITTED ALONGWITH APPLICATION FOR LISTING OF A DEBT SECURITY UNDER CHAPTER 5C OF THESE REGULATIONS.**

A company applying for listing of its debt security under this Chapter shall provide the following documents and information:

- xiii. Consent letter from the Consultant to the Issue, if any, Legal Advisor to the Issue, if any, Debt Securities Trustee, where required and Shariah Advisor, where required,

- 11. Serial No. 22 of Annexure-II of Chapter 5C of PSX Regulations has been deleted:

**Chapter 6: GOVERNMENT DEBT SECURITIES (GDS) MARKET REGULATIONS**

- 12. Clause 6.1. (k), (l) and (m) of PSX Regulations have been deleted.
- 13. Clause 6.3 of PSX Regulations has been amended to read as under:

**6.3. TRADING PARTICIPANTS:**

The following shall be eligible to become Trading Participants to trade in Government Debt Securities in GDS Market on BATS Through Trading Work Stations provided by the Exchange:

- (a) All Securities Brokers that have access to trade in equity securities on KATS eligible to participate in the GDS Market of the Exchange for trading in their Proprietary Accounts or in the accounts of the Eligible Clients having IPS Accounts and/or Cash Accounts with any Clearing Participant;
- (b) All Commercial Banks registered with SBP.

- 14. Clauses 6.10.6.11.6.16 and Schedule-I of Chapter 6 of PSX Regulations have been deleted.

**Chapter 12: MARKET MAKERS REGULATIONS**

- 15. Sub-Clause 12.5.2. of PSX Regulations has been deleted.

**Chapter 12A: MARKET MAKERS REGULATIONS FOR LISTED DEBT SECURITIES INCLUDING GOVERNMENT DEBT SECURITIES.**

- 16. Chapter 12A titled as "Market Makers Regulations for Listed Debt Securities including Government Debt Securities" has been newly inserted in PSX Regulations:

**12A.1. DEFINITIONS:**

In this chapter, unless the subject or context requires otherwise:

- (a) "Ask Price" means the price at which the Market Maker is willing to sell a listed debt Security.
- (b) "Bid Price" means the price a Market Maker is willing to pay for the purchase of listed debt security.
- (c) "Eligible Entities" means that entities that are eligible to act as Market Maker for listed debt securities.
- (d) "Market Maker Agreement" shall mean an agreement executed between the Market Maker and the Exchange to perform market making activities under this chapter.
- (e) "Market Maker" means a person eligible under this chapter to undertake Market Making in listed debt securities including GDS.
- (f) Market Making means quotation of bid and ask price by a Market Maker to create liquidity in listed debt securities including GDS.

**12A.2. APPLICABILITY:**

These Regulations shall be applicable for Market Making of listed Debt Securities including Government Debt Securities.

**12A.3. ELIGIBILITY OF MARKET MAKER:**

The following entities can apply to the Exchange for appointment as Market Maker for one or more listed Debt Securities:

- (a) A Securities Broker licensed by the Commission. OR
- (b) A Scheduled Bank. OR
- (c) A Development Financial Institution. OR
- (d) An Asset Management Company for and on behalf of a Collective Investment Scheme as defined under the Non-Banking Finance Companies and Notified Entities Regulations, 2008. OR
- (e) Investment Finance Services license holder (IFS). OR
- (f) Primary Market Dealers (PDs) registered with the State Bank of Pakistan for market making of Government Debt Securities. OR
- (g) Any other Company notified by the Commission.

Provided that above entities must hold valid respective license(s).

The Eligible Entities shall be connected with the Trading System of the Exchange for performing market making activities on such terms and conditions as may be prescribed by the Exchange from time to time.

**12A.4. PROCEDURE FOR APPOINTMENT AS MARKET MAKER:**

12A.4.1 For appointment as Market Maker, the Eligible Entities shall apply to the Exchange by submitting an application specifying the name of listed Debt Securities for which they want to act as Market Maker.

Provided further, that Eligible Entities can act as Market Makers for one or more listed Debt Securities.

Provided that PDs shall only be required to inform the Exchange about the listed Debt Securities for which it wants to act as Market Maker.

12A.4.2 The Exchange, on being satisfied that the entity holds valid license/ registration from their respective regular/ organization, may allow it in writing to act as Market Maker by executing Market Making Agreement.

Provided further that Market Maker can add/ remove any listed Debt Security for market making in Market Making Agreement with the Exchange.

Provided that in case of PDs, formal Market Making Agreement shall not be applicable. PDs shall only intimate the listed debt securities (in addition to GDS) for which they shall be performing the role of Market Maker.

Provided further that requirement of Market Making Agreement shall be applicable on PDs only if the PDs does not quote bid and ask price on daily basis in Government Debt Securities through Securities Exchange Trading System.

#### **12A.5. ROLES AND RESPONSIBILITIES OF MARKET MAKER:**

The Market Maker shall:

- (a) daily quote on Exchange Trading System, the bid and ask price along with number of listed debt securities that it is willing to buy or sell at that price.
- (b) report any off Market Transactions executed by it with other Market Makers to the Exchange through electronic mode at the end of each trading day for placement on PSX website.
- (c) ensure that the System provided by the Exchange for performing market making activities shall only be used for market making.
- (d) follow the Market Maker Code of Conduct prescribed by the Exchange, which is shared with each Market Maker upon joining and published on the Exchange's website, as amended from time to time.
- (e) be allowed to execute Blank Sale subject to the condition that sufficient Pre-Existing Interest exists in the account(s) of Market Maker at the end of each Blank Sale day to validate that the Market Maker can deliver the quantity sold blank during the trading day, failing which the NCCPL shall have the right to impose additional margin on such Market Maker.
- (f) be allowed to execute Blank Sale as per Clause (e) maximum up to such limit as may be specified by the Exchange in consultation with NCCPL.
- (g) be allowed to execute Blank Sale as per Clause (e) and (f) above, without Up-Tick or Zero-Plus Tick up to the following extent:
  - i. Broker-Wide Position: Maximum up to such limit as may be specified by the Exchange in consultation with NCCPL.
  - ii. Market-Wide Position (All Market Makers on cumulative basis): Maximum up to such limit as may be specified by the Exchange in consultation with NCCPL.
- (h) notify to the Exchange immediately regarding suspension, cancellation or revocation of license by the respective licensing authority.

#### **12A.6. ASSESSMENT OF PERFORMANCE:**

12A.6.1. The Exchange shall assess from time to time and at least quarterly the performance of Market Makers based on the performance assessment criteria prescribed by the Exchange from time to time.

12A.6.2. Based on the assessment of the performance, the Exchange may cancel the market making agreement.

#### **12A.7. SUSPENSION OR CANCELLATION OF MARKET MAKING AGREEMENT/APPOINTMENT:**

The Exchange may restrict, suspend or revoke the Market Maker's appointment for any or all listed Debt Securities for which it is acting as the Market Maker or attach such additional terms or conditions to the Market Maker as the Exchange deems to be necessary, where:

- (a) the Market Maker fails to comply with any term of the Market Making Agreement, Market Maker Code of conduct, these Regulations, any other requirement(s) prescribed by the Exchange,
- (b) the Exchange has determined that the Market Maker or its officers, employees, directors or agents have in any way acted in a manner that is detrimental to the interests of the Exchange or the public.

The Exchange shall disseminate to the market as soon as possible the information relating to imposition of restriction, suspension or revocation of appointment of Market Maker.

The Exchange may suspend or terminate a Market Maker's responsibilities where a corporate action or other unusual circumstance makes it impractical for the Market Maker to carry out its responsibilities.

Provided that the ordinary market volatility will not be considered to be an "unusual circumstance" for the purposes of this clause.

#### **12A.8. NOTIFICATION:**

12A.8.1. A Market Maker must give the Exchange at least 3 days' prior written notice that it intends to relinquish its responsibilities for a particular listed Debt Security or add any new listed debt security in its Market making portfolio.

Provided that for any addition/ deletion in market making portfolio an addendum to the Market Making agreement shall be issued.

Provide further that in case of PDs, where market making agreement is not applicable there is no need for an addendum, they just have to inform the Exchange about the change in market making portfolio.

The Exchange may also make the above provisions part of Market Maker Agreement.

ABBAS MIRZA,  
GM & Acting Chief Regulatory Officer,  
Pakistan Stock Exchange Limited.

---

### **PAKISTAN STOCK EXCHANGE LIMITED**

#### **NOTIFICATION**

Date: September 10, 2020

In exercise of powers conferred upon Securities and Exchange Commission of Pakistan (SECP) under Section 8 of the Securities Act, 2015, Pakistan Stock Exchange Limited (PSX), with the prior approval of the SECP, hereby makes the following amendments to PSX Regulations in relation to opening of an account of Non-Resident Pakistani by a broker maintaining Non-Resident Pakistani Rupee Value Account with the designated bank in Pakistan. These approved amendments have taken effect immediately from the date of Letter of approval *i.e.* August 18, 2020.

#### **Chapter 4: Trading Rights Entitlement (TRE) Certificate**

##### **1. Clause 4.1. of PSX Regulations has been newly inserted:**

#### **4.1. DEFINITIONS:**

4.1.1. In this Chapter, unless there is anything repugnant in the subject or context:

- (a) "NRP Rupee Value Accounts (NRVA)", shall have the same meaning as ascribed thereto in the Foreign Exchange Manual of State Bank of Pakistan;
- (b) "Non-Resident Pakistani (NRP)", shall have the same meaning as ascribed thereto in the Foreign Exchange Manual promulgated by State Bank of Pakistan.
- (c) "NRVA Information", shall have the same meaning as defined in the CDC Regulations and represents the information received from CDC or a scheduled Bank or obtained in any other manner as prescribed in the procedures, by the Securities Broker for the purposes of opening of account of a customer who is a NRP.

**2. Existing clause 4.1. of PSX Regulations has been re-numbered as 4.1A.**

**3. Sub-clause 4.15.1 of PSX Regulations has been amended to read as under:**

**4.15. MAINTENANCE OF A CUSTOMER RELATIONSHIP FORM (“CRF”) AND SAHULAT KYC APPLICATION/ ACCOUNT OPENING FORM (“SAHULAT FORM”):**

4.15.1. The Securities Brokers shall adopt the CRF attached as Annexure-I to this chapter, as amended from time to time, and the know Your Customer Application Form specified in the Centralized know Your Customer Organization Regulations, 2017 by NCCPL for all their Customers.

Provided that the Securities Brokers may open sahulat accounts for individuals indentified as low risk customers as per applicable laws and regulations and adopt Sahulat Form for such customers as notified by the Exchange together with relevant terms and conditions from time to time with the prior approval of the Commission.

Provided further that the Securities Brokers may open an account of NRP who maintains NRVA with the designated bank in Pakistan, in such manner and based on such terms and conditions as prescribed in the procedures specified by the Exchange and as amended from time to time. For the purpose of establishment of such account, NRVA Information and any additional information, as may be prescribed in the procedures, shall be used in place of Customer Relationship Form, or, as the case may be, the Sahulat Account Opening Form and/or the KYC Application Form and the requirement of obtaining such forms will be dispensed with. The Securities Brokers shall be required to separately maintain the list of such accounts alongwith supporting documents and correspondences made with such customers in their records.

Provided further that all other requirements prescribed under these PSX Regulations and any other relevant regulations or notification relating to opening of account and subsequent dealing between Securities Broker and customers shall be applicable on accounts opened for NRP under this clause, except as is otherwise specified in the procedures.

Provided further that where an account of NRP is opened by the Securities Broker on the basis of NRVA Information and any additional information as may be prescribed in the procedures, such information or any subsequent updations (if any) shall be deemed to have been entered with the authorization and consent of such customer.

Provided further that terms of the Customer Relationship Form, the KYC Application Form or, as the case may be, the Sahulat Account Opening Form referred under these Regulations, shall be read as NRVA Information and any additional information as may be prescribed in the procedures for the purpose of NRP.

ABBAS MIRZA,  
GM & Acting Chief Regulatory Officer,  
Pakistan Stock Exchange Limited.