



# The Gazette of Pakistan

PUBLISHED BY AUTHORITY

No. 29]

KARACHI, WEDNESDAY, JULY 15, 2020

## CONTENTS

	PAGES		PAGES
<b>PART I—</b> Notifications regarding appointments, promotions, etc., issued by Ministries/Divisions of the Government of Pakistan, Department of the Auditor-General of Pakistan and the Supreme Court of Pakistan other than the Ministry of Defence and Ministry of Defence Production .....	807—823	<b>PART IV—</b> Notifications issued by the minor administrations and miscellaneous notification not included in any other part .....	41—42
<b>PART II—</b> Notifications issued by the Ministry of Defence and Ministry of Defence Production	333—343	<b>PART V—</b> Notifications etc., issued by The Patent Office.	13—25
<b>PART III—</b> Notifications issued by the High Courts, the Federal Public Service Commission and by the Attached and Subordinate Offices of the Government of Pakistan .....	573—591	<b>PART VI—</b> Advertisements and Notices issued by Corporate Bodies and Private Individuals on payment .....	—Nil—
		<b>SUPPLEMENT NO.</b>	
		Weekly, notification of cases and deaths from quarantiable diseases .....	

## PART I

## Notifications regarding appointments, promotions, etc. issued by Ministries/Divisions of the Government of Pakistan, Department of the Auditor-General of Pakistan and the Supreme Court of Pakistan other than the Ministry of Defence and Ministry of Defence Production

PRESIDENT'S SECRETARIAT (PERSONAL)

Islamabad, the 7th July, 2020

**No. 514(1)-Admn/2020.**—Consequent upon approval of competent authority *i.e.* Military Secretary to the President, Mr. Muhammad Yar Kalyar, Security Supervisor (BPS-16) of this Secretariat is hereby allowed to serve during the period of LPR and to draw encashment in lieu of LPR for the last 365 days with effect from 13th April, 2020 to 12th April, 2021 (both days inclusive) as per admissibility under the rules.

The officer shall stand retired from Govt. Service with effect from 12th April, 2021 (A.N) and struck off the strength of this Secretariat with effect from the same date.

MUHAMMAD FAISAL, *Lt. Col.*  
Deputy Military Secretary to the President.

PRESIDENT'S SECRETARIAT (PUBLIC)

Islamabad, the 7th July, 2020

**No. F.3(233)/2009-Estt.**—In pursuance of Establishment Division's Notification No.F.39/1057/2017-E-1, dated

29th June, 2020, Mr. Zulfiqar Hussain Awan, a BS-20 Officer of Secretariat Group has relinquished the charge of the post of Director General (BS-20) with effect from 19th June, 2020.

SHAMIM SHAMSHAD,  
Director (Admn).

PRIME MINISTER'S OFFICE

[BOARD OF INVESTMENT]

Islamabad, the 2nd July, 2020

**No. 3(203)-HR/2019.**—In pursuance of Establishment Division's Notification No.PF(597)/E-5(PAS), dated 30th June, 2020, Mr. Omer Rasul, a BS-22 Officer of Pakistan Administrative Service, has relinquished the charge of the post of Secretary (BS-22), Prime Minister's Office, Board of Investment, Islamabad with immediate effect and until further orders.

MUHAMMAD NAEEM,  
Deputy Director (HR).

(807)

## NATIONAL ACCOUNTABILITY BUREAU

## CABINET SECRETARIAT

Islamabad, the 1st July, 2020

(Cabinet Division)

**No. 3(62)/P/2002/Admn-I.**—This Bureau's notification of even number dated 28th January, 2020, regarding 15 days leave *ex-Pakistan* (LFP) from 27th January, 2020 to 10th February, 2020, in respect of Syed Muhammad Hasnain, Addl. Director (BS-19), NAB (Lahore) may please be treated as cancelled/ withdrawn.

This issues with the approval of Chairman NAB.

SYED IZHAR HUSSAIN SHAH,  
Deputy Director (PM-V).

\_\_\_\_\_

Islamabad, the 6th July, 2020

**No. 3(184)/P/2004/Admn-I.**—Chairman NAB has been pleased to approve 12 days leave with full pay in respect of Mirza Sultan Muhammad Saleem, Director (BS-20), National Accountability Bureau (HQ), Islamabad with effect from 29th June, 2020 to 10th July, 2020.

On expiry of leave, the officer shall resume his duties at the same post.

MUHAMMAD SHOAIB,  
Deputy Director (PM-I).

\_\_\_\_\_

Islamabad, the 3rd July, 2020

**No. 3(230)/F/2004/Admn-I.**—The Chairman NAB has been pleased to grant 05 days earned leave with full pay (LFP) in respect of Mr. Farman Ullah, Director General, own pay & scale (OPS), NAB (Balochistan), Quetta with effect from 29th June, 2020 to 3rd July, 2020.

On the expiry of leave, the officer shall resume his duties of the same post and station.

Islamabad, the 6th July, 2020

**No. 3(1371)/S/2013-PM-III.**—Consequent upon her selection in Provincial Management Services (PMS/BPS-17) in Government of Sindh through Combined Competitive Examination 2018, Ms. Rabia Abdul Rehman, Assistant Director (BPS-17) NAB (Karachi) is hereby relieved from NAB with immediate effect to join her new assignment.

She is granted "Right of Reversion" against her temporary post of Assistant Director (BPS-17) for a period of one (1) year with effect from date of relieving from NAB (Karachi).

HAMZA NIHAL TARIQ,  
Assistant Director (PM-III).

Islamabad, the 2nd July, 2020

**No. 4/1/2019-R-A-II/OGRA.**—The Prime Minister has been pleased to constitute the following Selection Committee for Selection of Chairman and Member (Oil), Oil and Gas Regulatory Authority (OGRA) under the administrative control of the Cabinet Division:-

- |      |   |          |
|------|---|----------|
| i)   | Mirza Shahzad Akbar, SAPM<br>on Accountability and Interior | Chairman |
| ii)  | Cabinet Secretary   | Member   |
| iii) | Mr. Zafar I. Usmani   | Member   |
| iv)  | Mr. Najamul Kamal Hyder                                     | Member   |
| v)   | Mr. Aftab Hussain   | Member   |

2. The ToRs of the Committee have been determined *vide* Establishment Division's O.M. No.F.1/29/2018-E-6 dated 28th March, 2019.

SYED HASSAN MAHMOOD,  
Joint Secretary.

\_\_\_\_\_

Islamabad, the 1st July, 2020

**No. PF.(1023)-Admn-II.**—In continuation of this Division's notification of even number dated 15th June, 2020 and with the approval of Cabinet Secretary, Mr. Muhammad Akram, Joint Secretary (Lit. Devo), (BS-20), Cabinet Division is granted 07 days extension in leave on full pay (LFP) with effect from 23rd June, 2020 to 29th June, 2020, under the Revised Leave Rules 1980, subject to title.

On expiry of leave, the officer is likely to resume his duties on the same post and station.

SARDAR MEHMOOD,  
Section Officer (Admn-II).

\_\_\_\_\_

(Aviation Division)

Islamabad, the 17th June, 2020

**No. F.1-11/2020-Admin.**—Mr. Ghafoor Shah, Superintendent (BPS-16) has been granted Current Charge of the post of Section Officer (Flying) for a period of three (03) months with effect from 22nd May, 2020 or till the posting of a regular Section Officer whichever is earlier.

**No. F.1-11/2020-Admin.**—Mr. Mudassir Bashir, Superintendent (BPS-16) has been granted Current Charge of the post of Section Officer (PAC/Council) for a period of three (03) months with effect from 8th June, 2020 or till the posting of a Regular Section Officer whichever is earlier.

SHEIKH NOOR MUHAMMAD,  
Deputy Secretary (Admin).

Islamabad, the 2nd July, 2020

**No. F.2-3/2020-Admin.**—In pursuance of Establishment Division's Notification No.39/1038/2015-E-I dated 17th June, 2020, Mr. Muhammad Arshad Khan, a BS-20 Officer of Secretariat Group has assumed the charge of the post of Joint Secretary (BS-20), in Aviation Division, Islamabad with effect from 30th June, 2020.

SAEED AKHTER KHAN,  
Section Officer (Admin).

Islamabad, the 6th April, 2020

**No. 1/9/2018/Met.**—Consequent upon the recommendation of the Departmental Promotion Committee made in its meeting held on 19th February, 2020 at Aviation Division, Islamabad, Mr. Tanveer Ali Agha, Meteorologist (BS-17) stands promoted to the post of Deputy Director/Sr. Meteorologist (BS-18) with effect from 19th March, 2020.

SALEEM AHMAD KHAN,  
Section Officer.

Islamabad, the 1st July, 2020

**No. 1/3/2020/Met.**—Mr. Muhammad Aslam, Director (BS-19), Flood Forecasting Division, Pakistan Meteorological Department, Lahore is granted additional charge of the post of Director (BS-19), Regional Meteorological Centre, Lahore with immediate effect for an initial period of three months or till the posting of a regular officer whichever is earlier.

**No. 1/3/2020/Met.**—In pursuance of the recommendations of office of the Ombudsperson (Mohtasib), Punjab in Case No.WOP/11-260/2020/17, dated 4th January, 2019, Mr. Muhammad Ajmal Shad, Director (BS-19) Regional Meteorological Centre, Lahore is transferred and posted as Director (BS-19) in Geophysical Centre, Quetta with immediate effect and until further orders.

SEHRISH MAZARI,  
Section Officer.

(Establishment Division)

Islamabad, the 14th April, 2020

**No. 6/1/2007-D-2.**—The office timings notified *vide* this Division's notification of even number dated 25th March, 2020 shall continue until the commencement of the Holy Month of Ramzan, unless modified or withdrawn earlier.

SAEED ASHRAF SIDDIQI,  
Joint Secretary.

Islamabad, the 26th March, 2020

**No. PF(874)/E-5(PAS).**—Mr. Javed Akhter Mahmood, a BS-20 Officer of Pakistan Administrative Service, presently posted under Government of Balochistan, is transferred and his services are placed at the disposal of Government of the Punjab, with immediate effect and until further orders.

**No. PF(926)/E-5(PAS).**—Mr. Jawad Akram, a BS-19 Officer of Pakistan Administrative Service, presently posted under Government of Gilgit-Baltistan, is transferred and directed to report to Establishment Division, with immediate effect and until further orders.

Islamabad, the 1st June, 2020

**No. PF(572)/E-5(PAS).**—Mr. Zafar Hasan, a BS-22 Officer of Pakistan Administrative Service, presently posted as Secretary, Communications Division, is assigned additional charge of the post of Secretary, Planning, Development and Special Initiatives Division, for a period of three months or till the posting of a regular incumbent, whichever is earlier.

**No. F.40/610/2018-E-I.**—Mr. G. Hassan Baig, a BS-21 Officer of Secretariat Group, presently posted as Officer on Special Duty (OSD), Establishment Division, is transferred and posted as Director General, National Commission for Human Development (NCHD), on deputation basis, for an initial period of three (03) years, on standard terms and conditions, with immediate effect and until further orders.

**No. F.39/979/2013-E-I.**—Mr. Muhammad Khurshid, a BS-20 Officer of Secretariat Group, presently awaiting posting in Establishment Division, is transferred and posted as Executive Director General (EDG) (PC-21), Privatisation Commission, under Section 10 of Civil Servants Act, 1973, with immediate effect, till the date of his superannuation *i.e.* 11th April, 2021 or till further orders, whichever is earlier.

Islamabad, the 2nd June, 2020

**No. PF(594)/E-5(PAS).**—Sardar Ajaz Ahmad Khan Jaffar, a BS-22 Officer of Pakistan Administrative Service, presently posted as OSD, Establishment Division, is transferred and posted as Secretary, Religious Affairs and Interfaith Harmony Division, with immediate effect and until further orders.

**No. 1/278/2017-E-4.**—Mr. Aqeel Ahmed Siddiqui, a BS-20 Officer of Inland Revenue Service (IRS), presently posted as Director General (Operations) (BS-20), Employees' Old-Age Benefits Institution (EOBI) under Ministry of Overseas Pakistanis and Human Resource Development, on deputation basis, is repatriated to his parent department with immediate effect.

**No. PF(1061)/E-5(PAS).**—The unavailed portion of leave on half average pay (*ex-Pakistan*) with effect from 10th September, 2019 to 9th September, 2020 granted to Ms. Saima Ali, a BS-18 Officer of Pakistan Administrative Service *vide* this Division's notification of even number dated 2nd September, 2019, is hereby cancelled with effect from 14th May, 2020.

**No. PF(1116)/E-5(PAS).**—Mrs. Foqia Danyal, a BS-18 Officer of Pakistan Administrative Service, presently posted under Government of Balochistan, is granted study leave (ex-Pakistan) for a period with effect from 15th June, 2020 to 15th December, 2021.

On completion of study leave, she will report to Establishment Division.

She is also granted *ex-post facto* approval for study leave (ex-Pakistan) with effect from 1st July, 2018 to 28th February, 2019.

Government of Pakistan has no objection on her proceeding abroad subject to the condition that there will be no foreign exchange liability on the part of Government of Pakistan during her travel, study and stay abroad.

Islamabad, the 3rd June, 2020

**No. PF(657)/E-5(PAS).**—The President of Islamic Republic of Pakistan has been pleased to approve the appointment / posting of Ms. Humaira Ahmed, a BS-21 Officer of Pakistan Administrative Service, presently posted as Additional Secretary, President's Secretariat as Secretary, Federal Public Service Commission, under Section 10 of the Civil Servants Act, 1973, with immediate effect, in terms of Regulation-12 of Federal Public Service Commission (Composition and Condition of Service) Regulations, 1978.

**No. F.12(20)/99-E-3(Police).**—Mr. Amir Farooqi, a BS-20 Officer of Police Service of Pakistan, presently serving under Government of Sindh, is transferred and directed to report to Establishment Division, with immediate effect and until further orders.

**No. PF(1047)/E-5(PAS).**—Ms. Nabila Irfan, a BS-18 Officer of Pakistan Administrative Service, presently awaiting posting in Establishment Division, is transferred and her services are placed at the disposal of Government of the Punjab, with immediate effect and until further orders.

**No. 1/55/2016-E-6.**—The competent authority has been pleased to accept the resignation of Malik Ahmed Khan, Member (Infrastructure & Regional Connectivity), Ministry of Planning, Development & Special Initiatives with effect from 25th February, 2020.

Islamabad, the 5th June, 2020

**No. PF(638)/E-5(PAS).**—The competent authority has been pleased to grant move over to Major (Retd.) Azam Suleman Khan, a BS-22 Officer of Pakistan Administrative Service, presently posted as Secretary, Interior Division, from BS-18 to BS-19 with effect from 1st December, 1993.

**No. F.1-82/2012-E-2.**—Mr. Shakeel Qaiser Kayani (SG/BS-19), presently posted as Deputy Secretary, Inter-Provincial Coordination (IPC) Division is transferred and placed at the disposal of National Vocational and Technical Training Commission (NAVTTTC), on deputation basis for a period of three years on standard terms and conditions, with immediate effect and until further orders.

**No. F.1-6/2012-E-2.**—Mr. Khaleeq-ur-Rehman (SG/BS-19), presently at the disposal of Establishment Division, is transferred and posted as Deputy Secretary, Establishment Division, with immediate effect and until further orders.

**No. 4/62/2009-E-4.**—Gp. Capt. Mr. Toqeer Ahmad (Pak-10985/GD(P) is appointed as Senior Additional Director (Ops), Aircraft Accident and Investigation Board (AAIB) on secondment basis as relief of Gp. Capt. Mirza Aamir Walayat (Pak-11280/GD(P) on standard terms and conditions as contained in JSI 4/85.

MARIAM KAYANI,  
Deputy Secretary.

Islamabad, the 3rd June, 2020

**No. PF.1081/2011-E-VII.**—The deputation period of Mr. Muhammad Kashif (OMG/BS-18/Acting Charge), presently at the disposal of Government of the Punjab is extended for a period of one year with effect from 19th May, 2020.

Islamabad, the 4th June, 2020

**No. PF.1552/2019-E-VII.**—Consequent upon his appointment through Khyber Pakhtunkhwa Public Service Commission (KPPSC), as officer of Provincial Management Services (PMS), Khyber Pakhtunkhwa, Mr. Luqman (OMG/BS-17/Probationer/ Undertraining), is hereby relieved, without lien from Office Management Group (OMG), with immediate effect.

SHAMS-UD-DIN,  
Section Officer.

Islamabad, the 4th June, 2020

**No. PF(743)/E-5(PAS).**—Mr. Mohyuddin Ahmad Wani, a BS-21 Officer of Pakistan Administrative Service, presently posted in National Disaster Risk Management Fund, is transferred and posted as Additional Secretary, Federal Education and Professional Training Division, with immediate effect and until further orders.

EJAZ AHMAD,  
Section Officer.

Islamabad, the 4th June, 2020

**No. 1/63/2009-E-6.**—The Federal Government has been pleased to approve the extension in additional charge of the post of Executive Director, Frequency Allocation Board (FAB) to Brigadier Musharaf Khan, Director General, National Frequency Management and Monitoring System (NFMMS), FAB under Cabinet Division for a further period

of two (02) months and twenty (20) days with effect from 1st May, 2020 to 20th July, 2020 (*i.e.* the date of expiry of appointment tenure of suspended ED, FAB).

MUHAMMAD SOHAIB,  
Section Officer.

Islamabad, the 4th June, 2020

**No. 1-35/2010-E-2.**—In partial modification of notification of even number dated 2nd April, 2018, regarding transfer of Mr. Tariq Mahmood, a BS-19 Officer of the Secretariat Group, is hereby withdrawn *ab-initio*.

**No. F.1-39/2012-E-2.**—Mr. Mustaeen Ahmed Alvi (SG/BS-19), presently at the disposal of Establishment Division, is transferred and placed at the disposal of Ministry of Railways for further posting as Director (HR/E) on deputation basis for a period of three years on standard terms and conditions, with immediate effect and until further orders.

SHEIKH MUHAMMAD UMAR FAROOQ,  
Section Officer.

Islamabad, the 4th June, 2020

**No. F.24/4/2013-E-1.**—Mr. Muhammad Saleem Ranjha, a BS-21 Officer of Pakistan Customs Service, presently posted as Additional Secretary, Federal Education & Professional Training Division is repatriated to his parent department *i.e.* Federal Board of Revenue (FBR) with immediate effect.

**No. F.22/01/2019-E-I.**—The competent authority has been pleased to appoint Mr. Haseeb Muhammad S/o. Riaz Majeed, as Pilot (Special Scale) in the Department of Plant Protection, under Ministry of National Food Security & Research, subject to certification of medical fitness and validity of pilot license, on contract basis, with immediate effect, for a period for a period of two years or till arrival of regular incumbent, whichever is earlier.

**No. F.22/01/2019-E-I.**—The competent authority has been pleased to appoint Mr. Muhammad S/o. Abid Siddiqui, as Pilot (Special Scale) in the Department of Plant Protection, under Ministry of National Food Security & Research, subject to certification of medical fitness and validity of pilot license, on contract basis, with immediate effect, for a period for a period of two years or till arrival of regular incumbent, whichever is earlier.

**No. F.22/01/2019-E-I.**—The competent authority has been pleased to appoint Mr. Abdul Saboor Raza S/o. Hamid Raza Lodhra, as Pilot (Special Scale) in the Department of Plant Protection, under Ministry of National Food Security & Research, subject to certification of medical fitness and validity of pilot license, on contract basis, with immediate

effect, for a period for a period of two years or till arrival of regular incumbent, whichever is earlier.

ATIF R. KHATTAK,  
Section Officer.

Islamabad, the 5th June, 2020

**No. 1/3/2020-D-I.**—Consequent upon his release on bail by Lahore High Court, Lahore *vide* order dated 25th February, 2020 Mr. Waseem Ajmal Chaudhry (PAS/BS-20) placed under suspension under CSR 194, *vide* notification of even number dated 20th May, 2020 is re-instated into service with effect from 25th February, 2020, without prejudice to the final outcome of Court Decision.

KAUSAR ALI KHAN,  
Section Officer.

(Poverty Alleviation & Social Safety Division)

Islamabad, the 12th June, 2020

**No. PASS&D.SO.P.1-2/2020-(A-IV)-244.**—In pursuance of Establishment Division's Notification No.1-68/2012-E-2, dated 24th April, 2019 and O.M. dated 8th June, 2020, Mr. Farid Islam Khattak, Deputy Secretary (BS-19) has assumed the charge of the post of Deputy Secretary (BS-19) in the Poverty Alleviation & Social Safety Division (PA&SSD) on 12th June, 2020.

This issues with the approval of Secretary, PA&SS Division.

GUL ZAMAN,  
Section Officer (A-IV).

[BENAZIR INCOME SUPPORT PROGRAMME]

Islamabad, the 4th June, 2020

**No. 1(875)/BISP/HR/KPK/2016.**—In pursuance of Establishment Division's Notification No.PF.1/20/2013-E-2, dated 28th May, 2020, deputation period of Mr. Rasheed Noor, a BS-19 Officer of Secretariat Group, presently posted as Director (HQ), BISP Regional Office, KP is hereby extended for a period of one year (5th year) with effect from 31st May, 2020 to 30th May, 2021 on standard terms and conditions.

This issues with the approval of the Secretary, BISP Islamabad.

**No. F.1(1119)/BISP/HR/S/2016.**—In pursuance of National Vocational and Technical Training Commission, Islamabad's O.M. No.2(141)2013-Admn, dated 20th May, 2020 and Ministry of Federal Education & Professional

Training, Islamabad O.M. No.8-7/2020-GPIW, dated 18th March, 2020, Mr. Waheed Ali Naich, Assistant Accounts Officer (BS-17), Government Polytechnic Institute for Women, H-8/1, Islamabad, presently posted as Assistant Director (SPS-17) in BISP Sindh Region, is hereby repatriated to his parent department with immediate effect.

This issues with the approval of the Secretary BISP.

ZAHEER HUSSAIN,  
Deputy Director (HR-II).

---

WAFAQI MOHTASIB (OMBUDSMAN)'S SECRETARIAT

Islamabad, the 5th June, 2020

**No. F.1(437)A-II/2013.**—In exercise of the powers conferred upon him *vide* Rule 20 (3) of the Wafaqi Mohtasib (Ombudsman)'s Secretariat Officers Service Rules, 2009, the Secretary, Wafaqi Mohtasib Secretariat, being the Appointing Authority, has been pleased to terminate the probationary period in respect of Mr. Shahid Mahmood, Assistant Director (BS-17) WMS, Head Office, Islamabad with effect from 6th January, 2020.

**No. F.1(438)A-II/2013.**—In exercise of the powers conferred upon him *vide* Rule 20 (3) of the Wafaqi Mohtasib (Ombudsman)'s Secretariat Officers Service Rules, 2009, the Secretary, Wafaqi Mohtasib Secretariat, being the Appointing Authority, has been pleased to terminate the probationary period in respect of Ms. Muhammad Nasarullah, Assistant Director (BS-17) WMS, Head Office, Islamabad with effect from 6th January, 2020.

**No. F.1(433)A-II/2013.**—In exercise of the powers conferred upon him *vide* Rule 20 (3) of the Wafaqi Mohtasib (Ombudsman)'s Secretariat Officers Service Rules, 2009, the Secretary, Wafaqi Mohtasib Secretariat, being the Appointing Authority, has been pleased to terminate the probationary period in respect of Ms. Shamshad Roohi, Assistant Director (BS-17) WMS, Head Office, Islamabad with effect from 6th January, 2020.

**No. F.1(432)A-II/2013.**—In exercise of the powers conferred upon him *vide* Rule 20 (3) of the Wafaqi Mohtasib (Ombudsman)'s Secretariat Officers Service Rules, 2009, the Secretary, Wafaqi Mohtasib Secretariat, being the Appointing Authority, has been pleased to terminate the probationary period in respect of Ms. Nilofar Rashid, Assistant Director (BS-17) WMS, Head Office, Islamabad with effect from 6th January, 2020.

**No. 7(204)A-I/2020.**—In pursuance of Notification No.8(201)A-I/1996, dated 30th April, 2020, Mr. Muhammad Bakhsh, has assumed the charge of the post of Assistant Private Secretary (BS-16) at Wafaqi Mohtasib Secretariat, Regional Office, Multan, with effect from 18th May, 2020.

MOINUDDIN A. SIDDIQI,  
Director (Admn).

MINISTRY OF CLIMATE CHANGE

Islamabad, the 8th June, 2020

**No. F.1(151)/Admn-I/CC/2020.**—In pursuance of Establishment Division's Notification No.39/1024/2014-E-I, dated 21st May, 2020, Syed Mujtaba Hussain, a BS-20 Officer of Secretariat Group, has assumed the charge of the post of Joint Secretary (IC/BS-20) in the Ministry of Climate Change on 2nd June, 2020.

This issues with approval of the Secretary, MOCC.

SAMI UL HAQ,  
Section Officer (Admn-I).

---

MINISTRY OF COMMERCE

Islamabad, the 8th June, 2020

**No. 10(4)/1980-Admn-I/MoC.**—Mr. Muhammad Hussain, Private Secretary (BS-17/Retd), Ministry of Commerce, Islamabad, is granted 365 days leave encashment in lieu of LPR, with effect from 6th June, 2019 to 5th June, 2020.

On expiry of leave encashment in lieu of LPR, the officer stands retired from Government Service on attaining the age of superannuation, *i.e.* 5th June, 2020 (A.N).

**No. 10(4)/1980-Admn-I/MoC.**—In pursuance of Ministry of Commerce's notification of even number dated 8th June, 2020, Mr. Muhammad Hussain, has relinquished the charge of the post of Private Secretary (BS-17), Ministry of Commerce, Islamabad with effect from 5th June, 2020 (A.N). The officer stands retired from Government Service on attaining the age of superannuation, *i.e.* 5th June, 2020 (A.N).

MUHAMMAD IMTIAZ,  
Deputy Director (MoC).

---

MINISTRY OF COMMUNICATION

Islamabad, the 3rd June, 2020

**No. PF-209/2017-Admn.**—In pursuance of Establishment Division's Notification No.PF(569)E-5(PAS) dated 29th May, 2020 Dr. Tashfeen Khan a BS-21 Officer of Pakistan Administrative Services, has relinquished the charge of the post of Additional Secretary, Ministry of Communication, Government of Pakistan, Islamabad, on 1st June, 2020.

**No. PF-231/2020-Admn.**—In pursuance of Establishment Division's Notification No.PF(763)E-5(PAS) dated 29th May, 2020 Mr. Tariq Viqar Bakhshi an Officer of (BS-20) Officer of Pakistan Administrative Services, has assumed the charge of the post of Additional Secretary,

Ministry of Communication, Government of Pakistan, Islamabad, under Section 10 of Civil Servants Act, 1973, on 1st June, 2020.

MUHAMMAD HASAN SHAFQAAT,  
Deputy Secretary.

DEPARTMENT OF THE AUDITOR GENERAL  
OF PAKISTAN

Islamabad, the 5th June, 2020

**No. 502-Dir(A)/9-2/15.**—The following officers of Office of Auditor General of Pakistan are assigned the look after charge of the post of Chief Finance & Accounts Officer (CF&AO) to the officers as mentioned against each, with immediate effect and until further orders:-

S. No.	Name of Officers (M/s)	Present Posting	Assigned Look-After Charge of the Post of
1	Mr. Muhammad Azhar (BS-20/PA&AS)	Chief Finance & Accounts Officer, Ministry of Maritime Affairs, Islamabad,	Chief Finance & Accounts Officer, Railway Division, Islamabad, with immediate effect, in addition to his own duties, till further orders.
2	Mr. Zia-ul-Islam Khan Niazi (BS-20/PA&AS)	Chief Finance & Accounts Officer, Planning & Development Division	Chief Finance & Accounts Officer, Information & Broadcasting Division, Islamabad, with immediate effect, in additional to his own duties, till further orders.

**No. 501-Dir(A)/9-2/15.**—Mrs. Shazana Durrani, a BS-19 Officer of Pakistan Audit and Accounts Service presently posted in Office of Auditor General of Pakistan (AGP), is transferred and posted as Chief Finance & Accounts Officer (CF&AO) (OPS), Establishment Division, with immediate effect and until further orders.

2. The officer is also assigned look after charge of the post of CF&AO, Cabinet Division, Islamabad with immediate effect for the period during which the present incumbent Mr. Muhammad Saeed Kalwar remains on leave or until further orders.

**No. 503-Dir(A)/9-2/15.**—The following officers of Office of Auditor General of Pakistan are transferred &

posted as Chief Finance & Accounts Officer (CF&AO), with immediate effect and until further orders:-

S. No.	Name of Officers (M/s)	From	To
1	Kh. Owais Adil (BS-20/PA&AS)	Accountant General, Balochistan, Quetta (OPS)	Chief Finance & Accounts Officer, Economic Affairs Division, Islamabad.
2	Mr. Muhammad Saeed BS-20/PA&AS	Awaiting posting at HQ, Lahore	Chief Finance & Accounts Officer, National Food Security & Research Division.

ZULFIQAR KHAN,  
Director (Administration).

Islamabad, the 4th June, 2020

**No. 326/Estt-C/29-2008-I.**—In continuation of this office earlier Notification No.303/Estt-C/29-2008-I dated 20th May, 2020, the competent authority has been pleased to direct that the HoDs of all Field Audit Offices (FAOs) may scrutinize and submit the cases of the officers/ officials of departmental cadre which fall in the ambit of "Directory Retirement" to this office by return fax.

This issues with the approval of the competent authority.

AMJAD ALI GILL,  
Director (Establishment).

Islamabad, the 4th June, 2020

**No. 322/Estt-C/01-2016.**—Mr. Rizawan ul Haq, Assistant Audit Officer (BS-17), office of the Director General Audit Railways, Lahore has expired on 12th April, 2020 (May his soul rest in peace)

His name is therefore accordingly struck off the strength from this department with effect from 12th April, 2019.

SYED WASEEM ABBAS,  
Audit Officer (Establishment).

[OFFICE OF THE CONTROLLER GENERAL OF ACCOUNTS]

Islamabad, the 3rd June, 2020

**No. 333/CGA/Admn-I/01-105/2013.**—In pursuance of this Office Notification No.386/CGA/PAAS/1-14/2020 dated 8th May, 2020 Mr. Farrukh Suhail Malik, has relinquished

the charge of the post of Deputy Controller General of Accounts (FABs) (OPS) in this office on 11th May, 2020 to join his new assignment as Accountant General Balochistan, Quetta (OPS).

Islamabad, the 4th June, 2020

**No. 337/CGA/Admn-I/07-15/2006.**—Consequent upon his posting on deputation in Federal Government Employees Housing Authority, Islamabad *vide* this Office Letter No.320/CGA/Estt-II/AAO/CGA/PT/28-C dated 5th May, 2020, Mr. Shah Faisal, Assistant Private Secretary (B-16) of this office has relinquished the charge of his post on 15th May, 2020.

JIBRAN KHAN DURRANI,  
Assistant Controller General of Accounts (Admin).

Islamabad, the 3rd June, 2020

**No. 325/14-16/CGA/Discipline/2018.**—Mr. Muhammad Ali Accounts Officer, office of the Director General, Accounts works Lahore, was charge with "Misconduct" under Government Servants (E&D) Rules-1973. The inquiry was conducted for purpose and the officer was served with Show Cause Notice. On receipt of his reply there to and as result of personal hearing afforded to him, the case has been considered by Dy. CGA being the Authorized Officer, in the light of facts/findings of the Inquiry Report and has decided to impose minor penalty of "Censure" in the light of Rule-4 (a) (i) of Government Servants (E&D) Rules 1973.

ROIDAR ALI,  
Accounts Officer (Discipline).

---

ELECTION COMMISSION OF PAKISTAN

Islamabad, the 5th June, 2020

**No. F.4(48)/2015-Estt-I.**—Ms. Nafeesa Hashmi, Deputy Director (Protocol) in the Election Commission Secretariat, Islamabad is granted 90 days maternity leave from 2nd June to 30th August, 2020.

2. On the expiry of the leave, Ms. Nafeesa Hashmi is likely to assume charge of the same post at Islamabad.

3. Mr. Ghulam Abbas, Deputy Director (LGE-Balochistan) in the Election Commission Secretariat, Islamabad is assigned the additional charge of the post of Deputy Director (Protocol) from 2nd June to 30th August, 2020 during the leave period of Ms. Nafeesa Hashmi.

4. This issues with the approval of the Secretary, Election Commission of Pakistan.

Islamabad, the 8th June, 2020

**No. F.3(2)/2020-Estt-I.**—In pursuance of this Commission's notification of even number dated 3rd June, 2020, Mr. Imran Zafar, has relinquished the charge of the

post of Deputy Director (Confidential-BS-18) in the forenoon of 4th June, 2020 and assumed the charge of the post of Staff Officer (BS-18) to the Secretary in forenoon of same date.

WASEEM AHMED,  
Deputy Director (Estt-I).

[OFFICE OF THE PROVINCIAL ELECTION COMMISSIONER PUNJAB]

Lahore, the 2nd June, 2020

**No. F.11(4)/2004-Estt-Vol-I.**—Mr. Irfan Kausar, District Election Commissioner-I, Gujranwala is granted 09 days leave on full pay with effect from 14th May, 2020 to 22nd May, 2020.

On the expiry of leave he was likely to resume his duty on the same post and at the same station.

ABDUL HAMEED,  
Director (Estt).

---

MINISTRY OF FINANCE, REVENUE AND  
ECONOMIC AFFAIRS

(Finance Division)

[MILITARY FINANCE WING]

Rawalpindi, the 3rd June, 2020

**No. F.5-1/HRM-I/1133.**—In terms of Establishment Division's O.M. dated 18th June, 1980, Mr. Muhammad Iqbal, Superintendent of MF (HIB) Taxila office of this Wing has been allowed to hold current charge against the vacant post of Assistant Financial Adviser (HIB) for a period of three months with effect from 1st June, 2020, or till the posting of regular incumbent whichever is earlier.

Rawalpindi, the 4th June, 2020

**No. F.15-596/HRM-I/1143.**—In continuation of Gazette Notification No.F.15-596/HRM-I/919, dated 23rd April, 2020, Mr. Laeeq-ur-Rehman, Assistant Financial Adviser of this Wing has further been granted 21 days LFP on medical grounds with effect from 1st May, 2020 to 21st May, 2020.

After expiry of leave, the officer has resumed his duties on the same post at the same station.

MUHAMMAD ALI DURRANI,  
Assistant Financial Adviser (HRM-I).

(Revenue Division)

Islamabad, the 1st June, 2020

**No. 6(11)/2011-Admn.**—Ms. Madeeha Khattak, Section Officer (Admn) of this Division is hereby assigned additional charge of the post of Section Officer (Gen), in



addition to her own duties with effect from 8th April, 2020 initially for a period of three months, or till the posting of regular Section Officer by Establishment Division whichever is earlier. She will be entitled for an additional remuneration @ 20% of her basic pay not exceeding Rs.12,000/- pm in terms of existing instructions of the Finance Division.

This issues with the approval of Additional Secretary, Revenue Division.

RUSTAM KHAN,  
Deputy Secretary (Admn).

Islamabad, the 1st June, 2020

**No. 3(1)/2011-Admn.**—The competent authority has been pleased to assign the duty of Deputy Secretary (Admn) to Mr. Rustam Khan, Section Officer (B&A/DDO), Revenue Division, on look after basis with effect from 20th May, 2020 until the posting of regular incumbent which is earlier. The said officer shall not exercise "Financial powers" delegated to the post of Deputy Secretary (Admn) and will only look after his work on day to day basis.

This issues with the approval of Additional Secretary, Revenue Division.

MADEEHA KHATTAK,  
Section Officer (Admn).

(Economic Affairs Division)

Islamabad, the 2nd June, 2020

**No. 7(2)/EA/A1/2020.**—Mr. Muhammad Ishaque, Accounts Officer/ Section Officer (F&A), is assigned with immediate effect, additional charge of the post of Accounts Officer, PIDSA Project, PC Wing, Economic Affairs Division for a period of three months (90 days) or till the availability of regular incumbent of the post whichever is earlier. As per rules, he will be entitled to draw "Special Allowance" equal to @ 20% of basic pay subject to a maximum of Rs.12,000/- p.m whichever is less.

This issues with the approval of Secretary, Economic Affairs Division.

**No. 1(21)/EA/A1/2018.**—Ms. Aaleen Mehboob, Section Officer (UN-III), is assigned with effect from 18th May, 2020, additional charge the post of Section Officer (UN-II), UN Wing, Economic Affairs Division for a period of three months (90 days). As per rules, she will be entitled to draw "Special Allowance" equal to @ 20% of basic pay subject to a maximum of Rs.12,000/- p.m whichever is less.

This issues with the approval of Secretary, Economic Affairs Division.

**No. 7(2)/EA/A/2020.**—Mr. Amjid Hussain, Section Officer (Eur-I), is assigned with immediate effect, additional charge of the post of Section Officer PIDSA Project, PC Wing, Economic Affairs Division for a period of three months (90 days). As per rules, he will be entitled to draw "Special Allowance" equal to @ 20% of basic pay subject to a maximum of Rs.12,000/- p.m whichever is less.

This issues with the approval of Secretary, Economic Affairs Division.

Islamabad, the 8th June, 2020

**No. 1(9)/EA/A-I/2018.**—Dr. Muhammad Arshad, Deputy Chief (BS-19) (Policy), is assigned with effect from 1st May, 2020, Current Charge of the post of Chief, (BS-20) PA&D Wing, Economic Affairs Division for a period of three months (90 days) or till the availability of a regular incumbent of the post whichever is earlier. As per rules, he will be entitled to draw "Special Pay" equal to 20% of basic pay subject to a maximum of Rs.12,000/- p.m whichever is less.

This issues with the approval of Secretary, Economic Affairs Division.

SAJID HUSSAIN ABBASI,  
Section Officer (Admin-I).

Islamabad, the 4th June, 2020

**No. F.1(1)/EA/A1/2020.**—Mr. Fahad Mahmud Mirza, Section Officer (BS-18-Acting Charge) (Personnel No.50281296), Economic Affairs Division is granted Seventeen (17) days leave on full pay with effect from 1st June to 17th June, 2020, under the Revised Leave Rules, 1980.

On the expiry of leave, the officer is expected to resume charge of the same post in this Division, at Islamabad.

KHALID MAHMOOD,  
Section Officer (Admin-I).

---

MINISTRY OF HOUSING & WORKS

Islamabad, the 3rd June, 2020

**No. F.12(33)/97-EO.**—With the approval of Secretary (H&W), Mr. Hafeez ur Rehman, Superintendent (General/BS-17), Estate Office, Peshawar is allowed to hold current charge of the post of Joint Estate Officer (BS-17) in Estate Office, Peshawar in addition to his own duties initially with immediate effect for a period of three months or till the posting of regular incumbent.

Moreover, the officer is also allowed to exercise the powers of Drawing & Disbursement Officer of Estate Office, Peshawar to avoid any financial complication.

Islamabad, the 5th June, 2020

**No. F.568/2020-Admn-I.**—In pursuance of the recommendations of the Departmental Promotion Committee held on 28th April, 2020, and with the approval of Chairman, National Construction Limited *i.e.* Secretary (H&W), the following officers of National Construction Limited are promoted to next higher grade mentioned against each:-

Sl. No.	Name, Designation and Present Grade	Promoted as	Remarks
1.	Mrs. Zonaira Tariq, Deputy General Manager (South) (Grade-II)	General Manager (South) (Grade-I)	—
2.	Mr. Ahmed Nabi, Manager Q.S, (Grade-III)	Manager (Contracts) (Grade-II)	—
3.	Mr. Mazhar ul Haq, Assistant Manager (Accounts), (Grade-IV)	Deputy Manager (Accounts) (Grade-III)	—
4.	Mr. Asif Saeed Dar, Manager (EDP)/Taxation (Grade-III)	Manager (EDP/Taxation) (Grade-II)	—
5.	Mr. Rehan Ali Cheema, Manager (Admin & Protocol)/PR (Grade-III)	Promoted to Grade-II (BS-18)	The Committee allowed the officer to actualize his promotion at his present place of posting (FGEHA).
6.	Mr. Arshad Hussain Khan, Manager (HR & Legal) (Grade-III)	Manager (HR & Legal) (Grade-II)	—

Sl. No.	Name, designation and present Grade	Promoted as	Remarks
7.	Mr. Azmat Abbas, Assistant Manager (Admin & Protocol)/ PPR, (Grade-IV)	Deputy Manager (Admin & Protocol/PR) (Grade-III)	—
8.	Mr. Tahir Hussain, PSO to MD/Manger (Coord) (Grade-III)	PSO to MD/ Manger (Coord) (Grade-II)	—

AAMIR ALTAF ALVI,  
Section Officer.

Islamabad, the 8th June, 2020

**No. F.1(15)/2019-Admn-I.**—In pursuance of Establishment Division, Islamabad's Notification No.1071/2011-E-VII dated 12th May, 2020, Mr. Azmat Ali, has assumed the charge of the post of Section Officer (OMG/BS-18) in the Ministry of Housing & Works on 21st May, 2020.

MUBEEN AHMED KAINTHE,  
Section Officer (Admn-I).

MINISTRY OF HUMAN RIGHTS

Islamabad, the 1st June, 2020

**No. F.2-5/2007-HR.**—Mr. Muzaffar Ali, Assistant Private Secretary (BS-16) of this Ministry has been granted 45 days LFP with effect from 15th May, 2020 to 28th June, 2020 with permission to leave the station.

This issues with the approval of the Joint Secretary (Admin), Ministry of Human Rights, Islamabad.

Islamabad, the 3rd June, 2020

**No. F.1-20/2020-Admn.**—In pursuance of this Ministry's offer of appointment Letter No.4(5)/2019-Admn, dated 16th March, 2020 and on the acceptance of terms and conditions, Ms. Mehreen Gul D/o. Dost Muhammad Khan is appointed as Assistant Director (Communication Expert & Web Manager/ Developer) (BS-17) in the project titled "Human Rights Awareness Programme" on two years contract basis with effect from 19th May, 2020.

This issues with the approval of the Secretary, Ministry of Human Rights, Islamabad.

**No. F.1-3/2020-Admn.**—In pursuance of this Ministry's offer of appointment Letter No.4(4)/2019-Admn, dated 16th March, 2020 and on the acceptance of terms and

conditions, Mr. Ateeq Sarwar S/o. Muhammad Sarwar is appointed as Assistant Director (Information Communication Technology) (Network/System Administrator) (BS-17) in the project titled "Institutional Strengthening of Ministry of Human Rights" on two years contract basis with effect from 19th May, 2020.

This issues with the approval of the Secretary, Ministry of Human Rights, Islamabad.

**No. F.1-5/2020-Admn.**—In pursuance of this Ministry's offer of appointment Letter No.4(4)/2019-Admn, dated 16th March, 2020 and on the acceptance of terms and conditions, Ms. Maham Liaqat D/o. Liaqat Ali is appointed as Assistant Director (Research and Development) (BS-17) in the project titled "Institutional Strengthening of Ministry of Human Rights" on two years contract basis with effect from 19th May, 2020.

Her appointment is subject to provision of final medical fitness certificate within 03 months, failing which the appointment would stand cancelled.

This issues with the approval of the Secretary, Ministry of Human Rights, Islamabad.

MUHAMMAD ASIF,  
Section Officer (Admn).

---

MINISTRY OF INDUSTRIES & PRODUCTION

Islamabad, the 4th June, 2020

**No. 1(22)/2018-Admn-I.**—Mr. Niaz Muhammad Khan, Senior Joint Secretary, Ministry of Industries & Production is granted 20 days quarantine leave on full pay with effect from 28th May, 2020.

After expiry of leave the officer is expected to resume his duty at the same place and post.

This has the approval of the Secretary, I&P.

**No. 1(60)/2019-Admn-I.**—Mr. Rafey Ahmed, Section Officer, Ministry of Industries & Production is granted quarantine leave on full pay with effect from 27th May, 2020 to 12th June, 2020.

After expiry of leave the officer is expected to resume his duty at the same place and post.

This has the approval of the Secretary, I&P.

OMER MANZOOR SHEIKH,  
Section Officer (Admn-I).

Islamabad, the 4th June, 2020

**No. 1(8)/2020-PSD-II(1).**—In pursuance of Cabinet Division's Memorandum No.4-11/2019-Min-I dated 14th April, 2020, the competent authority has been pleased to

notify Pakistan Institute of Management (PIM), Karachi as an Autonomous Body under Industries & Production Division, Islamabad.

PIM will be shown as an Autonomous Body in Schedule-II to the Rules of Business, 1973 under Industries & Production Division, Islamabad.

This issues with the approval of Secretary, Industries & Production.

**No. 1(8)/2020-PSD-II(II).**—In pursuance of Cabinet Division's Memorandum No.4-11/2019-Min-I dated 14th April, 2020, the competent authority has been pleased to notify Pakistan Industrial Technical Assistance Centre (PITAC), Lahore as an Autonomous Body under Industries & Production Division, Islamabad with immediate effect.

PITAC will be shown as an Autonomous Body in Schedule-II to the Rules of Business, 1973 under Industries & Production Division, Islamabad.

This issues with the approval of Secretary, Industries & Production.

AKHLAQ MAHMOOD,  
Section Officer (PSD-II).

---

MINISTRY OF INFORMATION TECHNOLOGY AND  
TELECOMMUNICATION

Islamabad, the 5th June, 2020

**No. F.4-1/2018-Dev.**—In pursuance of Establishment Division's Notification No.1/13/2018-E.6 dated 14th May, 2020, the contract appointment to Mr. Faisal Ratyal, Director General (PMO), National Information Technology Board (NITB) under Ministry of Information Technology and Telecommunication in MP-II Scale is extended on existing terms and conditions for a period of one (01) year with effect from 28th May, 2020.

NASEEM AHMAD KHAN,  
Deputy Secretary.

---

MINISTRY OF INTERIOR

Islamabad, the 2nd June, 2020

**No. 5/5/2020-Admn-I.**—In pursuance of the Establishment Division's Notification No.1-32/2010-E-2, dated 27th February, 2020, Mr. Khair Muhammad Kalwar (BS-19/SG) has assumed the charge of the post of Deputy Secretary (BS-19/SG), Interior Division on 24th March, 2020.

**No. 5/32/2017-Admn-I.**—In pursuance of Establishment Division's Notification No.1-29/2011-E-2, dated 14th February, 2020, Mr. Muzafar Ali Burki, a BS-19 Officer of Secretariat Group has relinquished the charge of the post of Deputy Secretary, Interior Division on 14th February, 2020.

Islamabad, the 3rd June, 2020

**No. 4/5/2019-Admn-I.**—Mr. Shadab Ahmed, Superintendent (BS-16), Ministry of Interior is hereby granted current charge of the post of Section Officer (G&P) with effect from 22nd March, 2020 for a period of three months or till posting of a regular incumbent.

This issues with the approval of the Additional Secretary-I.

Islamabad, the 4th June, 2020

**No. 5/10/2020-Admn-I.**—In pursuance of the Establishment Division's Notification No.PF.945/2009-E-VII dated 12th May, 2020, Ms. Nausheen Mohy-ud-Din, Section Officer (OMG/BS-18) has assumed the charge of the post of Section Officer, Interior Division on 1st June, 2020.

Islamabad, the 5th June, 2020

**No. 5/9/2020-Admn-I.**—In pursuance of the Establishment Division's Notification No.F.4/84/2013-E-VII dated 19th May, 2020, Mr. Rashid Ahmad, Section Officer (BS-17/Deputationist) has assumed the charge of the post of Section Officer, Interior Division on 2nd June, 2020.

Islamabad, the 8th June, 2020

**No. 5/6/2018-Admn-I.**—Consequent upon the approval of the competent authority, Mr. Abdul Aziz Uqaili (PAS/BS-21), Additional Secretary-I, Ministry of Interior has been granted ninety three (93) days *ex-Pakistan* leave (on full pay) with effect from 28th May, 2020 on account of private affairs.

On expiry of the leave, the officer is expected to report to Ministry of Interior on due date.

MUHAMMAD UMAIR,  
Section Officer (Admn-I).

Islamabad, the 3rd June, 2020

**No. F.4/5/2019-CPEC(JWG).**—In partial modification of this Ministry's Notification No.13/41/2016-(CPEC)-JWG dated 25th April, 2018, revised composition of the Pak-China Joint Working Group (JWG) on safety and Security of CPEC is as under:-

1.	Additional Secretary-II, Ministry of Interior, Islamabad	Head
2.	Joint Secretary (CAF), Ministry of Interior	Member
3.	Director General (China), Ministry of Foreign Affairs	-do-

4.	Chief Executive Officer (CEO), CPEC Authority Ministry of Planning, Development & Special Initiatives	Member
5.	Joint Secretary, Ministry of Finance	-do-
6.	Joint Secretary, Ministry of Water & Power	-do-
7.	Joint Secretary, Ministry of Communications	-do-
8.	Director General, National Police Bureau, Islamabad	-do-
9.	Additional Director General, FIA HQs, Islamabad	-do-
10.	Brigadier, Inter Services Intelligence (ISI)	-do-
11.	Director, Intelligence Bureau (IB)	-do-
12.	Brigadier, Special Security Division (SSD)	-do-
13.	Lieutenant Colonel, MO. Dte. GHQ, Rawalpindi	-do-
14.	Joint Secretary-II, Ministry of Defence	-do-
15.	Deputy Director General Pakistan Coast Guards, Karachi	-do-
16.	Assistant Chief of Naval Staff, Pakistan Navy	-do-
17.	Assistant Chief of Air Staff (Plans), Pakistan Air Force	-do-
18.	Deputy Director General, Pakistan Maritime Security Agency	-do-
19.	Director General, (NC Sectt.) NACTA	-do-
20.	Coordinator Security-CPEC, PMDU, PM Office (Public), Islamabad	-do-

MUHAMMAD ABRAR AZAM,  
Section Officer (CPEC).

Islamabad, the 3rd June, 2020

**No. 3/73/2019-FIA/Estt.**—In pursuance of the Establishment Division's Notification No.12(14)/92-E-3(Police), dated 7th May, 2020, Mr. Tariq Nawaz Malik (PSP/BS-21) has relinquished the charge of the post of Addl. Director General (FIA), on 1st June, 2020.

M. AWAIS JAVED,  
Section Officer (FIA/Estt).

MINISTRY OF LAW AND JUSTICE

(Law and Justice Division)

Islamabad, the 5th June, 2020

**No. F.4(3)/2015-A.V.**—Consequent upon approval of the competent authority, Mr. Nasir Masroor Ahmed, Chairman, Anti-Dumping Tribunal, Islamabad is hereby entrusted the additional charge of the post of Member Technical-I (BS-22), Competition Appellate Tribunal, Islamabad with immediate effect, for a period of three months or till arrival of a regular incumbent or till further orders, whichever is earlier.

Islamabad, the 8th June, 2020

**No. F.8(27)/2017-A.V.**—In continuation of this Division's notification of even number dated 19th May, 2020, Ms. Ambareen Naveed, Judge, Banking Court-I, Peshawar is also authorized to exercise the powers of Drawing and Disbursing Officer (DDO) of Special Court (Central), Peshawar with immediate effect and until further orders.

**No. F.7(37)/2019-A.V.**—With the approval of the competent authority Mr. Nazakat Ali Bhand, Registrar, Accountability Court-II, Karachi is entrusted the additional charge of the vacant post of Registrar, Accountability Court-I, Karachi alongwith 20% additional charge allowance as admissible under the rules for a period of three months from the date of charge assumption with immediate effect and until further orders.

MUHAMMAD KAMRAN,  
Section Officer (A-V).

Islamabad, the 9th June, 2020

**No. F.1(24)/2015-A.IV.**—The Secretary, Law and Justice Division has been pleased to withdraw his approval granted to Mir Badshah Khan Wazir, Accountant Member (BS-21), Appellate Tribunal Inland Revenue, Peshawar to avail ex-Pakistan leave with effect from 1st June, 2020 to 12th June, 2020 along with NOC to proceed abroad to participate in Foreign Study Tour of National Security and War Course (NS&WC), 2019-2020.

FAISAL MALIK,  
Section Officer.

MINISTRY OF MARITIME AFFAIRS

Islamabad, the 5th June, 2020

**No. 1(4)/2018-Fish.**—The competent authority has been pleased to entrust the current charge of the post of Director General, Marine Fisheries Department, Karachi to Mr. Asif Haroon, Director (Shipping), Ports & Shipping Wing, Karachi in addition to his own duties for a period of one month with immediate effect.

DR. MUHAMMAD ASIF RIAZ,  
Section Officer (Fish).

Islamabad, the 9th June, 2020

**No. F.1(1)/2019-PNSC.**—In pursuance of Government of Pakistan, Cabinet Secretariat, Establishment Division's Notification No.PF(751)/E-5(PAS) dated 9th June, 2020, Mr. Rizwan Ahmed (PAS/BS-22), has relinquished the charge as member on the Board of Directors and Chairman, Pakistan National Shipping Corporation (PNSC) with effect from 9th June, 2020.

**No. F.1(1)/2019-PNSC.**—In pursuance of Government of Pakistan, Cabinet Secretariat, Establishment Division's Notification No.PF(751)/E-5(PAS) dated 9th June, 2020, Mr. Shakeel Ahmed Mangnejo (PAS/BS-21), has assumed the charge as a member on the Board of Directors and Chairman, Pakistan National Shipping Corporation (PNSC) with effect from 9th June, 2020.

IJAZ AHMAD,  
Section Officer (PNSC).

[PORTS & SHIPPING WING]

Karachi, the 9th June, 2020

**No. 13(1)/2019-Estt.**—In pursuance of Government of Pakistan, Cabinet Secretariat, Establishment Division's Notification No.PF(751)/E-5(PAS) dated 9th June, 2020, Mr. Shakeel Ahmed Mangnejo, an officer of Pakistan Administrative Service (BPS-21), has relinquished the charge of the post of Director General (BS-21), Ports & Shipping Wing, Karachi with effect from 9th June, 2020.

ALI MUHAMMAD,  
Section Officer (Estt).

MINISTRY OF NATIONAL HEALTH SERVICES,  
REGULATIONS & COORDINATION

Islamabad, the 5th June, 2020

**No. F.11-96/2020-(Admn-I).**—In continuation of this Ministry's order dated 2nd March, 2020, Syed Ata ur Rehman, Additional Secretary, M/o. NHS,R&C shall act as

Executive Director, PHRC, as per Rule 2 (5) of Pakistan Health Research Council (Appointment of Executive Director) Rules, 2019, with immediate effect and until further orders.

Islamabad, the 8th June, 2020

**No. PF.11(57)/SHM/2019-Admn-I.**—Syed Hassan Mahmood, Section Officer (Training/ Foreign Assistance), Ministry of National Health Services, Regulations and Coordination is assigned additional charge of the post of Section Officer (Coord) with immediate effect for a period of three months or till posting of a regular incumbent, whichever is earlier.

This issues with the approval of the Additional Secretary, M/o. NHS,R&C.

ASGHAR ALI,  
Deputy Secretary (Admn).

Islamabad, the 8th June, 2020

**No. PF.11(57)/SHM/2019-Admn-I.**—Mr. Aamer Waheed, Superintendent (Pension Cell), Ministry of National Health Services, Regulations and Coordination is assigned additional charge of the post of Superintendent (Record) with immediate effect for a period of three months or till posting of a regular incumbent, whichever is earlier.

This issues with the approval of the Additional Secretary, M/o. NHS,R&C.

**No. PF.11(57)/SHM/2019-Admn-I.**—Mr. Zuhaib Hassan Shaikh, Section Officer (Estab-I), Ministry of National Health Services, Regulations and Coordination is assigned additional charge of the post of Section Officer (Admn-II), with immediate effect for a period of three months or till posting of a regular incumbent, whichever is earlier.

This issues with the approval of the Additional Secretary, M/o. NHS,R&C.

FARHAN SIKANDAR,  
Section Officer (Admn-I).

[DRUG REGULATORY AUTHORITY OF PAKISTAN]

Islamabad, the 4th June, 2020

**No. F.27-2/2001-(Vol-II).**—Mr. Abdus Samad, Assistant Chemist (RO-11), Central Drugs Laboratory, Drug Regulatory Authority of Pakistan, Karachi has been granted 11 days leave with full pay with effect from 11th May, 2020 to 21st May, 2020 with permission to leave the station.

After availing the said leave, the officer concerned has assumed the charge of the same post at the same station with effect from 28th May, 2020 being Public holidays with effect from 22nd May, 2020 to 27th May, 2020.

This issues with the approval of competent authority.

Islamabad, the 5th June, 2020

**No. PF.435-WUR/Admn-I.**—Mr. Wajid-ur-Rehman, Assistant Private Secretary, (RO-11), Drug Licensing Division, Drug Regulatory Authority of Pakistan, Islamabad has been granted 12 days leave with full pay with effect from 1st June, 2020 to 12th June, 2020 with permission to leave the station.

2. After expiry of said leave, the officer concerned is expected to resume his duty on the same post and at the same station.

3. During the leave period, Mr. Mudabbir Iqbal, LDC, Drug Licensing Division, DRAP is assigned to look after the official work of Mr. Wajid-ur-Rehman, Assistant Private Secretary (RO-11), Drug Licensing Division, DRAP in addition to his own duties.

4. This issues with the approval of the competent authority.

HAMZA ZUBAID MALIK,  
Assistant Director (Admn-I).

MINISTRY OF OVERSEAS PAKISTANIS AND HUMAN  
RESOURCE DEVELOPMENT

Islamabad, the 2nd June, 2020

**No. 2(41)/2020-Admn-I.**—In exercise of the powers conferred under Rule 4(2) of the Civil Servants (Directory Retirement from Service) Rules, 2020 the following Retirement Committee is constituted to review the cases for the purpose of Directory Retirement in respect of Civil Servants in BS-17 to 19:-

a)	Mr. Tassaduq Hussain, Joint Secretary (BPS-20) M/o. OP&HRD	Chairperson
b)	Representative of Establishment Division not below BPS-20	Member
c)	Representative of Finance Division not below BPS-20	Member
d)	Mr. Muhammad Israr, Additional Draftsman (BPS-20) M/o. Law & Justice	Member
e)	Mir Rahman, Deputy Secretary (BPS-19) M/o. OP&HRD.	Secretary

2. This issues with the approval of the competent authority.

**No. 2(41)/2020-Admn-I.**—In exercise of the powers conferred under Rule 4(3) of the Civil Servants (Directory Retirement from Service) Rules, 2020 the following Retirement Committee is constituted to review the cases for the purpose of Directory Retirement in respect of Civil Servants in BS-16 and below:-

a)	Mr. Tassaduq Hussain, Joint Secretary (BPS-20) M/o. OP&HRD	Chairperson
b)	Representative of Establishment Division not below BPS-19	Member
c)	Representative of Finance Division not below BPS-19	Member
d)	Mr. Muhammad Israr, Additional Draftsman (BPS-20) M/o. Law and Justice	Member
e)	Mir Rahman, Deputy Secretary (BPS-19) M/o. OP&HRD.	Secretary

2. This issues with the approval of the competent authority.

SAQIB ALI KHAN,  
Section Officer (Admn-I).

---

MINISTRY OF RAILWAYS

[RAILWAY BOARD]

Islamabad, the 9th June, 2020

**No. Admn-IV/19-TR/3.**—In terms of Establishment Division's Notification No.1-39/2012-E-2 dated 4th June, 2020, Mr. Mustaeen Ahmed Alvi, a BS-19 Officer of the Secretariat Group has assumed the charge of the post of Director/ Establishment (BS-19), Ministry of Railways, Islamabad on deputation basis for a period of three years with effect from 5th June, 2020 on usual terms and conditions.

FAHEEM AHMED MALIK,  
Assistant Director/ Admn-IV.

---

MINISTRY OF RELIGIOUS AFFAIRS AND  
INTERFAITH HARMONY

Islamabad, the 3rd June, 2020

**No. F.9(260)/2020-Admn.**—In pursuance of Establishment Division's Notification No.PF(594)/E-5(PAS), dated 2nd June, 2020, Sardar Ajaz Ahmad Khan Jaffar, a BS-22 Officer of Pakistan Administrative Services, has

assumed the charge of the post of Secretary (BS-22), in the Ministry of Religious Affairs and Interfaith Harmony, Government of Pakistan, Islamabad with effect from 3rd June, 2020.

AZIZULLAH KHAN,  
Section Officer.

---

MINISTRY OF SCIENCE & TECHNOLOGY

Islamabad, the 4th June, 2020

**No. 3(12)/2019-Estt-II.**—With the approval of Additional Secretary, Ministry of Science & Technology, Mr. Ashar Mahmood, Section Officer (Org-III) (BS-17) of this Ministry is assigned additional charge of the post of Section Officer (BS-17) (Org-II) for a period of three months with effect from 3rd June, 2020 or till the joining of regular incumbent of the post, whichever is earlier.

SHAKIL ARSHAD,  
Deputy Secretary (Admn).

---

NATIONAL ASSEMBLY SECRETARIAT

Islamabad, the 2nd July, 2020

**No. G(572)/Estt-I(111).**—Mr. Khizer Hayat, Protocol Officer (BS-16) in the National Assembly Secretariat is granted 19 days LFP with effect from 6th July, 2020 with permission to prefix Saturday & Sunday, the 4th & 5th July, 2020 and suffix Saturday & Sunday, the 25th & 26th July, 2020.

On expiry of the above leave, he is expected to resume his duties on 27th July, 2020.

Islamabad, the 6th July, 2020

**No. F.1(4)/2019-HRD(112).**—After attending 29th Mid Career Management Course at National Institute of Management, Peshawar, Mr. Muhammad Farooq, Section Officer (BS-18) in the National Assembly Secretariat has resumed the charge of the same post at Islamabad on 3rd July, 2020. He was relieved for the purpose *vide* this Secretariat's Notification No.F.1(4)/2019-HRD(98), dated 20th May, 2020.

**No. F.1(4)/2019-HRD(113).**—After attending 29th Mid Career Management Course at National Institute of Management, Peshawar, Ms. Tahira Rasool, Section Officer (BS-18) in the National Assembly Secretariat has resumed the charge of the same post at Islamabad on 3rd July, 2020. She was relieved for the purpose *vide* this Secretariat's Notification No.F.1(4)/2019-HRD(97), dated 20th May, 2020.

MUHAMMAD YASEEN SALEEMI,  
Deputy Secretary.

## SENATE SECRETARIAT

This issues with the approval of Chairman Senate.

Islamabad, the 2nd July, 2020

ZAHOOR AHMED,  
Section Officer (HRM-I).

**No. M(453)/2004-HRM(79).**—The competent authority has been pleased to terminate the probation period of Mr. Faisal Gulzar, Private Secretary (BPS-17), Senate Secretariat, Islamabad, with effect from 29th May, 2020.

Islamabad, the 6th July, 2020

**No. F.3(1)/2020-HRM(82).**—Having been selected for the post of Assistant Director (IT) (BPS-17) against the advertised vacancy, Mr. Farhat Hayat S/o. Khizar Hayat is appointed as Assistant Director (IT) in BPS-17 viz Rs.30,370,2,300-76,370, plus usual allowances, as admissible to the Federal Government Employees, from time to time, in the Senate Secretariat with effect from 2nd July, 2020.

He shall be on probation for a period of two years or otherwise as provided in Rule-21(2) of the Civil Servants (APT) Rules, 1973.

The other terms and conditions of his appointment will be the same as conveyed to him *vide* Senate Secretariat's Memorandum No.F.3(1)/2020-HRM, dated the 2nd June, 2020.

Islamabad, the 7th July, 2020

**No. F.24/923/2020-SCA.**—Mr. Asad Ullah Khan S/o. Ahmed Wali Khan is appointed as Assistant Private Secretary (BS-16) to Mr. Justice Anwar Zaheer Jamali, Hon'ble Former Chief Justice of Pakistan in this Court, with effect from 1st July, 2020, on the following terms and conditions:-

1.	Post	Assistant Private Secretary (BS-16)
2.	Place of Posting	With Mr. Justice Anwar Zaheer Jamali, Hon'ble Former Chief Justice of Pakistan or anywhere as the competent authority may decide.
3.	Period of contract	Two years w.e.f. 1st July, 2020 and will be valid only during life time of Mr. Justice Anwar Zaheer Jamali, Former HCJ
4.	Pay & Allowances	You will draw your salary in basic pay scale No.16 viz: Rs.18910-1520-64510 plus other usual allowances as may be admissible to your class of officials under the Supreme Court of Pakistan, from time to time
5.	Travelling Allowance	As admissible to officials of Supreme Court of Pakistan/ Civil Servants of the corresponding pay scale under the rules.
6.	Seniority	This contract appointment does not confer any right for being placed in the gradation/seniority list of the Cadre / Group to which the subject post belongs.
7.	Leave	As admissible under the Federal Government Revised Leave Rules, 1980. However, provisions contained in Rules 5(c), 8, 11, 14, 16, 17, 18, 18-A, 19, 27, 33, 34, 35, 36 & 39 of Rules <i>ibid</i> shall not apply.

## SUPREME COURT OF PAKISTAN

Islamabad, the 3rd July, 2020

**No. F.25/295/79-SCA.**—On attaining the age of superannuation, Mr. Zarif Ali, Senior Assistant (BS-16) of this Court shall stand retired from Government Service with effect from 10th October, 2020.

This issues with the approval of the competent authority.

Islamabad, the 4th July, 2020

**No. F.24/886/2018-SCA.**—Mr. Muhammad Owais, Director (BS-19) of this Court is granted eighteen (18) days' leave on full pay with effect from 3rd June, 2020 to 20th June, 2020 on medical grounds, subject to verification of title of his leave account by the AGPR, Islamabad.

**No. F.24/844/2016-SCA.**—Mr. Manzoor Hussain, Judicial Assistant (BS-16) of this Court is granted eleven (11) days' leave on full pay with effect from 27th May, 2020 to 6th June, 2020 on medical grounds, subject to verification of title of his leave account by the AGPR, Islamabad.



8.	Medical Facilities	As admissible to officers of the Supreme Court of Pakistan under the Rules provided that you are not availing medical facility under Government already.
9.	Pension	Service rendered under this contract shall not qualify for a pension or gratuity.
10.	General Provident Fund	No contribution towards G.P Fund shall be required.
11.	Conduct and Discipline	Supreme Court Establishment Service Rules, 2015 and instructions issued by the Supreme Court of Pakistan/ Federal Government or a prescribed authority shall apply.
12.	Appeal	Supreme Court Establishment Service Rules, 2015, shall apply.
13.	Termination of Contract	The appointment during the period of contract shall be liable to termination on 30 days notice on either side or payment of basic pay in lieu thereof, without assigning any reason.
14.	Whole time Employment posting and transfer	whole time of the contract appointee would be at the disposal of the Hon'ble Former Chief Justice of Pakistan. You may be employed in any manner required by his lordship without claim for additional remuneration. You shall at all times obey the Rules prescribed for the time being for the regulation of the service or Cadre to which the post in which you have been employed belongs.
15.	Other matters	In respect of other matters not specified in this contract, the rules/ regulations as applicable to Supreme Court Employees/ Civil Servants shall apply.
16.	Accommodation	Same facility of Government owned or hired residence as is admissible to persons of corresponding grade.

PERVAIZ IQBAL,  
Assistant Registrar (Admn).

FEDERAL JUDICIAL ACADEMY

Islamabad, the 24th June, 2020

**No. F.24(6)/1990-FJA.**—In supersession of this Academy Notification dated 14th March, 2020, the sanctioned leave of 08 days on full pay granted to Mr. Zaheer Abbas, SPS (BPS-19) from 24th March, 2020 to 31st March, 2020 is hereby cancelled owing to lock down in Federal Capital as a precautionary measure against the spread of Corona Virus (Covid-19).

TAHIR IQBAL,  
Administrative Officer.

# The Gazette of Pakistan

PUBLISHED BY AUTHORITY

KARACHI, WEDNESDAY, JULY 15, 2020

## PART II

### Notifications issued by Ministry of Defence and Ministry of Defence Production

Karachi, the 15th July, 2020

MINISTRY OF DEFENCE

(Defence Division)

No. 326/2020 :

The following 09 officers have been granted Direct Short Service Commission (DSSC) in the Pakistan Land Forces Army Education Corps and antedate of seniority, with effect from the dates as mentioned against each. The antedate of seniority will be counted for the purpose of seniority, promotion and increment :-

S. No.	PSS No.	Rank	Name	Arms/ Svcs.	Date of DSSC	Ante date Seniority
1.	PSS-59712	Capt.	Israr Ahmad Kundi	AEC	14-10-2018	13-05-2018
2.	PSS-59713	Capt.	Muhammad Faizan	AEC	14-10-2018	13-05-2018
3.	PSS-59714	Capt.	Umer Sheryar	AEC	14-10-2018	13-05-2018
4.	PSS-59715	Capt.	Waqas Sattar	AEC	14-10-2018	13-05-2018
5.	PSS-59716	Capt.	Muhammad Hussain	AEC	14-10-2018	13-05-2018
6.	PSS-59717	Capt.	Hafiz Usman Sabir	AEC	14-10-2018	13-05-2018
7.	PSS-59718	Capt.	Rehan Ali	AEC	14-10-2018	13-05-2018
8.	PSS-59719	Capt.	Muhammad Bilal	AEC	14-10-2018	13-05-2018
9.	PSS-59720	Capt.	Misbah-ud-Din	AEC	14-10-2018	13-05-2018

[No. F. 5/4/D-2(A-II)/2020].

**No. 327/2020 :**

The following 09 officers have been granted Direct Short Service Commission (DSSC) in the Pakistan Land Forces Ordnance, Army Education Corps and General List and antedate of seniority, with effect from the dates as mentioned against each. The antedate of seniority will be counted for the purpose of seniority, promotion and increment :-

S. No.	PSS No.	Rank	Name	Arms/ Svcs.	Date of DSSC	Ante date Seniority
1.	PSS-60978	Capt.	Hasham Tahir	GL/FF	13-10-2019	13-05-2019
2.	PSS-60979	Capt.	Muhammad Rustam Khan	Ord.	13-10-2019	13-05-2019
3.	PSS-60980	Capt.	Ali Hassan	AEC	13-10-2019	13-05-2019
4.	PSS-60981	Capt.	Aamir Haroon	AEC	13-10-2019	13-05-2019
5.	PSS-60982	Capt.	Mirza Waseem Sajjad	GL/AK	13-10-2019	13-05-2019
6.	PSS-60983	Capt.	Muhammad Shayan Khalid	AEC	13-10-2019	13-05-2019
7.	PSS-60984	Capt.	Gulfam Yousaf	GL/Sindh	13-10-2019	13-05-2019
8.	PSS-60985	Capt.	Muhammad Mukhdoom Bin Jaffar.	AEC	13-10-2019	13-05-2019
9.	PSS-60986	Capt.	Abdul Ghaffar	AEC	13-10-2019	13-05-2019

[No. F. 5/4/D-2(A-II)/2020].

**No. 328/2020 :**

The following 90 officers have been granted Short Service Regular Commission (SSRC) in the Pakistan Army, with effect from the date as mentioned against each :-

S. No.	PSS No.	Rank	Name	Arms/ Svcs.	Date of SSRC	Ante date Seniority
1.	PSS-106584	Capt.	Nida	AMC	13th October, 2018	-
2.	PSS-106585	Capt.	Faryal Raana	AMC	13th October, 2018	-
3.	PSS-106586	Capt.	Ammarah Ghafoor	AMC	13th October, 2018	-
4.	PSS-106587	Capt.	Sohail Ahmed	AMC	13th October, 2018	-
5.	PSS-106588	Capt.	Samina Rubab	AMC	13th October, 2018	-
6.	PSS-106589	Capt.	Hira Salam	AMC	13th October, 2018	-
7.	PSS-106590	Capt.	Ali Raza	AMC	13th October, 2018	-

S. No.	PSS No.	Rank	Name	Arms/ Svcs.	Date of SSRC	Ante date Seniority
8.	PSS-106591	Capt.	Huma Shehzadi	AMC	13th October, 2018	-
9.	PSS-106592	Capt.	Maria Kanwal	AMC	13th October, 2018	-
10.	PSS-106593	Capt.	Jawwad Shahid	AMC	13th October, 2018	-
11.	PSS-106594	Capt.	Fatima Mahmood	AMC	13th October, 2018	-
12.	PSS-106595	Capt.	Anoosha Zafar	AMC	13th October, 2018	-
13.	PSS-106596	Capt.	Hannan Chaudhry	AMC	13th October, 2018	-
14.	PSS-106597	Capt.	Sauman Mushtaq	AMC	13th October, 2018	-
15.	PSS-106598	Capt.	Daheem Nusrat	AMC	13th October, 2018	-
16.	PSS-106599	Capt.	Ali Raza	AMC	13th October, 2018	-
17.	PSS-106600	Capt.	Rabia Afroz	AMC	13th October, 2018	-
18.	PSS-106601	Capt.	Ayra Arshad	AMC	13th October, 2018	-
19.	PSS-106602	Capt.	Hussaan Ullah	AMC	13th October, 2018	-
20.	PSS-106603	Capt.	Suffia Hayee	AMC	13th October, 2018	-
21.	PSS-106604	Capt.	Muhammad Asif Hayat	AMC	13th October, 2018	-
22.	PSS-106605	Capt.	Wazir Fairuze Ahmad	AMC	13th October, 2018	-
23.	PSS-106606	Capt.	Asif Rasool Mughal	AMC	13th October, 2018	-
24.	PSS-106607	Capt.	Aamir Irshad	AMC	13th October, 2018	-
25.	PSS-106608	Capt.	Sania Khalid Badini	AMC	13th October, 2018	-
26.	PSS-106609	Capt.	Rahat Kalsoom	AMC	13th October, 2018	-
27.	PSS-106610	Capt.	Wajahat Farid	AMC	13th October, 2018	-
28.	PSS-106611	Capt.	Muhammad Sajid Ul Haq	AMC	13th October, 2018	-

S. No.	PSS No.	Rank	Name	Arms/ Svcs.	Date of SSRC	Ante date Seniority
29.	PSS-106612	Capt.	Yousaf Shah	AMC	13th October, 2018	-
30.	PSS-106613	Capt.	Syed Ahsan Azeem	AMC	13th October, 2018	-
31.	PSS-106614	Capt.	Zahid Qayyum Qureshi	AMC	13th October, 2018	-
32.	PSS-106615	Capt.	Farhad Mustafa	AMC	13th October, 2018	-
33.	PSS-106616	Capt.	Muhammad Ali Maqsood	AMC	13th October, 2018	-
34.	PSS-106617	Capt.	Muhammad Ali	AMC	13th October, 2018	-
35.	PSS-106618	Capt.	Muhammad Tayyab	AMC	13th October, 2018	-
36.	PSS-106619	Capt.	Shahzaib Shaukat	AMC	13th October, 2018	-
37.	PSS-106620	Capt.	Muhammad Abu Baker Khan	AMC	13th October, 2018	-
38.	PSS-106621	Capt.	Faizan Badar	AMC	13th October, 2018	-
39.	PSS-106622	Capt.	Razi Ur Rehman	AMC	13th October, 2018	-
40.	PSS-106623	Capt.	Danish Ali Mir	AMC	13th October, 2018	-
41.	PSS-106624	Capt.	Kamran Habib	AMC	13th October, 2018	-
42.	PSS-106625	Capt.	Sufyan Rauf	AMC	13th October, 2018	-
43.	PSS-106626	Capt.	Aasim Ali Sajid	AMC	13th October, 2018	-
44.	PSS-106627	Capt.	Muhammad Faraz	AMC	13th October, 2018	-
45.	PSS-106628	Capt.	Jawad Ullah Baig	AMC	13th October, 2018	-
46.	PSS-106629	Capt.	Abdullah Aftab	AMC	13th October, 2018	-
47.	PSS-106630	Capt.	Jamal Abdul Nasir Kayani	AMC	13th October, 2018	-
48.	PSS-106631	Capt.	Arslan Ali	AMC	13th October, 2018	-
49.	PSS-106632	Capt.	Abu Bakar Siddiqui	AMC	13th October, 2018	-

S. No.	PSS No.	Rank	Name	Arms/ Svcs.	Date of SSRC	Ante date Seniority
50.	PSS-106633	Capt.	Kaleem Ullah	AMC	13th October, 2018	-
51.	PSS-106634	Capt.	Afzal Shabbir	AMC	13th October, 2018	-
52.	PSS-106635	Capt.	Muhammad Ashraf	AMC	13th October, 2018	-
53.	PSS-106636	Capt.	Sardar Saad Ahmed Mir	AMC	13th October, 2018	-
54.	PSS-106637	Capt.	Ayesha Khalique	AMC	13th October, 2018	-
55.	PSS-106638	Capt.	Abaid Ullah Shoukat	AMC	13th October, 2018	-
56.	PSS-106639	Capt.	Adnan Amjad Malik	AMC	13th October, 2018	-
57.	PSS-106640	Capt.	Rao Sadaqat Ali Khan	AMC	13th October, 2018	-
58.	PSS-106641	Capt.	Kashif Ali Chattha	AMC	13th October, 2018	-
59.	PSS-106642	Capt.	Kashif Ali	AMC	13th October, 2018	-
60.	PSS-106643	Capt.	Muhammad Mohsin Hayat	AMC	13th October, 2018	-
61.	PSS-106644	Capt.	Faisal Hussain	AMC	13th October, 2018	-
62.	PSS-106645	Capt.	Haroon Tariq	AMC	13th October, 2018	-
63.	PSS-106646	Capt.	Hammad Ul Hassan	AMC	13th October, 2018	-
64.	PSS-106647	Capt.	Muhammad Tayyab	AMC	13th October, 2018	-
65.	PSS-106648	Capt.	Sana Ullah	AMC	13th October, 2018	-
66.	PSS-106649	Capt.	Muhammad Urvah Akmal	AMC	13th October, 2018	-
67.	PSS-106650	Capt.	Hamza Afridi	AMC	13th October, 2018	-
68.	PSS-106651	Capt.	Sajjad Mehmood Ali	AMC	13th October, 2018	-
69.	PSS-106652	Capt.	Majid Ali	AMC	13th October, 2018	-
70.	PSS-106653	Capt.	Ali Afzal	AMC	13th October, 2018	-

S. No.	PSS No.	Rank	Name	Arms/ Svcs.	Date of SSRC	Ante date Seniority
71.	PSS-106654	Capt.	Raheel Quder	AMC	13th October, 2018	-
72.	PSS-106655	Capt.	Malik Awais Abdullah	AMC	13th October, 2018	-
73.	PSS-106656	Capt.	Waris Hussain	AMC	13th October, 2018	-
74.	PSS-106657	Capt.	Malik Musawar Nazir	AMC	13th October, 2018	-
75.	PSS-106658	Capt.	Muhammad Ashir	AMC	13th October, 2018	-
76.	PSS-106659	Capt.	Muhammad Usman Asad	AMC	13th October, 2018	-
77.	PSS-106660	Capt.	Muhammad Mustafa	AMC	13th October, 2018	-
78.	PSS-106661	Capt.	Rafi Ud Din	AMC	13th October, 2018	-
79.	PSS-106662	Capt.	Muhammad Saad Naseer	AMC	13th October, 2018	-
80.	PSS-106663	Capt.	Hannan Ahmad	AMC	13th October, 2018	-
81.	PSS-106664	Capt.	Hussain Tariq Sahi	AMC	13th October, 2018	-
82.	PSS-106665	Capt.	Muhammad Bilal	AMC	13th October, 2018	-
83.	PSS-106666	Capt.	Shakir Ullah Khan	AMC	13th October, 2018	-
84.	PSS-106667	Capt.	Muhammad Sohaib	AMC	13th October, 2018	-
85.	PSS-106668	Capt.	Muneeb Ahmed Mir	AMC	13th October, 2018	-
86.	PSS-106669	Capt.	Khadim Hussain	AMC	13th October, 2018	-
87.	PSS-106670	Capt.	Jawad Khalid	AMC	13th October, 2018	-
88.	PSS-106671	Capt.	Mohsin Ahmad Qayyum	AMC	13th October, 2018	-
89.	PSS-106672	Capt.	Muhammad Moiz Khan	AMC	13th October, 2018	-
90.	PSS-106673	Capt.	Hafiz Ahmed Sajid	AMC	13th October, 2018	-

**No. 329/2020 :**

The following 72 officers have been granted Short Service Regular Commission (SSRC) in the Pakistan Army, with effect from the date as mentioned against each :-

S. No.	PSS No.	Rank	Name	Arms/ Svcs.	Date of SSRC	Ante date Seniority
1.	PSS-106821	Capt.	Nida Khan	AMC	13-10-2019	-
2.	PSS-106822	Capt.	Naveen Sheikh	AMC	13-10-2019	-
3.	PSS-106823	Capt.	Bushra Arif	AMC	13-10-2019	-
4.	PSS-106824	Capt.	Syeda Fatima Raza	AMC	13-10-2019	-
5.	PSS-106825	Capt.	Tayyaba Manzoor	AMC	13-10-2019	-
6.	PSS-106826	Capt.	Muhammad Wasim Ahmed	AMC	13-10-2019	-
7.	PSS-106827	Capt.	Hafsa Ashraf	AMC	13-10-2019	-
8.	PSS-106828	Capt.	Talia Amjad	AMC	13-10-2019	-
9.	PSS-106829	Capt.	Amina Ali	AMC	13-10-2019	-
10.	PSS-106830	Capt.	Hafsa Amjad	AMC	13-10-2019	-
11.	PSS-106831	Capt.	Mishail Saadat	AMC	13-10-2019	-
12.	PSS-106832	Capt.	Sheeza Khalid	AMC	13-10-2019	-
13.	PSS-106833	Capt.	Khurram Shahzad	AMC	13-10-2019	-
14.	PSS-106834	Capt.	Maham Shah	AMC	13-10-2019	-
15.	PSS-106835	Capt.	Muhammad Saim Iqbal	AMC	13-10-2019	-
16.	PSS-106836	Capt.	Muhammad Hassaan Naeem Chaudhry.	AMC	13-10-2019	-
17.	PSS-106837	Capt.	Bilal Rasheed	AMC	13-10-2019	-
18.	PSS-106838	Capt.	Maryam Zia Bajwa	AMC	13-10-2019	-
19.	PSS-106839	Capt.	Maroona Syed	AMC	13-10-2019	-



S. No.	PSS No.	Rank	Name	Arms/ Svcs.	Date of SSRC	Ante date Seniority
20.	PSS-106840	Capt.	Adil	AMC	13-10-2019	-
21.	PSS-106841	Capt.	Sana Ullah Khan	AMC	13-10-2019	-
22.	PSS-106842	Capt.	Danish Bilal Ahmed	AMC	13-10-2019	-
23.	PSS-106843	Capt.	Muhammad Rameez	AMC	13-10-2019	-
24.	PSS-106844	Capt.	Asif Qadar Shahan	AMC	13-10-2019	-
25.	PSS-106845	Capt.	Ali Armughan Khan	AMC	13-10-2019	-
26.	PSS-106846	Capt.	Amina Sami	AMC	13-10-2019	-
27.	PSS-106847	Capt.	Muhammad Noman Sajjad Cheema.	AMC	13-10-2019	-
28.	PSS-106848	Capt.	Sohail Ahmed	AMC	13-10-2019	-
29.	PSS-106849	Capt.	Muhammad Zul Hasnain Falak.	AMC	13-10-2019	-
30.	PSS-106850	Capt.	Sajjad Ahmad	AMC	13-10-2019	-
31.	PSS-106851	Capt.	Muhammad Haroon Khan	AMC	13-10-2019	-
32.	PSS-106852	Capt.	Wasif Yasin	AMC	13-10-2019	-
33.	PSS-106853	Capt.	Badruddin	AMC	13-10-2019	-
34.	PSS-106854	Capt.	Umar Javed	AMC	13-10-2019	-
35.	PSS-106855	Capt.	Hafiz Muhammad Hamza Arshad.	AMC	13-10-2019	-
36.	PSS-106856	Capt.	Muhammad Bilal Shehzad	AMC	13-10-2019	-
37.	PSS-106857	Capt.	Bushra Sattar	AMC	13-10-2019	-
38.	PSS-106858	Capt.	Talha Arshad	AMC	13-10-2019	-
39.	PSS-106859	Capt.	Hafiz Syed Ali Arsalan Alam	AMC	13-10-2019	

S. No.	PSS No.	Rank	Name	Arms/ Svcs.	Date of SSRC	Ante date Seniority
40.	PSS-106860	Capt.	Raja Sohaib Abdur Rehman	AMC	13-10-2019	-
41.	PSS-106861	Capt.	Ahmed Hamza	AMC	13-10-2019	-
42.	PSS-106862	Capt.	Huzefa Ahmed	AMC	13-10-2019	-
43.	PSS-106863	Capt.	Muhammad Ejaz-Ur-Rehman Khan.	AMC	13-10-2019	-
44.	PSS-106864	Capt.	Jahangeer Hussain	AMC	13-10-2019	-
45.	PSS-106865	Capt.	Saddam Hussain	AMC	13-10-2019	-
46.	PSS-106866	Capt.	Muhammad Junaid	AMC	13-10-2019	-
47.	PSS-106867	Capt.	Muhammad Basit Sheikh	AMC	13-10-2019	-
48.	PSS-106868	Capt.	Shahzad Ahmed	AMC	13-10-2019	-
49.	PSS-106869	Capt.	Muhammad Husnain	AMC	13-10-2019	-
50.	PSS-106870	Capt.	Talha Kazi	AMC	13-10-2019	-
51.	PSS-106871	Capt.	Raja Ehtasham Bashir Khan	AMC	13-10-2019	-
52.	PSS-106872	Capt.	Syed Sohail Kazmi	AMC	13-10-2019	-
53.	PSS-106873	Capt.	Muhammad Ali Haider Jarral	AMC	13-10-2019	-
54.	PSS-106874	Capt.	Muhammad Asad Azim Khan	AMC	13-10-2019	-
55.	PSS-106875	Capt.	Bahram Khan	AMC	13-10-2019	-
56.	PSS-106876	Capt.	Murtaza Ayaz	AMC	13-10-2019	-
57.	PSS-106877	Capt.	Muhammad Faisal Umair Khan.	AMC	13-10-2019	-
58.	PSS-106878	Capt.	Ch. Muhammad Jehanzaib Ali.	AMC	13-10-2019	-
59.	PSS-106879	Capt.	Muhammad Hamza Ali	AMC	13-10-2019	-

S. No.	PSS No.	Rank	Name	Arms/ Svcs.	Date of SSRC	Ante date Seniority
60.	PSS-106880	Capt.	Muhamamd Talal Ayoub Khan.	AMC	13-10-2019	-
61.	PSS-106881	Capt.	Shahzaib Waheed	AMC	13-10-2019	-
62.	PSS-106882	Capt.	Abdur Rehman	AMC	13-10-2019	-
63.	PSS-106883	Capt.	Muhammad Ismail Dars	AMC	13-10-2019	-
64.	PSS-106884	Capt.	Sadiq Shah	AMC	13-10-2019	-
65.	PSS-106885	Capt.	Bilal Hayat	AMC	13-10-2019	-
66.	PSS-106886	Capt.	Awais	AMC	13-10-2019	-
67.	PSS-106887	Capt.	Adeel Ahmad	AMC	13-10-2019	-
68.	PSS-106888	Capt.	Mian Hussnain Ali	AMC	13-10-2019	-
69.	PSS-106889	Capt.	Waleed Khalid	AMC	13-10-2019	-
70.	PSS-106890	Capt.	Mujeeb Ur Rehman	AMC	13-10-2019	-
71.	PSS-106891	Capt.	Rizwan Nazir	AMC	13-10-2019	-
72.	PSS-106892	Capt.	Younas Khan	AMC	13-10-2019	-

[No. F. 5/3/D-2(A-II)/2020].

IKRAM UL HAQ, Lt. Gen. (Retd.),  
Secretary.

## MINISTRY OF DEFENCE PRODUCTION

The officer shall remain on probation for the period of one year.

**No. 330/2020 :**

[No. 8/17/DP-9/2016].

Consequent upon recommendations of Departmental Selection Board (DSB) of MoDP in a meeting held on 23rd April, 2020 under the Chairmanship of Secretary Defence Production and with the approval of competent authority, Mr. Khalid Hussain, Deputy Production Manager (BPS-18), is hereby promoted to the post of Production Manager (BPS-19), in Institute of Optronics against existing vacancy reserved for promotion with immediate effect.

RAJA TANVEER AZMI,  
Deputy Secretary.**No. 331/2020 :**

The competent authority has approved promotion of following officers of POFs from BS-19 to BS-20, with effect from 20th March, 2020 :-

<b>S. No.</b>	<b>PL No. &amp; Name</b>	<b>Promoted as</b>	<b>No. 332/2020 :</b>
a.	No. 984815 Mr. Muhammad Taufeeq	Director (Admin.)	In pursuance of Establishment Division's Notification No. F.6/1/2019-E-VII, dated 31st March, 2020, Mr. Muhammad Amjad Alam Sher Malik has assumed the charge of the post of Section Officer (BPS-17), in Ministry of Defence Production, Rawalpindi on 1st April, 2020.
b.	No. 986091 Mr. Kaleem Ahmad	MD/Director (Chemical).	
c.	No. 98521 Syed Qaiser Mehmood	MD/Director (Technical)	
d.	No. 986216 Mr. Muhammad Hussain	MD/Director (Technical)	[No. 2/4/2020/DP-2].
e.	No. 986315 Mr. Ilyas Naveed	MD/Director (Technical)	In pursuance of Establishment Division's Notification No. F. 6/1/2019-E-VII, dated 31st March, 2020, Mr. Muhammad Arfan has assumed the charge of the post of Section Officer (BPS-17), in Ministry of Defence Production, Rawalpindi on 1st April, 2020.
f.	No. 986331 Mr. Shafiq Ahmed	MD/Director (Technical)	
g.	No. 986448 Mr. Gohar Kamal Ayub	MD/Director (Technical)	
			[No. 2/4/2020/DP-2].
		[No. 10/27/DP-7/2018].	

MUHAMMAD TAHIR,  
Section Officer.

MUHAMMAD MOOSA,  
Section Officer.

# The Gazette of Pakistan

PUBLISHED BY AUTHORITY

KARACHI, WEDNESDAY, JULY 15, 2020

## PART III

Notifications issued by the High Courts, the Federal Public Service Commission and by the Attached and Subordinate Offices of the Government of Pakistan.

FEDERAL PUBLIC SERVICE COMMISSION

Islamabad, the 7th April, 2020

**No. F. 16-102/87-Estt-Vol-IV.**—In pursuance of Establishment Division's Letter No. F. 1/4/2020-T-I, dated 2nd April, 2020, Mr. Kamran Raffat, Deputy Director (BS-18), FPSC has joined Federal Public Service Commission, Islamabad with effect from 3rd April, 2020.

MUHAMMAD ASGHAR,  
Assistant Director (HR).

DIRECTORATE GENERAL OF REFORMS & AUTOMATION  
(CUSTOMS)

Islamabad, the 12th March, 2020

**No. R&A. 5/leave/2019/20-132.**—Ms. Nawabzadi Aliya Khanji, Additional Director (BS-19), Directorate of Reforms & Automation, (Customs), Karachi is hereby granted 45 (forty five) days earned leave with effect from 19th February, 2020 to 5th April, 2020. The officer will join her duties at her present place of posting after expiry of leave period.

This issues with the approval of the Director General, Directorate General of Reforms & Automation (Customs), Islamabad in exercise of the powers delegated *vide* Board's Notification No. 1(29)/2011-MIR-II (pt) dated 29th October, 2018.

RASHID MUNIR SIDDIQUI,  
Additional Director.

COUNCIL OF ISLAMIC IDEOLOGY

Islamabad, the 31st March, 2020

**No. F. 3(5)/2007-Admn-CII/55.**—Consequent upon recommendations of the Departmental Selection/Promotion Board (DSB/DPB) made in its meeting held on 24th March, 2020 and with the approval of the competent authority *i.e.* the Chairman, Council of Islamic Ideology, Mr. Abdul Rashid, Research Officer (BS-17) is hereby promoted to the vacant post of Senior Research Officer (BS-18) with effect from 28th October, 2019. He is placed on probation for a period of one year with effect from 28th October, 2019, which may be extended for a period not exceeding one year.

**No. F. 3(5)/2007-Admn-CII/56.**—Consequent upon recommendations of the Departmental Selection/Promotion Board (DSB/DPB) made in its meeting held on 24th March, 2020 and with the approval of the competent authority *i.e.* the Chairman, Council of Islamic Ideology, Dr. Ghulam Dastgeer Shaheen, Senior Research Officer (BS-18) is hereby promoted to the vacant post of Chief Research Officer (BS-19) with effect from 28th October, 2019. He is placed on probation for a period of one year with effect from 28th October, 2019, which may be extended for a period not exceeding one year.

MUHAMMAD ATIQ-UR-RAHMAN,  
Deputy Director (Admn/HR).

DIRECTORATE GENERAL OF SPECIAL EDUCATION

Islamabad, the 31st March, 2020

**No. PF. 1607 (MA)/A-II.**—After availing 10 days leave with full pay with effect from 9th March, 2020 to 18th March, 2020, Mr. Muhammad Arshad, Deputy Chief Librarian (BPS-18) has assumed the charge of the post of Deputy Chief Librarian (BPS-18) in the National Library and Resource Centre under the Directorate General of Special Education, Islamabad on 19th March, 2020.

The officer also relinquished the charge of the post of Deputy Chief Librarian (BPS-18) from National Library and Resource Centre, Islamabad on 6th March, 2020 (7th & 8th March, 2020 being Saturday & Sunday).

**No. PF. 834 (SMH)/A-II.**—After availing 38 days leave with full pay with effect from 11th February, 2020 to 19th March, 2020 and curtailing 42 days leave with full pay with effect from 20th March, 2020 to 30th April, 2020, Syed Manzar Hassan Gerdazi, Deputy Director (BPS-18) has assumed the charge of the post of Deputy

Director (Admin-IV/Legal) in the Directorate General of Special Education, Islamabad on 20th March, 2020.

The officer also relinquished the charge of the post of Deputy Director (Admin-IV/Legal) (BPS-18) from Directorate General of Special Education, Islamabad on 10th February, 2020.

**No. PF. 843 (SN)/A-II.**—Dr. Samina Zafar, Audiologist, (BS-18), National Special Education Centre for Hearing Impaired Children, Islamabad under the Directorate General of Special Education, Islamabad is granted 15 days Rest and Recreation Leave with effect from 24th March, 2020 to 7th April, 2020 in lieu of 10 days L.F.P.

On expiry of leave the officer is likely to assume the charge of the same post and at the same station.

**No. PF. 522 (ZK)/A-II.**—After availing 26 days ex-Pakistan along with NOC to visit Saudi Arabia with effect from 10th February, 2020 to 6th March, 2020, Mrs. Zubaida Khanum, Senior Teacher has assumed the charge of the post of Senior Teacher (BPS-18) in the National Special Education Centre for Hearing Impaired Children, Islamabad under the Directorate General of Special Education, Islamabad on 9th March, 2020 (7th & 8th March, 2020 being Saturday and Sunday).

DR. AHMED NADEEM,  
Deputy Director (Admin).

[VOCATIONAL REHABILITATION & EMPLOYMENT OF DISABLED PERSONS]

Islamabad, the 3rd March, 2020

**No. F. 1-44(AMK)/2009-VREDP(SC-I).**—Mr. Aqib Mehmood Khan, Senior Vocational Instructor (BPS-16) in the Service Centre-I, VREDP Islamabad is granted 11 days LFP (leave on full pay) with effect from 3rd March, 2020 to 13th March, 2020 subject to title.

On expiry of leave the officer is likely to resume the duty on the same post and at the same station.

This issues with the approval of Director (T&R/SE) DGSE, Islamabad.

ZAFAR KHAN KHATTAK,  
Deputy Director (Admin).

FEDERAL DIRECTORATE OF EDUCATION

[ISLAMABAD COLLEGE FOR GIRLS]

Islamabad, the 10th March, 2020

**No. F. 25-LECT(ICG)/PC-271.**—Ms. Hina Shafique, Lecturer, BPS-17 (P # 50087975) of this Institution is hereby granted 45-days Maternity Leave (Post-Confinement) with effect from 12th March, 2020 to 25th April, 2020 on full pay on medical grounds.

On the expiry of leave, the above named Government Servant is expected to resume her duty on the same station.

This is issued with the approval of competent authority.

Islamabad, the 11th March, 2020

**No. F. 22-ST(ICG)/PC-267.**—Ms. Rahat Qaisrani, Senior Teacher, BPS-17 (P # 50100260) of this Institution is hereby granted 45-days Maternity Leave (Post-Confinement) with effect from 9th March, 2020 to 24th April, 2020 on full pay on medical grounds.

On the expiry of leave, the above named Government Servant is expected to resume her duty on the same station.

This is issued with the approval of competent authority.

PROF. RUBINA MAQBOOL,  
Principal.

FEDERAL GENERAL HOSPITAL

Islamabad, the 17th March, 2020

**No. PF/397/RA/ADMN/FGH.**—With the approval of competent authority, Dr. Rabia Ayub, Medical Officer (BS-17), Federal General Hospital, Ministry of National Health Services Regulation and Coordination, Islamabad has been granted 90 days (3 months) maternity leave with full pay with effect from 26th February, 2020 to 27th May, 2020.

After expiry of the leave, the officer concerned will assume her duty on 28th May, 2020 on the same post at the same station.

MUHAMMAD UMAR ASHRAF,  
Superintendent (Admn).

FEDERAL GOVERNMENT POLYCLINIC

(Postgraduate Medical Institute)

Islamabad, the 24th March, 2020

**No. FGPC 1/2033/2020.**—In pursuance of Ministry of National Health Services Regulation and Coordination Notification No. F. 2-34/2016-E-IV(FGPC) dated 25th February, 2020, the deputation period of Ms. Nadia Begum, Charge Nurse (BS-16) Health Department Government of Khyber Pakhtunkhwa, Peshawar has been extended under wedlock policy upto 30th June, 2020. This office notification of even number dated 30th January, 2020 is hereby withdrawn/cancelled.

DR. NAILA ISRAR,  
Executive Director.

Islamabad, the 24th March, 2020

**No. FGPC 1/2033/2020.**—Ms. Sandlin, Charge Nurse, (BS-16) of Federal Government Polyclinic, Islamabad was granted leave on full pay with effect from 19th February, 2020 to 9th March, 2020 (20 days). Now she has resumed duty on 10th March, 2020 after availing leave.

Islamabad, the 25th March, 2020

**No. PF. 1/3166/90.**—Dr. Farzana Hayat, Radiologist (BS-19) Federal Government Polyclinic, Islamabad was granted one month *ex-Pakistan* leave on full pay with effect from 20th February, 2020 to 19th March, 2020 *vide* Ministry of NHS, R&C Notification No. F. 1-18/2012-E-IV (FGPC) dated 7th February, 2020.

After availing above leave, she has joined her duty in this Hospital with effect from 20th March, 2020.

**No. PF. 1/5193/15.**—Dr. Khadija Iftikhar, Medical Officer (BS-17) Federal Government Polyclinic, Islamabad was granted 20 days leave on full pay with effect from 2nd March, 2020 to 21st March, 2020.

After availing above leave, she has joined her duty in this hospital with effect from 24th March, 2020 instead of 22nd March, 2020 being holidays (Sunday & Pakistan Day).

DR. FAROOQ AKHTAR,  
Deputy Executive Director.

FEDERAL SEED CERTIFICATION & REGISTRATION  
DEPARTMENT

Islamabad, the 10th March, 2020

**No. Admn. F. 5-48/2016/Vol.IV/288-291.**—The Director General, Federal Seed Certification & Registration Department, Islamabad has been pleased to accord sanction to the grant of 90 days maternity leave on full pay with effect from 5th March, 2020 to 2nd June, 2020, outside the leave account, in favour of Dr. Nasim Begum, Director (BS-19), Federal Seed Certification and Registration Department, Islamabad.

After the expiry of her leave, she will resume her duty on 3rd June, 2020 against the same post and at the same station.

AMJAD HUSSAIN SHAH,  
Deputy Director.

GENERAL HEADQUARTERS, FGEI (C/G)  
DIRECTORATE

(IGT &amp; E's Branch)

Rawalpindi, the 6th March, 2020

**No. 04/PF-123/77-FGEI (SA).**—Mrs. Naz Ghafoor, SST, FG Public School (Girls) (2nd Shift) Lalazar Rawalpindi Cantt. is hereby granted 72 days *ex-Pakistan* leave on half average pay with effect from 9th March, 2020 to 19th May, 2020 and this Dte. has no objection for proceeding her abroad (Ukraine) for private visit during this period subject to the condition that no foreign exchange will be involved on the part of Government of Pakistan on any account.

No further extension will be granted after expiry of *ex-Pakistan* leave.

ANWAR HUSSAIN, *Brig.*,  
For Director General.

Rawalpindi, the 6th March, 2020

**No. 04/PF-06/77-FGEI (NTS).**—Agha Arslan Ayaz APS, FG Degree College (Girls), Quetta Cantt is hereby granted 62 days leave on full pay with effect from 31st October, 2019 to 31st December, 2019 on private affairs.

NADEEM KHALID, *Lt. Col.*,  
For Director General.

Rawalpindi, the 29th February, 2020

**No. 04/PF-996/77-FGEI (M).**—Consequent upon his death occurred on 6th December, 2019, the family of Late Aziz Ahmed, *Ex-Principal*, FG Public School AMF Kamra Cantt is hereby granted *lump sum* payment equal to leave pay for 365 days.

Certified that 507 days leave on full pay is due at his credit.

AGHA JAVED AKBAR KHAN, *Lt. Col.*,  
For Director (SA).

Rawalpindi, the 19th February, 2020

**No. 04/PF-1193/89-FGEI (CA).**—In accordance with CNIC/credentials Syeda Vajiha Mateen, Assistant Professor (BPS-18), FG Postgraduate College for Women Wah Cantt is allowed to change her name as Syeda Vajiha Fatima.

Rawalpindi, the 21st February, 2020

**No. 04/PF-1078/88-FGEI (CA).**—Following amendment in this Dte's notification of even number dated 16th May, 2019 at para-1 is hereby made:-

**For:**

Mrs. Nighat Akmal, Assistant Professor of Botany (BPS-18) FG Postgraduate College for Women Wah Cantt is hereby granted Encashment of LPR for 67 days from 10th February, 2019 to 17th April, 2020.

**Read:**

Mrs. Nighat Akmal, Assistant Professor of Botany (BPS-18) FG Postgraduate College for Women Wah Cantt is hereby granted Encashment of LPR for 67 days from 10th February, 2020 to 17th April, 2020.

Rawalpindi, the 24th February, 2020

**No. 04/PF-814/84-FGEI (CA).**—Mrs. Sajeela Nisa, Associate Professor (BPS-19), FG Degree College for Women, Kharian Cantt is hereby granted 08 days *ex-Pakistan* leave on full pay with effect from 10th January, 2020 to 17th January, 2020.

On expiry of above leave, she was expected to join her duty at Kharian.

Rawalpindi, the 26th February, 2020

**No. 04/PF-2057/10-FGEI (CA).**—Mrs. Uzma Elahi, Lecturer in Arabic (BPS-17), FG Girls Inter College,

Abbottabad Cantt is granted maternity leave (Pre & Post Confinement) for 90 days with effect from 7th September, 2019 to 5th December, 2019.

On expiry of above leave, she was expected to join her duty at Abbottabad.

This is issued in supersession of this Dte. letter of even number dated 12th November, 2019.

**No. 04/PF-153/07-FGEI (CA).**—Syeda Hina Batool Zaidi, Lecturer in Psychology (BPS-17), FG Degree College for Women, Kharian Cantt is hereby granted 18 days leave Half Average Pay with effect from 12th November, 2019 to 29th November, 2019.

On expiry of above leave, she was expected to join her duty at Kharian.

Rawalpindi, the 28th February, 2020

**No. 04/PF-153/07-FGEI (CA).**—Syeda Hina Batool Zaidi, Lecturer in Psychology (BPS-17), FG Degree College for Women, Kharian Cantt is hereby granted 13 days Extra Ordinary leave (Without Pay) with effect from 29th January, 2020 to 13th February, 2020.

On expiry of above leave, she was expected to join her duty at Kharian.

**No. 04/PF-4/6-Gen-FGEI (CA).**—Mrs. Yasmin Anjum, Associate Professor (BPS-19), FG Degree College for Women, Multan Cantt is hereby granted 15 days leave on full pay with effect from 27th January, 2020 to 10th February, 2020 on Medical Grounds.

On expiry of above leave, she was expected to join her duty at Multan.

**No. 04/PF-2042/10-FGEI (CA).**—Mrs. Shadmeen Raza, Lecturer in Computer Science (BPS-17), Liaquat Ali Degree College for Boys Peshawar Road, Rawalpindi Cantt is granted maternity leave (Pre & Post Confinement) for 70 days with effect from 9th November, 2019 to 23rd December, 2019.

On expiry of above leave, she was expected to join her duty at Rawalpindi.

This is issued in supersession of this Dte. letter of even number dated 29th November, 2019.

**No. 04/PF-04/06-Gen-FGEI (CA).**—Having exercised her option not to avail LPR on attaining the age of superannuation on 21st September, 2020 (AN) Mrs. Farhat Naseer, Associate Professor of English (BPS-19), FG Degree College for Women, Abid Majeed Road, Rawalpindi Cantt is hereby granted encashment of LPR for 207 days from 28th February, 2020 to 21st September, 2020 in accordance with Finance Division's O.M. No.F. 1 (ii)-Imp/83 dated 18th August, 1983 & SRO (I)/2012 dated 29th August, 2012.

Certified that 207 days leave on full pay stands at her credit as verified by the Audit Office.

On expiry of encashment period, she will stand retired from Government Service and her name will be struck

off the strength of the said institution with effect from 21st September, 2020 (AN).

**No. 04/PF-134/92-FGEI (CA).**—Having exercised his option not to avail LPR on attaining the age of superannuation on 25th December, 2020 (AN) Mr. Anis Ahmed, Assistant Professor of English (BPS-18), FG Degree College, Okara Cantt is hereby granted encashment in lieu of LPR for 199 days from 10th June, 2020 to 25th December, 2020 in accordance with Finance Division's O.M. No.F.1(ii)-Imp/83 dated 18th August, 1983 & SRO (I)/2012 dated 29th August, 2012.

Certified that 199 days leave on full pay stands at his credit as verified by the Audit Office.

On expiry of encashment period, he will stand retired from Government Service and his name will be struck off the strength of the said institution with effect from 25th December, 2020 (AN).

**No. 04/PF-863/85-FGEI (CA).**—Having exercised her option not to avail LPR on attaining the age of superannuation on 28th February, 2021 (AN) Ms. Shehla Nargis, Associate Professor of English (BPS-19), FG Degree College for Women, Kohat Cantt is hereby granted encashment of LPR for 365 days from 31st March, 2020 to 28th February, 2021 in accordance with Finance Division's O.M. No.F.1(ii)-Imp/83 dated 18th August, 1983 & SRO (I)/2012 dated 29th August, 2012.

Certified that 506 days leave on full pay stands at her credit as verified by the Audit Office.

On expiry of encashment period, she will stand retired from Government Service and her name will be struck off the strength of the said institution with effect from 28th February, 2021 (AN).

**No. 04/PF-1029/87-FGEI (CA).**—Having exercised her option not to avail LPR on attaining the age of superannuation on 3rd January, 2021 (AN) Ms. Nazrin Zubair, Assistant Professor of Urdu (BPS-18), FG Degree College for Women, Kohat Cantt is hereby granted encashment of LPR for 174 days from 14th August, 2020 to 3rd January, 2021 in accordance with Finance Division's O.M. No.F.1(ii)-Imp/83 dated 18th August, 1983 & SRO (I)/2012 dated 29th August, 2012.

Certified that 174 days leave on full pay stands at her credit as verified by the Audit Office.

On expiry of encashment period, she will stand retired from Government Service and her name will be struck off the strength of the said institution with effect from 3rd January, 2021 (AN).

**No. 04/PF-1503/07-FGEI (CA).**—Following Staff of FG Degree College for Women, Peshawar Cantt is hereby granted Extra Ordinary Leave (without pay):-

Ser	Name & Designation	Period (Days)
a.	Ms. Majida Khanum, Assistant Professor	14 days
b.	Ms. Irum Shirin, Lecturer	04 days
c.	Ms. Gulshan Amna, Lecturer	04 days



On expiry of above leave, they was expected to join their duties at Peshawar.

Rawalpindi, the 5th March, 2020

**No. 04/PF-4/6-Gen-FGEI (CA).**—Mrs. Nabila Shaheen, Lecturer in Statistics (BPS-18), FG Postgraduate College for Women, Kashmir Road, Rawalpindi Cantt is hereby granted 25 days ex-Pakistan leave on full pay with effect from 15th March, 2020 to 8th April, 2020.

On expiry of above leave, she is expected to join her duty at Rawalpindi.

**No. 04/PF-1817/08-FGEI (CA).**—Consequent upon her promotion from Lecturer (BPS-17) to Assistant Professor (BPS-18) with effect from 27th November, 2018 made *vide* this Directorate's Notification No. 0409/3/77-FGEI (CA) dated 26th December, 2018 & No.0409/Tfr/77-FGEI (CPM) dated 15th January, 2020, Ms. Farzana Habib, FG Degree College, Okara Cantt has take over to the post of Assistant Professor of Botany in FG Degree College, Okara Cantt with effect from 26th December, 2018.

She will be on probation for a period of one year with effect from 26th December, 2018.

FASIH ULLAH, *Lt. Col.*,  
For Director General.

Rawalpindi, the 29th February, 2020

**No. 04/PF-548/77-FGEI (M).**—Mr. Ghulam Shabbir, TGT (BPS-16) FG Public School (Boys) Sher Shah Road, Multan Cantt is hereby granted leave on full pay for 24 days from 28th November, 2019 to 21st December, 2019 on medical grounds.

**No. 04/PF-822/77-FGEI (M).**—Mr. Asif Hussain, TGT (BPS-16) FG Public School (Boys) (2nd Shift) Nai Chawni Rawalpindi is hereby granted leave on full pay for 12 days from 10th February, 2020 to 21st February, 2020 on private affairs..

Rawalpindi, the 2nd March, 2020

**No. 04/PF-929/77-FGEI (SA).**—Mrs. Zahida Khurshaid, TGT, FG Junior Public School (2nd Shift) Abid Majeed Road Rawalpindi is hereby granted 45 days Post-confinement materniy leave on full pay with effect from 18th December, 2019 to 31st January, 2020.

**No. 04/PF-862/77-FGEI (SA).**—Mrs. Afshan, TGT, FG Public School Hyderabad Cantt is hereby granted 28 days extension in leave on full pay with effect from 1st February, 2020 to 28th February, 2020 on private affairs.

**No. 04/PF-355/77-FGEI (SA).**—Miss Shumaila Noreen, SST (deputationist), FG Public School No. 1 (Girls) Bahawalpur Cantt is hereby granted 26 days leave on half average pay with effect from 17th February, 2020 to 13th March, 2020 on private affairs.

On expiry of above leave, she is expected to resume her duty in the same school at Bahawalpur Cantt.

Rawalpindi, the 3rd March, 2020

**No. 04/PF-2237/77-FGEI (SA).**—Mrs. Tallet Chaudhery, TGT, FG Public School Okara Cantt. is hereby granted 42 days ex-Pakistan leave on full pay with effect from 7th March, 2020 to 17th April, 2020 and this Dte. has no objection for proceeding her abroad (Canada) for private visit during this period, subject to the condition that no foreign exchange will be involved on the part of Government of Pakistan on any account.

No further extension will be granted after expiry of ex-Pakistan leave.

Rawalpindi, the 4th March, 2020

**No. 04/PF-510/77-FGEI (M).**—Mr. Muhammad Zahid, Principal, FG Sapper Public School No. 2 (Boys) Risalpur Cantt is hereby granted leave on full pay for 16 days from 10th February, 2020 to 25th February, 2020 on private affairs.

**No. 04/PF-152/77-FGEI (M).**—Consequent upon his death occurred on 18th February, 2020 the name of Mr. Imtiaz Ahmed, SST (BPS-17), FG Public School (2nd Shift) CMT & SD Golra Rawalpindi is hereby struck off the strength of the said school with effect from the same date.

**No. 04/PF-776/77-FGEI (M).**—Mr. Inayat-ur-Rehman, Principal (BPS-19) FG Public School No. 1 (Boys) T/C Bahawalpur Cantt is hereby granted leave on full pay for 05 days from 17th February, 2020 to 21st February, 2020 on private affairs.

This Dte notification of even number dated 25th February, 2020 is hereby cancelled.

Rawalpindi, the 5th March, 2020

**No. 04/PF-211/77-FGEI (SA).**—*Ex-post facto* sanction is hereby granted for leave on full pay with effect from 1st April, 2019 to 9th May, 2019 (39 days) on private affairs in respect of Mrs. Nighat Nadeem, *Ex-DM*, FG Public School (Girls) Daryabad Rawalpindi Cantt.

This issues with the approval of competent authority.

**No. 04/PF-742/77-FGEI (SA).**—Mrs. Aneela, Computer Instructor, FG Public School No. 3 (Girls) Multan Cantt is hereby granted 45 days post-confinement maternity leave on full pay with effect from 30th November, 2019 to 13th January, 2020.

Rawalpindi, the 9th March, 2020

**No. 04/PF-218/77-FGEI (SA).**—Consequent upon resignation from Government Service in respect of Mrs. Asifa Javed, SST (BPS-17), FG Public School (Girls) 2nd Shift Lalazar Rawalpindi Cantt is hereby accepted with effect from 1st November, 2019.

This is issued with the approval of Ministry of Defence *vide* their U.O. No. 139/D-22/2020 dated 3rd March, 2020.

Rawalpindi, the 10th March, 2020

**No. 04/PF-172/77-FGEI (SA).**—Mrs. Mehnaz Akhtar, TGT, FG Junior Public School No. 1 Risalpur Cantt. is hereby granted 21 days ex-Pakistan leave on full pay with effect from 24th March, 2020 to 13th April, 2020 and this Dte. has no objection for proceeding her abroad

(Saudi Arabia) for performance of Umrah during this period, subject to the condition that no foreign exchange will be involved on the part of Government of Pakistan on any account.

No further extension will be granted after expiry of ex-Pakistan leave.

ALI RAZA SHAH, *Major,*  
For Director General.

GEOLOGICAL SURVEY OF PAKISTAN

Quetta, the 1st November, 2019

**No. Estt-I-755/PF.**—Ms. Maria Yaqub, Assistant Director (BPS-17), Geological Survey of Pakistan, Lahore is granted 90 days leave from 11th June, 2019 to 8th September, 2019, under Rules 13 of Revised Leave Rules, 1980 as under:-

- i. 45 days Maternity Leave on full pay from 11th June, 2019 to 25th July, 2019 after confinement.
- ii. 45 days leave on full pay from 26th July, 2019 to 8th September, 2019.

2. On expiry of the leave, she has assumed her duty on the same post and station.

Quetta, the 6th November, 2019

**No. Estt-I-829/PF.**—Mr. Mukhtiar Ghani, Assistant Geophysicist, Geological Survey of Pakistan, Quetta is granted 10 days leave on full pay from 16th October, 2019 to 25th October, 2019 (with permission to leave the station) subject to title.

On expiry of the leave, the officer will assume his duty on the same post and station.

**No. Estt-I-874/PF.**—Mr. Manoj Kumar, Assistant Director, Geological Survey of Pakistan, Quetta is granted 12 days leave on full pay from 28th October, 2019 to 8th November, 2019 with permission to leave the station (subject to title).

On expiry of the leave, the officer will assumed his duty on the same post and station.

**No. Estt-I-615/PF.**—Mr. Waheed Akhtar, Deputy Director, Geological Survey of Pakistan, Quetta is granted 12 days leave on full pay from 21st October, 2019 to 1st November, 2019 (with permission to leave the station) on 19th October, 2019 subject to title.

On expiry of the leave, the officer will assume his duty on the same post and station.

Quetta, the 12th November, 2019

**No. Estt-I-570/PF.**—Syed Ali Abbas, Geophysicist, Geological Survey of Pakistan, Quetta is granted 30 days leave on full pay from 11th November, 2019 to 10th December, 2019 (with permission to leave the station) subject to title.

On expiry of the leave, the officer will assume his duty on the same post and station.

**No. Estt-I-847/PF.**—Mr. Shahzaib Murtaza, Assistant Director, Geological Survey of Pakistan, Quetta is granted 15 days R&R leave on full pay from 4th November, 2019 to 18th November, 2019 (with permission to leave the station on 1st November, 2019 at 1:00 P.M) subject to title.

On expiry of the leave, the officer will assumed his duty on the same post and station.

Quetta, the 14th November, 2019

**No. Estt-I-820/PF.**—Mr. Abid Hussain Farooqi, Electronic Officer, Geological Survey of Pakistan, Quetta is granted 30 days leave on full pay from 11th November, 2019 to 10th December, 2019 with permission to leave the station on 8th November, 2019 (subject to title).

On expiry of the leave, the officer will assume his duty on the same post and station.

Quetta, the 15th November, 2019

**No. Estt-I-817/PF.**—The Secretary, Ministry of Energy (Petroleum Division), Islamabad being the competent authority has been pleased to accept the resignation tendered by Mr. Zeeshan Haider, Drilling Engineer (BPS-17), Geological Survey of Pakistan, Quetta with effect from 14th March, 2019 *vide* Ministry of Energy (Petroleum Division) Letter No. GSP-3(2)/2016 dated 19th July, 2019.

The name of Mr. Zeeshan Haider has been stuck off from the strength of Geological Survey of Pakistan with effect from 14th March, 2019.

Quetta, the 18th November, 2019

**No. Estt-I-589/PF.**—Mr. Muhammad Atif, Geophysicist, Geological Survey of Pakistan, Quetta is granted 15 days leave on full pay from 30th October, 2019 to 13th November, 2019 with permission to leave the station (subject to title).

On expiry of the leave, the officer has assumed his duty on the same post and station.

ZAHID HUSSAIN KHAN,  
Deputy Director (Admn).

Quetta, the 27th November, 2019

**No. Estt-I-615/PF.**—In pursuance of Ministry of Energy (Petroleum Division), Islamabad Letter No. GSP-2 (109) / 2009-Pt dated 20th November, 2019, the competent authority *i.e.* Secretary, Ministry of Energy (Petroleum Division) has been pleased to grant extension in current charge to Mr. Waheed Akhtar, Deputy Director (BPS-18), Geological Survey of Pakistan, Quetta to the post of Director (BPS-19), Geological Survey of Pakistan, Quetta for another period of 90 days with effect from 1st October, 2019, or till the availability of regular incumbent whichever is earlier. The officer will be entitled to draw special pay as admissible under rules.

**No. Estt-I-615/PF.**—In pursuance of Ministry of Energy (Petroleum Division), Islamabad Letter No. GSP-2 (109) / 2009-Pt dated 20th November, 2019, the competent authority *i.e.* Secretary, Ministry of Energy (Petroleum Division) has been pleased to grant extension in current

charge to Mr. Muhammad Saeed, Superintending Geophysicist (BPS-19), Geological Survey of Pakistan, Quetta to the post of Chief Geophysicist (BPS-20), Geological Survey of Pakistan, Quetta for another period of 90 days with effect from 1st October, 2019, or till the availability of regular incumbent whichever is earlier. The officer will be entitled to draw special pay as admissible under rules.

Quetta, the 29th November, 2019

**No. Estt-1-619/PF.**—In pursuance of Ministry of Energy (Petroleum Division), Islamabad Notification No. GSP-2 (17)/2012 dated 20th November, 2019, Mr. Khalid Khan, is appointed as Director (BPS-19) in the Geological Survey of Pakistan. The officer has assumed the charge of the post of Director (BPS-19) on 31st July, 2019 at GSP, Lahore. He has been transferred from GSP, Lahore to GSP, Islamabad *vide* Office Order of even number dated 30th October, 2019.

He will be on probation for a period of one year in terms of Rule-21 of the Civil Servants (Appointment, Promotion and Transfer) Rules, 1973.

The officer will draw his salary under the Head of Accounts Part-I, GSP, Lahore.

WASEEM UD DIN,  
Superintendent.

JINNAH POSTGRADUATE MEDICAL CENTRE

Karachi, the 6th March, 2020

**No. PF. 2.94/LN/Admn-1/JPMC.**—Mst. Lubna Nadeem D/o. Muhammad Yaqoob, Charge Nurse of this Centre has been granted LFP for 03 days with effect from 17th February, 2020 to 19th February, 2020, combined with EOL (without pay and allowances) for 04 days with effect from 20th February, 2020 to 23rd February, 2020, subject to title.

She has resumed her duty on 24th February, 2020.

**No. PF. 2-396/S/Admn-1/JPMC.**—Mst. Shabana D/o. Inayatullah, Charge Nurse of this Centre has been granted LFP for 33 days with effect from 15th January, 2020 to 16th February, 2020, subject to title.

She has resumed her duty on 17th February, 2020.

**No. PF. 2-393/ZG/Admn-1/JPMC.**—Mst. Zubaida Ghori D/o. Ishaq Sajid Ghori, Charge Nurse of this Centre has been granted LFP for 03 days with effect from 17th February, 2020 to 19th February, 2020, on medical grounds subject to title.

She has resumed her duty on 20th February, 2020.

**No. PF. 2-EOL/2020/Admn-1/JPMC.**—The unauthorized absence from duty in respect of following Charge Nurses of this Centre has been treated as EOL (without pay and allowances) on the dates noted against each:-

S#	Name	Absent Period	Resumed Duty
1.	Mr. Noreen Moinddin	For 02 days with effect from 26th January, 2020 to 27th January, 2020	28th January, 2020
2.	Mr. Ahtesham Shahazad	For 03 days with effect from 29th January, 2020 to 31st January, 2020	1st February, 2020
3.	Mst. Samina Aster	For 02 days with effect from 1st January, 2020 to 2nd January, 2020	3rd January, 2020
4.	Mst. Surriya Nusrat	For 03 days with effect from 24th January, 2020 to 26th January, 2020	27th January, 2020
5.	Mst. Amna Bibi	For 03 days with effect from 11th January, 2020 to 13th January, 2020	14th January, 2020
6.	Mst. Kiran Anjum	For 04 days <i>i.e.</i> 16th January, 2020, 22nd January, 2020 to 23rd January, 2020 and 29th January, 2020	17th January, 2020, 24th January, 2020 and 30th January, 2020

S#	Name	Absent Period	Resumed Duty
7.	Mst. Razia Inayat	For 02 days with effect from 11th January, 2020 to 13th January, 2020	14th January, 2020
8.	Mst. Saima George	For 02 days with effect from 23rd January, 2020 to 24th January, 2020	25th January, 2020
9.	Mr. Mehboob Aziz	For 02 days <i>i.e.</i> 2nd January, 2020 and 7th January, 2020	3rd January, 2020 and 8th January, 2020
10.	Mst. Rehana Khizan	For 03 days <i>i.e.</i> 5th January, 2020 and 9th January, 2020 to 10th January, 2020	6th January, 2020 and 11th January, 2020
11.	Mr. Redad Gul	For 02 days <i>i.e.</i> with effect from 9th January, 2020 and 11th January, 2020	10th January, 2020 and 12th January, 2020
12.	Mst. Fareeda Begum	For 01 day <i>i.e.</i> 25th January, 2020	26th January, 2020
13.	Mst. Kafeela Khan	For 02 days <i>i.e.</i> 14th January, 2020 and 21st January, 2020	15th January, 2020 and 22nd January, 2020
14.	Mst. Rukhsana Naz	For 01 day <i>i.e.</i> 5th January, 2020	6th January, 2020
15.	Mr. Hammad Ahmed	For 02 days <i>i.e.</i> 27th January, 2020 and 31st January, 2020	28th January, 2020 and 1st February, 2020
16.	Mst. Shazia Parveen	For 02 days <i>i.e.</i> 17th January, 2020 and 24th January, 2020	18th January, 2020 and 25th January, 2020
17.	Mr. Amjad Ali	For 02 days with effect from 14th January, 2020 to 15th January, 2020	16th January, 2020
18.	Mr. Khuram Saghir	For 02 days <i>i.e.</i> 25th January, 2020 and 28th January, 2020	26th January, 2020 and 29th January, 2020
19.	Mst. Asiya Noureen	For 02 days <i>i.e.</i> 11th January, 2020 and 18th January, 2020	12th January, 2020 and 19th January, 2020
20.	Mr. M. Tanveer Nazeer	For 01 day <i>i.e.</i> 27th January, 2020	28th January, 2020
21.	Mst. Lubna Nadeem	For 03 days with effect from 4th January, 2020 to 5th January, 2020 and 27th January, 2020	6th January, 2020 and 28th January, 2020
22.	Mst. Sidra Yasmin	For 02 days <i>i.e.</i> 20th January, 2020 and 22nd January, 2020	21st January, 2020 and 23rd January, 2020

Karachi, the 10th March, 2020

**No. PF. 2.128/RI/Admn-1/JPMC.**—Mst. Razia Inayat D/o. Inayat, Charge Nurse (BPS-16) of this Centre has been granted EOL (without pay and allowances) for 06 days with effect from 23rd February, 2020 to 28th February, 2020.

She has resumed her duty on 29th February, 2020.

**No. PF. 2-343/ZG/Admn-1/JPMC.**—Mst. Zara Gul D/o. Muhammad Safdar Awan, Charge Nurse of this Centre has been granted LFP for 48 days with effect from 7th January, 2020 to 23rd February, 2020, subject to title.

She has resumed her duty on 24th February, 2020.

**No. PF. 2-437/SA/Admn-1/JPMC.**—Mr. Shahid Ahmed S/o. Shabbir Ahmed, Charge Nurse of this Centre has been granted LFP from 11th December, 2019 to 23rd February, 2020, subject to title.

She has resumed her duty on 24th February, 2020.

DR. SEEMIN JAMALI *T*,  
Executive Director.

---

MODEL CUSTOMS COLLECTORATE OF PREVENTIVE

Karachi, the 3rd March, 2020

**No. 04/2020-Estt (P).**—In pursuance of Board's Notification No. 0328-C-III/2020 dated 24th February, 2020, Mr. Sultan Mahmood has assumed the charge of Superintendent Preventive Service (BS-16), Model Customs Collectorate of Preventive, Karachi with effect from 27th February, 2020.

NAYAB AZHAR,  
Assistant Collector Establishment.

---

NATIONAL INSTITUTE OF REHABILITATION MEDICINE

Islamabad, the 27th February, 2020

**No. F. 114(FA)/PC-NIRM.**—Mrs. Gulshan Afroz, Psychologist (BS-17) of this Institute is hereby granted 07 days leave with full pay on medical grounds from 1st June, 2019 to 1st July, 2019.

After expiry of leave she has assumed his duties on the same post and station.

Islamabad, the 3rd March, 2020

**No. F. 16(RN)/PC-NIRM.**—Mrs. Rehana Noor Psychologist (BS-17) of this Institute is hereby granted 29 days leave with full pay from 3rd March, 2020 to 31st March, 2020.

After expiry of leave she is expected to join her duties on the same post and station.

Islamabad, the 4th March, 2020

**No. F. 3-16/99-NIRM.**—Dr. Ghulam Murtaza Bodla, Psychologist (BS-18) of this Institute is hereby granted 90 days leave with full pay from 10th March, 2020 to 7th June, 2020.

After expiry of leave he is expected to assume his duties on the same post and station.

**No. F. 2-144/2004-NIRM.**—Mrs. Rebecca Akram Charge Nurse (BS-17) of this Institute is hereby granted 60 days leave with full pay from 7th February, 2020 to 6th April, 2020.

After expiry of leave she is expected to assume her duties on the same post and station.

Islamabad, the 11th March, 2020

**No. F. 3-25/96-NIRM.**—Dr. Adnan Riaz, Medical Officer (BS-18) of this Institute is hereby granted 16 days leave with full pay from 16th March, 2020 to 31st March, 2020.

After expiry of leave he is expected to assume his duties on the same post and station.

**No. F. 31(RS)/PC-NIRM.**—Dr. Rubina Somroo, Medical Officer (BS-17) of this Institute is hereby granted 10 days leave with full pay from 9th March, 2020 to 18th March, 2020.

After expiry of leave she is expected to assume her duties on the same post and station.

**No. F. 2-216/10-NIRM.**—Mrs. Rahat Akbar Staff Nurse (BS-16) of this Institute is hereby granted 15 days leave with full pay from 6th April, 2020 to 20th April, 2020.

After expiry of leave she is expected to assume her duties on the same post and station.

M. B. TAHIR,  
Assistant Director (A).

---

NATIONAL TRUST FOR THE DISABLED

Islamabad, the 11th March, 2020

**No. F. 2-2/2003 (ZH)-NTD.**—Mr. Zafar Hayat, Assistant Accounts Officer (BS-16), National Trust for the Disabled, Ministry of Human Rights, is granted ten days L.F.P. with effect from 11th March, 2020 to 20th March, 2020 under Revised Leave Rules, 1980.

IJAZ AHMAD,  
Assistant Director, NTD.

---

NATIONAL VOCATIONAL AND TECHNICAL TRAINING COMMISSION

Islamabad, the 13th March, 2020

**No. F. 1-367/2019-Admn/992.**—This Commission's notification of even number dated 26th February, 2020 regarding thirteen (13) days ex-Pakistan leave with effect from 9th to 21st March, 2020, of Mr. Muhammad Saleem Afzal, a BS-19 officer of Pakistan Administrative Service (PAS), presently posted in NAVTTC Regional Office, Lahore on deputation basis to perform Umrah is hereby cancelled/ withdrawn.

This issues with the approval of competent authority.

Islamabad, the 26th March, 2020

**No. F. 3-141/2013-Admn/31.**—With the approval of Executive Director, NAVTTC, Mr. Muhammad Asghar Gondal, Director (Admn) NAVTTC HQs, Islamabad, is hereby assigned the current charge of the vacant post of Director General (A&F), in addition to his own duties, for a period of three months with effect from 16th March, 2020 or till the joining of regular incumbent whichever is earlier.

MUHAMMAD ISHAQ,  
Deputy Director (HRM).

Islamabad, the 11th March, 2020

**No. F. 1-384/2020-Admn/1149.**—In pursuance of NAVTTC's Letter No. 3-48/2019-Admn/915 dated 21st January, 2020 and Technical Education & Vocational Training Authority, Government of Punjab Rawalpindi's Order No. TEVTA/DM/RWP/Admin/263-67 dated 17th February, 2020, Mst. Saima Gill, Principal (BS-17), an employee of Punjab TEVTA, has assumed charge of the post of Assistant Director (BS-17) in NAVTTC Regional Office, Karachi, with effect from 21st February, 2020, on standard terms & conditions of deputation.

MUHAMMAD NADEEM,  
Assistant Director (Admn-I).

OFFICE OF THE CHIEF COMMISSIONER INLAND  
REVENUE

[REGIONAL TAX OFFICE-III]

Karachi, the 11th March, 2020

**No. SO-VI/CCIR/RTO-III/Khi/2019-20/5785.**—In exercise of the powers conferred under sub-section (1) of Section 209 of the Income Tax Ordinance, 2001, sub-section (2B) of Section 30 of the Sales Tax Act, 1990 and sub-section (1AB) of Section 29 of the Federal Excise Act, 2005, the Chief Commissioner Inland Revenue, RTO-III, Karachi is pleased to assign/transfer the jurisdiction of M/s. Scaptox, 3290154-2 and M/s. Rewterz Information Security, NTN 7552951-7 from Zone-III, RTO-III, Karachi to Zone-I, RTO-III, Karachi with immediate effect.

This Order shall take effect immediately till further orders.

DR. AMIR TALPUR,  
Chief Commissioner.

OFFICE OF THE COMMISSIONER INLAND REVENUE  
ZONE-IV

[LARGE TAXPAYERS UNIT-II]

Karachi, the 10th March, 2020

*JURISDICTION/ADDENDUM*

**No. CIR/ZONE-IV/Jurisdiction/LTU-II/2019-20/1575.**—In exercise of the powers conferred under sub-section (1) of Section 210 of the Income Tax Ordinance, 2001 (XILIX) of 2001 sub section (1) of Section 30 and Section 31 of

the Sales Tax Act, 1990 sub section (1) of Section 29 of the Federal Excise Act, 2005, the undersigned has been pleased to assign the case mentioned in Column No. 2 of the table below to the Deputy Commissioner-IR, Unit-01 Zone-IV, LTU-II, Karachi in Column-03.

2. This notification shall take effect immediately.

TABLE

COLUMN-1	COLUMN-2	COLUMN-3
1	M/s. GAR Pakistan (Pvt) Limited NTN:5030604	Deputy Commissioner Inland Revenue, Unit-01, Zone-IV, LTU-II, Karachi

SAHIBZADA ABDUL MATEEN,  
Commissioner-IR.

OFFICE OF THE CHIEF COLLECTOR CUSTOMS  
APPRAISEMENT AND FACILITATION-CENTRAL

Lahore, the 2nd March, 2020

**No. 01-CC(Central)-App-04/2019/Pt.I/406.**—Mr. Aman Ullah, Inspector (BS-16), Model Customs Collectorate, Sialkot is granted 21-days ex-Pakistan leave on full pay from the date of availing to visit Saudi Arabia for performance of Umrah.

2. The Chief Collector Customs-Appraisalment & Facilitation (Central), Federal Board of Revenue, Government of Pakistan has no objection to the proceeding abroad of the officer during his leave period.

BEELAM RAMZAN,  
Additional Collector.

OFFICE OF THE INSPECTOR GENERAL FRONTIER  
CORPS BALOCHISTAN

Turbat, the 28th February, 2020

**No.132-37/Prom/31/SE-2-Promotion.**—Following Promotions were ordered in Frontier Corps Balochistan (South), Turbat with effect from the dates noted against each:-

*TO BE SUBEDAR MAJOR ON PROBATION FOR ONE YEAR*

- No. 13560 Subedar (General Duty) Akhtar Zaman, Pathan of 113 Wing Mekran Scouts with effect from 18th December, 2019 vice No. 16936 Subedar Fakhar Ud Din proceeded on retirement with effect from 17th December, 2019.
- No. 11721 Subedar (General Duty) Iqrar Ullah, Pathan of 165 Wing Mekran Scouts with effect from 9th September, 2019 on an existing vacancy.
- No. 28959 Subedar (General Duty) Akbar Khan, Pathan of 166 Wing Panjgur Rifles with effect from 9th December, 2019 on an existing vacancy.

*TO BE SUBEDAR ON PROBATION FOR ONE YEAR*

4. No. 4921 Naib Subedar (General Duty) Sher Zaman, Punjabi of 147 Wing Dasht Scouts with effect from 9th September, 2019 *vice* No. 14278 Subedar Shah Ahmed Ali posted to 165 Wing Mekran Scouts from the same date.
5. No. 5401 Naib Subedar (Signal) Zafar Iqbal, Punjabi of 63 Wing Mekran Scouts with effect from 24th November, 2019 (on completion of two years rank service) on an existing vacancy.

*TO BE NAIB SUBEDAR ON PROBATION FOR ONE YEAR*

6. No. 40922 Havildar (Mechanical Transport) Umar Bayaz Khan, Pathan of 142 Special Operation Wing with effect from 31st October, 2019 (on passing of junior leadership course) *vice* Naib Subedar Akhtar Raheem proceeded on retirement with effect from 4th July, 2019.
7. No. 5641 Havildar (General Duty) Faiz Muhammad, Punjabi of 128 Wing Awaran Militia with effect from 10th December, 2019 *vice* No. 17644 Naib Subedar Abid Hussain promoted as Subedar from the same date.
8. No. 14095 Havildar (Mortar) Muhammad Yousaf Pathan of 125 Wing Dasht Scouts with effect from 31st October, 2019 *vice* No. 4845 Subedar Abdul Latif proceeded on retirement from the same date.
9. No. 40083 Havildar (General Duty) Ghulam Mustafa, Punjabi of 127 Wing Panjgur Rifles with effect from 9th December, 2019 *vice* No. 30025 Naib Subedar Muhammad Sohail Ayaz promoted as Subedar from the same date.

AAMIR ZAFAR, *Lieutenant Colonel,*  
For Inspector General.

OFFICE OF THE INSPECTOR GENERAL FRONTIER  
CORPS KHYBER PAKHTUNKHWA

Peshawar, the 22nd February, 2020

**No. 34/Prom/33/X/RW.**—The following promotions are ordered:-

*TO BE SUBEDAR MAJOR ON PROBATION OF SIX MONTHS*

1. Number 502940 Subedar Rafiq Muhammad Yousafzai of 101 Wing Khyber Rifles with effect from 27th December, 2019 (forenoon) *vice* number 502402 Subedar Major Sher Abbas Khan proceeded on pension with effect from 26th December, 2019 (afternoon).

*TO BE SUBEDAR ON PROBATION OF SIX MONTHS*

2. Number 103780 Naib Subedar Muhammad Akram, Orakzai (75 Recoiless Rifles Establishment) of Orakzai Scouts with effect from 1st January, 2018 (forenoon) *vice* Number 102708 Subedar

Jalat Khan, Bhattani (Pioneer Establishment) promoted Subedar Major with effect from 1st January, 2018 (forenoon).

3. Number 1200576 Naib Subedar Ziarat Khan, Tarkani of 213 Wing Swat Scouts (Tribal District) with effect from 1st April, 2019 (forenoon) on creation of vacancy in Battalion System with effect from 1st April, 2019.

*TO BE NAIB SUBEDAR ON PROBATION OF SIX MONTHS*

4. Number 104969 Havildar Umar Daraz, Mohmand of 165 Wing Mahsud Scouts (Settle District) with effect from 9th November, 2018 (forenoon) from the date of qualification in existing vacancy of new raised 165 Wing Mahsud Scouts with effect from 1st February, 2017.
5. Number 105058 Havildar Muhammad Jan, Mohmand of 165 Wing Mahsud Scouts (Settle District) with effect from 25th March, 2019 (forenoon) from the date of qualification in existing vacancy of new raised 165 Wing Mahsud Scouts with effect from 1st February, 2017.
6. Number 803043 Havildar Rahim Said, Tarkani of 165 Wing Mahsud Scouts (Tibal District) with effect from 9th November, 2018 (forenoon) from the date of qualification in existing vacancy of new raised 165 Wing Mahsud Scouts with effect from 1st February, 2017.
7. Number 405076 Havildar Muhammad Nasir Ullah, Chitrali of 165 Wing Mahsud Scouts (Settle District) with effect from 25th March, 2019 (forenoon) from the date of qualification in existing vacancy of new raised 165 Wing Mahsud Scouts with effect from 1st February, 2017.
8. Number 1201340 Havildar Rehan Ali, Turi of 164 Wing Mahsud Scouts (Tribal District) with effect from 6th March, 2019 (forenoon) against higher rank of Subedar *vice* Number 702227 Subedar Matloob Hussain, Orakzai promoted Subedar Major with effect from 26th September, 2018.
9. Number 1201354 Havildar Mudassar Hussain, Khattak of Swat Scouts with effect from 26th December, 2019 (forenoon) after completion of 9 months deferment period *vice* Number 103327 Naib Subedar Riaz Ahmed, Khattak proceeded on retiring pension with effect from 14th March, 2019.
10. Number 1201341 Havildar Muhammad Ali, Turi of 211 Wing Swat Scouts (Tribal District) with effect from 1st April, 2019 (forenoon) on creation of vacancy in Battalion System with effect from 1st April, 2019.
11. Number 405351 Havildar Fida Hussain, Chitrali of Swat Scouts with effect from 27th January, 2020 (forenoon) after completion of 6 months deferment period *vice* Number 404665 Naib Subedar Afzal Murad Khan, Chitrali promoted Subedar with effect from 1st March, 2019.

12. Number 103751 Havildar Murad Shah, Khattak of 103 Wing Khyber Rifles (Settle District) with effect from 9th October, 2019 (forenoon) from the date of qualification *vice* on creation of vacancy in Battalion System with effect from 1st April, 2019.

Peshawar, the 26th February, 2020

**No. 25/Cfm/OS SOG/X/RW.**—On completion of probationary period of six months, under mentioned Junior Commissioned officers are confirmed in their present rank from the date as noted against each:-

1. Number 202860 Naib Subedar Khalif Khan, Afridi of Orakzai Scouts Special Operation Group with effect from 31st March, 2016.
2. Number 104492 Naib Subedar Badshah Khan, Afridi of Dir Scouts with effect from 31st August, 2019.
3. Number 505926 Naib Subedar Shamim Ullah, Khattak of Dir Scouts with effect from 31st August, 2019.
4. Number 505272 Naib Subedar Afsar Khan, Wazir of Dir Scouts with effect from 31st August, 2019.
5. Number 902419 Naib Subedar Zain Ul Munir, Khattak (Pioneer Establishment) of Dir Scouts with effect from 31st August, 2019.

MUHAMMAD IMRAN, *Lt. Col.*,  
Officer Incharge Records.

Dera Ismail Khan, the 21st February, 2020

**No. 30/1/GN Prom/X/RW.**—The following promotions are ordered from the date as noted against each:-

*TO BE SUBEDAR MAJOR ON PROBATIONARY PERIOD OF SIX MONTHS*

1. Number 102962 Subedar Salar Muhammad, Ranizai of Kurram Militia with effect from 7th October, 2019 (forenoon) *vice* Number 102814 Subedar Major Parvez Khan, Ranizai proceeded on retiring pension with effect from 6th October, 2019 (afternoon).
2. Number 602049 Subedar Khan Zamir, Bhattani (Mechanical Transport Establishment) of Thall Scouts with effect from 17th August, 2019 (forenoon) *vice* Number 601626 Subedar Major Sanab Gul, Yousafzai proceeded on Medical Board pension with effect from 16th August, 2019 (afternoon).
3. Number 1001430 Subedar Gohar Khan, Mohmand of Thall Scouts with effect from 29th October, 2019 (forenoon) *vice* Number 1101949 Subedar Major Rizwan Ullah proceeded on retiring pension with effect from 28th October, 2019 (afternoon).

*TO BE SUBEDAR ON PROBATIONARY PERIOD OF SIX MONTHS*

4. Number 1200325 Naib Subedar Fazal Alim, Ranizai of Kurram Militia with effect from 7th October, 2019 (forenoon) *vice* Number 102992 Subedar Salar Muhammad Ranizai promoted Subedar Major from the same date.
5. Number 1200886 Naib Subedar Kamin Khan, Ranizai (Mechanical Transport Establishment) of Kurram Militia with effect from 18th June, 2019 (forenoon) (from the date of confirmation as Naib Subedar) *vice* Number 103081 Subedar Muhammad Roshan, Khattak proceeded on retiring pension with effect from 17th July, 2018 (afternoon).
6. Number 1200357 Naib Subedar Shah Rasool Khan, Ranizai of Kurram Militia with effect from 27th February, 2020 (forenoon) *vice* Number 302303 Subedar Fazal Alim Bacha, Ranizai proceeded on retiring pension with effect from 26th February, 2020 (afternoon).
7. Number 103656 Naib Subedar Muhammad Ishaq, Khattak of Kurram Militia with effect from 8th July, 2019 (forenoon) *vice* Number 102906 Subedar Shafi Ur Rehman, Khattak proceeded on retiring pension with effect from 7th July, 2019 (afternoon).
8. Number 103660 Naib Subedar Ihsan Ullah, Khattak of Kurram Militia with effect from 6th January, 2020 (forenoon) *vice* Number 102957 Subedar Nazif Ullah, Khattak proceeded on retiring pension with effect from 5th January, 2020 (afternoon).
9. Number 103700 Naib Subedar Jehangir Khan, Khattak of Kurram Militia granted unpaid rank of Subedar upto 14th April, 2020 (afternoon) and paid rank of Subedar from 15th April, 2020 (forenoon) *vice* Number 103014 Subedar Amin Ur Rehman, Khattak proceeding on retiring pension with effect from 14th April, 2020 (afternoon).
10. Number 103853 Naib Subedar Arif, Yousafzai of Kurram Militia with effect from 9th July, 2019 (forenoon) *vice* Number 103119 Subedar Feroz Shah, Yousafzai proceeded on retiring pension with effect from 8th July, 2019 (afternoon).
11. Number 103879 Naib Subedar Shah Jehan, Afridi of Kurram Militia granted unpaid rank of Subedar upto 20th March, 2020 (afternoon) and paid rank of Subedar from 21st March, 2020 (forenoon) *vice* Number 103031 Subedar Sher Ali, Afridi proceeding on retiring pension with effect from 20th March, 2020 (afternoon).
12. Number 303413 Naib Subedar Habib Ur Rehman, Marwat (Signal Establishment) of Kurram Militia with effect from 18th August, 2019 (forenoon) *vice* Number 103150 Subedar Yousaf Khan, Khattak proceeding on retiring pension with effect from 17th August, 2019 (afternoon).
13. Number 1103267 Naib Subedar Ajoon Khan, Utman Khel (Signal Establishment) of Kurram Militia with effect from 20th January, 2020 (forenoon) *vice* Number 103159 Subedar Zafar Iqbal,



- Utman Khel proceeded on retiring pension with effect from 19th January, 2020 (afternoon).
14. Number 104267 Naib Subedar Ismail Mar Jan, Zadran of Kurram Militia with effect from 22nd January, 2020 (forenoon) *vice* Number 102859 Subedar Abdur Rehman, Zadran proceeded on retiring pension with effect from 21st January, 2020 (afternoon).
15. Number 203507 Naib Subedar Kifayat Hussain, Orakzai (Mechanical Transport Establishment) of Tochi Scouts with effect from 8th September, 2019 (forenoon) (from the date of confirmation as Naib Subedar) *vice* Number 202505 Subedar Umar Saeed proceeded on retiring pension with effect from 31st July, 2018 (afternoon).
16. Number 602231 Naib Subedar Sabz Ali Khan, Bhattani of Tochi Scouts with effect from 15th November, 2019 (forenoon) *vice* Number 601511 Subedar Said Azam, Bhattani proceeded on retiring pension with effect from 14th November, 2019 (afternoon).
17. Number 203237 Naib Subedar Adam Khan, Afridi (Signal Establishment) of Tochi Scouts with effect from 28th August, 2019 (forenoon) *vice* Number 202730 Subedar Muhammad Amin, Yousafzai (Signal Establishment) proceeded on retiring pension with effect from 27th August, 2019 (afternoon).
18. Number 203263 Naib Subedar Ubaid Ullah, Afridi (Signal Establishment) of Tochi Scouts with effect from 16th September, 2019 (forenoon) *vice* Number 202749 Subedar Islam Ghani, Khattak (Signal Establishment) proceeded on retiring pension with effect from 15th September, 2019 (afternoon).
19. Number 602215 Naib Subedar Khan Gul, Bhattani of Tochi Scouts with effect from 2nd July, 2019 (forenoon) *vice* Number 602088 Subedar Said Nawaz, Bhattani transferred to Khattak Scouts with effect from 1st July, 2019 (afternoon).
20. Number 602273 Naib Subedar Shawar Din, Bhattani of Tochi Scouts with effect from 10th February, 2020 (forenoon) *vice* Number 601604 Subedar Mavij Khan, Bhattani proceeded on retiring pension with effect from 9th February, 2020 (afternoon).
21. Number 203652 Naib Subedar Rehmat Karim, Orakzai (Mechanical Transport Establishment) of Tochi Scouts with effect from 1st August, 2019 (forenoon) *vice* Number 202140 Subedar Fazal Subhan, Khattak proceeded on retiring pension with effect from 18th January, 2018 (afternoon).
22. Number 203659 Naib Subedar Bahar Gul, Khattak (Mechanical Transport Establishment) of Tochi Scouts with effect from 1st August, 2019 (forenoon) *vice* Number 202408 Subedar Shamsher Khan, Khattak proceeded on retiring pension with effect from 18th July, 2018 (afternoon).
23. Number 202656 Naib Subedar Sher Nawaz, Khattak of Tochi Scouts with effect from 1st May, 2019 (forenoon) *vice* Number 202032 Subedar Lal Zaman, Khattak proceeded on retiring pension with effect from 30th April, 2020 (afternoon).
24. Number 203449 Naib Subedar Abdul Zada, Bangash (Mortar Establishment) of Tochi Scouts with effect from 1st August, 2019 (forenoon) (from the date of attaining of ACR 2019 in Naib Subedar Rank) *vice* Number 202179 Subedar Umar Hayat (Mortar Establishment) proceeded on retiring pension with effect from 23rd March, 2017 (afternoon).
25. Number 203017 Naib Subedar Khalid Hussain, Khattak of Tochi Scouts with effect from 14th December, 2019 (forenoon) *vice* Number 202168 Subedar Miro Khan, Khattak proceeded on retiring pension with effect from 13th December, 2019 (afternoon).
26. Number 202819 Naib Subedar Atiq Ur Rehman, Khattak of Tochi Scouts with effect from 27th September, 2019 (forenoon) *vice* Number 202110 Subedar Sami Ullah, Khattak proceeded on retiring pension with effect from 26th September, 2019 (afternoon).
27. Number 203604 Naib Subedar Naimat Khan, Banbash of Tochi Scouts with effect from 7th December, 2019 (forenoon) *vice* Number 103566 Subedar Ilyas Khan, Bangash proceeded on retiring pension with effect from 6th December, 2019 (afternoon).
28. Number 202832 Naib Subedar Khursheed Rehman, Khattak of Tochi Scouts with effect from 2nd October, 2019 (forenoon) *vice* Number 202120 Subedar Muhammad Rasheed, Khattak proceeded on retiring pension with effect from 1st October, 2019 (afternoon).
29. Number 203393 Naib Subedar Lal Akbar, Turi of Tochi Scouts with effect from 1st March, 2020 (forenoon) *vice* Number 202201 Subedar Abid Ali, Turi proceeding on retiring pension with effect from 29th February, 2020 (afternoon).
30. Number 1102215 Naib Subedar Zeer Akbar, Bhattani of South Waziristan Scouts with effect from 16th August, 2019 (forenoon) *vice* Number 302222 Subedar Amir Muhammad, Bhattani proceeded on retiring pension with effect from 15th August, 2019 (afternoon).
31. Number 303039 Naib Subedar Naz Ali Khan, Bhattani of South Waziristan Scouts with effect from 16th August, 2019 (forenoon) *vice* Number 302212 Subedar Ali Marjan, Bhattani proceeded on retiring pension with effect from 15th August, 2019 (afternoon).
32. Number 303355 Naib Subedar Masood Rehman, Bhattani of South Waziristan Scouts with effect from 1st November, 2019 (forenoon) *vice* Number 302255 Subedar Shahzad Gul,

- Bhittani proceeded on retiring pension with effect from 31st October, 2019 (afternoon). May, 2019 (forenoon) on existing vacancy 248 Wing Bhittani Rifles.
33. Number 302996 Naib Subedar Muhammad Rasool, Mangal of South Waziristan Scouts with effect from 16th May, 2019 (forenoon) in newly raised inducted Hazara Tribe. *TO BE NAIB SUBEDAR ON PROBATIONARY PERIOD OF SIX MONTHS*
34. Number 1001651 Naib Subedar Asghar Khan, Khattak (Signal Establishment) of South Waziristan Scouts with effect from 31st July, 2019 (forenoon) *vice* Number 302299 Subedar Zia Ullah proceeded on retiring pension with effect from 30th July, 2019 (afternoon).
35. Number 303122 Naib Subedar Sheikh Sultan, Bhittani (Field Battery) of South Waziristan Scouts with effect from 26th June, 2019 (forenoon) (from the date of confirmation as Naib Subedar) *vice* Number 302388 Subedar Nad Ali, Buda Khel proceeded on retiring pension with effect from 23rd August, 2018 (afternoon).
36. Number 303707 Naib Subedar Razim Ali, Orakzai (Mechanical Transport Establishment) of South Waziristan Scouts with effect from 16th May, 2019 (forenoon) *vice* Number 1201213 Subedar Sohail Khan, Bangash promoted Subedar Major from the same date.
37. Number 202901 Naib Subedar Saif Ullah, Khattak (Medical Establishment) of Thall Scouts with effect from 1st February, 2019 (forenoon) *vice* Number 901466 Subedar Asghar Khan, Afridi proceeded on retiring pension with effect from 31st January, 2019 (afternoon).
38. Number 1001630 Naib Subedar Niaz Gul, Mohmand (Signal Establishment) of Shawal Rifles with effect from 22nd September, 2019 (forenoon) *vice* Number 1001393 Subedar Muhammad Riaz, Afridi proceeded on retiring pension with effect from 21st September, 2019 (afternoon).
39. Number 404782 Naib Subedar Muhammad Nawaz, Chitrali of Shawal Rifles with effect from 16th January, 2020 (forenoon) *vice* Number 403990 Subedar Musa Khan, Chitrali proceeded on retiring pension with effect from 15th January, 2020 (afternoon).
40. Number 1002574 Naib Subedar Niaz Ud Din, Khattak of Khattak Scouts with effect from 16th May, 2019 (forenoon) *vice* Number 1102130 Subedar Umar Badshah, Khattak transferred to newly raised 226 Wing Khattak Scouts.
41. Number 404822 Naib Subedar Muhammad Saghir Shah, Chitrali of Bhittani Rifles with effect from 3rd October, 2018 (forenoon) (from the date of confirmation as Naib Subedar) *vice* Number 403986 Subedar Yahya Khan, Chitrali promoted Subedar Major with effect from 1st October, 2018 (forenoon).
42. Number 602702 Naib Subedar Niaz Wali, Bhittani of Bhittani Rifles with effect from 16th
43. Number 205599 Havildar Muhammad Khan, Marwat of Tochi Scouts with effect from 16th March, 2019 (forenoon) *vice* Number 202628 Naib Subedar Abdul Ullah, Marwat promoted Subedar from the same date.
44. Number 203588 Havildar Bahadar Khan, Khattak (Mortar Establishment) of Tochi Scouts with effect from 1st October, 2019 (forenoon) (from the date of qual of TTT-I) against higher post of Subedar *vice* Number 203374 Naib Subedar Asmat Ullah, Wazir transferred to 226 Wing Khattak Scouts with effect from 1st July, 2019 (forenoon).
45. Number 204994 Havildar Riayaz Khan, Mohmand of Tochi Scouts with effect from 29th October, 2019 (forenoon) (from the date of qual of TT-I) *vice* Number 203183 Naib Subedar Sartaj Khan, Mohmand promoted Subedar with effect from 1st October, 2018 (forenoon).
46. Number 203778 Havildar Naveed Ullah, Khattak of Tochi Scouts with effect from 27th September, 2019 (forenoon) *vice* Number 202819 Naib Subedar Atiq Ur Rehman, Khattak promoted Subedar from the same date.
47. Number 204026 Havildar Asghar Ali, Khattak of Tochi Scouts with effect from 14th December, 2019 (forenoon) *vice* Number 203017 Naib Subedar Khalid Hussain, Khattak promoted Subedar from the same date.
48. Number 204897 Havildar Ijaz Khan, Bangash of Tochi Scouts with effect from 7th December, 2019 (forenoon) *vice* Number 203604 Naib Subedar Naimat Khan, Bangash promoted Subedar from the same date.
49. Number 305876 Havildar Rooh Niaz, Wazir of South Waziristan Scouts with effect from 3rd August, 2019 (forenoon) (on completion of 12 years service) *vice* Number 902443 Naib Subedar Muhammad Shameem, Wazir transferred to 137 Wing South Waziristan Scouts with effect from 1st July, 2019 (forenoon).
50. Number 504565 Havildar Salim Ullah Khan, Wazir of Shawal Rifles with effect from 11th March, 2019 (forenoon) (from the date of qual of TT-I) *vice* Number 503106 Naib Subedar Muhammad Naseeb, Wazir promoted Subedar with effect from 2nd February, 2018 (forenoon).
51. Number 504707 Havildar Ashraf Ullah, Wazir of Shawal Rifles with effect from 17th June, 2019 (forenoon) (from the date of qual of TT-I) *vice* Number 203733 Naib Subedar Salim Ullah, Wazir permanent transferred to Frontier Corps Intelligence Unit with effect from 8th August, 2018 (afternoon).

52. Number 1002399 Havildar Ali Zaman, Bhattani of Shawal Rifles with effect from 17th June, 2019 (forenoon) (from the date of qual of TT-I) vice Number 1001441 Naib Subedar Ahmad Khan, Bhattani promoted Subedar with effect from 21st April, 2018 (forenoon).
53. Number 702708 Havildar Fateh Muhammad, Afridi (Signal Establishment) of Khattak Scouts with effect from 20th November, 2019 (forenoon) (from the date of qual of TTT-I) vice Number 503425 Naib Subedar Haleem Khan, Mohmand proceeded on retiring pension with effect from 26th August, 2019 (afternoon).
54. Number 105199 Havildar Liaqat Hussain, Turi of Khattak Scouts with effect from 3rd July, 2019 (forenoon) vice Number 702521 Naib Subedar Rizwan Hussain, Turi promoted Subedar from the same date.
55. Number 105192 Havildar Nazar Hussain, Turi of Khattak Scouts with effect from 16th May, 2019 (forenoon) on existing vacancy of Gandapor tribe for completion of command structure.
56. Number 105783 Havildar Khaider Khel, Maqbal of Khattak Scouts with effect from 6th December, 2019 (forenoon) vice Number 103561 Naib Subedar Ajmir Khan, Maqbal proceeded on retiring pension with effect from 5th December, 2019 (afternoon).
57. Number 1400130 Havildar Kalim Ullah, Khattak of Bhattani Rifles with effect from 2nd December, 2019 (forenoon) (from the date of qual of TT-I) vice Number 505557 Naib Subedar Shad Muhammad, Khattak promoted Subedar with effect from 9th November, 2019 (forenoon).
58. Number 205843 Havildar Rizwan Ullah, Wazir of Bhattani Rifles with effect from 18th October, 2019 (forenoon) (from the date of qual of TT-I) vice Number 204466 Naib Subedar Gul Sanar, Wazir embraced Shahadat on 16th March, 2019.
59. Number 304357 Havildar Niaz Muhammad, Kundi (Signal Establishment) of Bhattani Rifles with effect from 25th February, 2019 (forenoon) (from the date of qual of TTT-I) on existing vacancy of new raised 244 Wing Bhattani Rifles (Signal Establishment).
60. Number 602468 Havildar Mustafar Gul, Khattak (Medical Establishment) of Bhattani Rifles with effect from 19th October, 2019 (forenoon) vice Number 404577 Naib Subedar Fazal Akbar (Medical Establishment) proceeded on retiring pension with effect from 18th October, 2019 (afternoon).

#### Amendments

61. Please amend to read date of promotion to the rank of Subedar in respect of No. 103736 Havildar (now Naib Subedar) Wajid Khan, Khattak of Bhattani Rifles with effect from 1st February, 2017 (forenoon) instead of 11th February, 2017 (forenoon) in Record Wing KP (North) Gazette

Notification Number 22/Prom/33/X/RW dated 23rd May, 2017.

62. Please amend to read date of promotion to the rank of Subedar in respect of No. 303018 Havildar (now Naib Subedar) Muhammad Nisar, Afridi of Bhattani Rifles with effect from 1st February, 2017 (forenoon) instead of 15th February, 2017 (forenoon) in Record Wing (North) Gazette Notification Number 22/Prom/33/X/RW dated 23rd May, 2017.

SOHAIL SABIR, *Lieutenant Colonel,*  
For Inspector General.

#### OFFICE OF THE INSPECTOR GENERAL OF POLICE

[NATIONAL HIGHWAYS & MOTORWAY POLICE]

Karachi, the 26th February, 2020

**No. NHMP/Addl./IG/SR/301/20.**—Following DSsP/CPOs of NHMP N-5 South Zone are hereby granted monthly rest/casual leave with effect from the date mentioned against each.

S#	Name of Officers	Leave Granted	Look after Charge
1	Mr. Hammad Nasir CPO Beat-25 Daharki	06 days monthly rest from 5th March, 2020 to 10th March, 2020	A/CPO Syed Sibte-Hasnain Beat-26 Pano Aqil
2	Syed Rashid Ali Shah, CPO Beat-29 Kandiaro	02 days casual leave from 27th February, 2020 to 28th February, 2020	IP/SPO Qamar-Uz-Zaman, Admin Officer, Beat-29 Kandiaro
3	Hafiz Ahmed Noman, CPO Beat-31 Moro	04 days casual leave from 22nd February, 2020 to 25th February, 2020	IP/SPO Mehboob Illahi, Admin Officer, Beat-30 Moro
4	Mr. Hussnain Abbas, CPO Beat-30 Sakrand	06 days monthly rest leave from 22nd February, 2020 to 27th February, 2020	IP/SPO Arbab Ali Zardari Admin Officer, Beat-31 Sakrand
5	Mr. Haneef Arif, CPO Beat-35 Karachi	06 days monthly rest leave from 28th February, 2020 to 4th March, 2020	Mr. Israr Ali Tunio, CPO Beat-LEW

Karachi, the 27th February, 2020

**No. NHMP/Addl./IG/SR/302/19.**—Mr. Ghulam Sarwar Bhayo SP/PSP (BS-18) Sector Commander, Sector-I Sukkur, is hereby granted two (02) days casual leave on 3rd March, 2020 & 4th March, 2020.

2. Mr. Muhammad Younis Khan DSP/CPO, LHQ-I, Sukkur, will look after the duties of Sector Commander, Sector-I Sukkur during the leave period of officer in addition to his own duties.

**No. NHMP/Addl./IG/SR/303/20.**—Upon appointment in National Highways & Motorway Police (NHMP) on the

recommendations of Federal Public Service Commission, Mr. Sunny Kumar S/o. Bhagchand, Accountant (BS-16) has joined his duty on 19th February, 2020 and further posted at Zonal Office, Karachi with immediate effect till further orders.

2. Wherefrom, Accountant (BS-16) Mr. Mustafa Ali, presently posted at Zonal Office, Karachi is hereby transferred and posted to Sector N-55 (Indus Highway) Sehwan with immediate effect till further order.

DR. AFTAB AHMED PATHAN, PSP,  
Additional Inspector General.

Quetta, the 24th February, 2020

**No. NHMP/DIG/(West)AD/HRM-I/2020/85.**—Rao Muhammad Iqbal DSP-CPO (BS-17) of Beat-I Hub, Sector-I, N-25, Uthal is hereby granted 06-days Monthly Rest alongwith 04-days Casual Leave with effect from 25th February, 2020 to 5th March, 2020.

During the leave period, Admin Officer of Beat-I Hub Sector-I, N-25, Uthal will look after the routine affairs in addition to his own assignment in existing pay/scale.

**No. NHMP/DIG/(West)AD/HRM-I/2020/84.**—In partial modification of this office Notification No. NHMP/DIG/(West)AD/HRM-I/20/68 dated 18th February, 2020, 10-days Monthly Rotation alongwith 02-days Casual Leave already sanctioned to Mr. Shafiq-ur-Rahman DSP/CPO (BS-17) of Beat-II, Pasni, N-10, Gwader from 23rd February, 2020 onward, is hereby rescheduled from 28th February, 2020 to 10th March, 2020 at his own request due to shifting of Beat Pasni and offices to a new building.

2. During the leave period, IP/SPO Daulat Khan, Admin Officer of Beat-II Pasni, Sector N-10, Coastal Highways Gwader will look after the routine affairs of Beat-II, Pasni, in addition to his own assignment in existing pay/scale.

Quetta, the 25th February, 2020

**No. NHMP/DIG/(West)AD/HRM-I/2020/89.**—Mr. Akhtar Muhammad Achakzai DSP-CPO Beat-13, Mastung, Sector-III, N-25, RCD Kalat is hereby granted 04-days Rotation Leave alongwith 06-days Casual Leave with effect from 27th February, 2020 to 7th March, 2020.

During the leave period, Admin Officer of Beat-13 Mastung Sector-III, N-25, RCD Kalat will look after the routine affairs of Beat-13 Mastung, Sector-III N-25, RCD Kalat in addition to his own assignment in existing pay/scale.

**No. NHMP/DIG/(West)AD/HRM-I/2020/90.**—Sardar Muhammad Qaiser Khan DSP-CPO Beat-03, Uthal Sector-I, N-25, Uthal is hereby granted 06-days Rotation Leave alongwith 04-days Casual Leave with effect from 28th February, 2020 to 8th March, 2020.

During the leave period, Admin Officer of Beat-03 Uthal Sector-I, N-25, Uthal will look after the routine affairs of Beat-03 Uthal Sector-I, N-25, Uthal in addition to his own assignment in existing pay/scale.

ALI SHER JAKHRANI, PPM, PSP,  
Deputy Inspector General.

Islamabad, the 21st February, 2020

**No. NHMP/N-10(1)/HRM/2020/SPO/430.**—IP/SPO Mr. Ghulam Abbas, S-716 is hereby transferred from M-4 Zone to Motorway Zone, with immediate effect and until further orders.

The above mentioned officer shall be relieved immediately with the direction to report at his new place of posting within actual permissible travelling time as provided in Circular issued *vide* No. NHMP-2 (4) / 12/ SOP/ Estt/1385 dated 22nd July, 2015.

Upon relieving of the officer from M-4 Zone, his duty completed and updated Service Record & Last Pay Certificate (LPC) be sent to Motorway Zone, within 07-days.

This issues with the approval of Inspector General of Police, NHMP.

**No. NHMP-42(7)/2020/HRM/PO/429.**—SPO Mr. Muhammad Tehsin of Punjab Police, presently serving in NHMP on deputation basis and posted in N-5 Central Zone is hereby repatriation from National Highways & Motorway Police (NHMP) to his parent department *i.e.* Punjab Police, in his substantive rank and relevant pay & allowances on completion of maximum deputation period in NHMP on his own request.

The above named officer may be relieved by Zonal Office *vide* Daily Diary (Roznamcha) maintained at Zonal Office wherein directions be conveyed to concerned Sector/ Beat Commander for his formal relieving. However, LPC be issued after receipt of uniform articles, Arms & Ammunition and E-Card issued to the officers and clearance from all concerned sections including R&W Fund.

This issues with the approval of Inspector General of Police, NHMP.

**No. NHMP/N-29(1)/19/HRM/SPO/431.**—IP/SPO Mr. Khizar Hayat, S-1183 presently posted in Motorway Zone is hereby granted 365 days earned leave with effect from 25th February, 2020 to 23rd February, 2021 as per following specification:-

Leave on Full Pay	=	120 days
Leave on half average pay	=	245 days

2. Motorway, no request for extension in leave will be entertained and on expiry of said leave, the officer shall report at his present place of posting on 24th February, 2021, otherwise, strict disciplinary action under NHMP (E&D) Rules, 2016 will be taken by the concerned Supervisory Officer against him under intimation to all concerned.

3. This issues with the approval of Inspector General of Police, NHMP.

Islamabad, the 24th February, 2020

**No. NHMP/N-3(14)/19/Policy/West/463.**—In partial modification of this office earlier Notification No. NHMP-3 (14)/HRM/19/Policy/West/397 dated 19th February, 2020.

The transfer order upto the extent of IP/SPO Atif Ghafoor Bhatti, No. S-699 from PLHQ Zone, NHMP, Islamabad to West Zone is hereby cancelled/withdrawn with effect of the date of its issuance, for one time only.

Rest of the order holds good.

This issues with the approval of Inspector General, NHMP.

Islamabad, the 26th February, 2020

**No. NHMP-42(7)/2019/HRM/SPO/486.**—Inspector Dr. Mustafa Hussain Kalhoro, K-2868 of Sindh Police, presently serving in NHMP on deputation basis as SPO (BS-16) and posted in CPO/HQs Zone is hereby repatriated from National Highways & Motorway Police (NHMP) to his parent department *i.e.* Sindh Police, in his substantive rank and relevant pay & allowances on premature basis with immediate effect.

The above named officer shall be relieved by Zonal Office *vide* Daily Diary (Roznamcha) maintained at Zonal Office wherein directions be conveyed to concerned Sector/ Beat Commander for his formal relieving. However, LPC be issued after receipt of uniform articles, Arms & Ammunition and departmental E-Card issued to the officers and clearance from all concerned sections including R&W Fund.

This issues with the approval of Inspector General of Police, NHMP.

Islamabad, the 27th February, 2020

**No. NHMP-6-(2)/2012/HRM/DSP/498.**—Following officers of NHMP are hereby transferred and posted to the Zones as mentioned against each with immediate effect and until further orders:-

S#	Name & Rank of Officers	From	To
1	Mr. Ehsan Danish Kalyar, DSP/CPO (BS-17)	M-4 Zone	Motorway Zone
2	Mr. Afzal Majeed, DSP/CPO (BS-17)	Motorway Zone	M-4 Zone
3	Mr. Yasir Zufiqar, DSP/CPO (BS-17)	Motorway Zone	M-4 Zone
4	Mr. Masroor Ali, DSP/CPO (BS-17)	West Zone	M-5 Zone

2. The above mentioned officers shall be relieved immediately with the direction to report at their new places of posting mentioned against each within actual permissible time.

3. This issues with the approval of Inspector General of Police, NHMP.

SYED HASHMAT KAMAL, PSP.,  
Assistant Inspector General (HRM).

PAKISTAN INSTITUTE OF MEDICAL SCIENCES

Islamabad, the 21st February, 2020

**No. PF. 001-R/P/Admin-PIMS.**—In pursuance of Ministry of NHS,R&C Letter No. F. 1-717/2019-Estab-III dated 13th February, 2020, Prof. Anser Maxood, Prof. of Dentistry (BPS-20), presently holding current charge of the post of Executive Director (BPS-21), PIMS, Islamabad is allowed to draw leave encashment of 365 days pay in lieu of LPR. The will retire from service with effect from 14th January, 2021.

**No. F. 1-14/2019/MO(Admin)IH.**—Dr. Zahid Waqar, Medical Officer (BPS-17) has been granted 23 days leave with full pay with effect from 21st February, 2020 to 13th March, 2020.

This issues with the approval of Executive Director.

Islamabad, the 24th February, 2020

**No. PF. 0074-R/S.R/(Admin)/PIMS.**—In continuation of this Institute notification of even number dated 11th February, 2020, Dr. Sumaira Nabi, Senior Registrar (Neurology) has been granted 07 days extension of Medical leave with full pay with effect from 11th February, 2020 to 17th February, 2020.

This issues with the approval of Executive Director.

**No. PF. 3-21(F)MCH/Admin.**—Dr. Fariha, Medical Officer of MCH, Centre here by granted 22 days *ex-Pakistan* leave with full pay with effect from 29th February, 2020 to 21st March, 2020 to perform Umrah. She will resume her duty on 22nd March, 2020 on the same place.

This Institute has no objection on her proceeding abroad to Saudi Arabia.

This issues with the approval of Executive Director, PIMS.

**No. PF. 0071-R/A.P/(Admin)/PIMS.**—Dr. Ahmed Farhan, Assistant Prof. of General Medicine has been granted 14 days *ex-Pakistan* leave with full pay with effect from 8th March, 2020 to 21st March, 2020 to perform Umrah.

PIMS has no objection on his proceeding to Kingdom of Saudi Arabia.

This issues with the approval of Executive Director.

Islamabad, the 25th February, 2020

**No. F. 1-14/2019/MO(Admin)IH.**—Dr. Awais Karim, Medical Officer (BPS-17) has been granted 08 days leave with full pay with effect from 24th February, 2020 to 2nd March, 2020.

**No. F. 1-14/2019-MO(Admin)IH.**—Dr. Azka Ali, Medical Officer (BPS-17) has been granted 90 days maternity leave with full pay with effect from 1st February, 2020 to 30th April, 2020.

This issues with the approval of Executive Director.

Islamabad, the 28th February, 2020

**No. PF. 006-R/A.P/(Admin)/PIMS.**—Dr. Aatif Inam, Assistant Prof. of General Surgery has been granted 30 days leave with full pay with effect from 21st February, 2020 to 22nd March, 2020. Dr. Muhammad Burhan ul Haq, Assistant Prof. of Gen. Surgery will look after his duties in addition to his own.

This issues with the approval of Executive Director.

**No. F. 1-14/2019-MO(Admin)IH.**—Dr. Nazish Kazim, Medical Officer (BPS-17) has been granted 45 days maternity leave with full pay with effect from 15th February, 2020 to 30th March, 2020.

This issues with the approval of Executive Director.

DR. ANJUM JAVED,  
Joint Executive Director.

Islamabad, the 22nd February, 2020

**No. PF. 2-776(AAR)2019-CH(Admin).**—Dr. Ayesha Abdul Razzaq, Medical Officer (BS-17) is hereby granted 90 days maternity leave (1st time) with effect from 11th February, 2020 to 10th May, 2020.

Islamabad, the 25th February, 2020

**No. PF. 2-779(MN)2019-CH(Admin).**—Dr. Maryam Naseer, Medical Officer, Children Hospital is hereby granted 17 days leave with full pay as under:-

a) From 1st January, 2020 to 7th January, 2020.

b) From 13th January, 2020 to 23rd January, 2020.

DR. ZULFIQAR GHOURI,  
Director.

[MOTHER & CHILD HEALTH CENTRE]

Islamabad, the 25th February, 2020

**No. PF. 7-85(NJ)MCH/Admin.**—Ms. Naila Jesse, Charge Nurse of MCH, Centre is hereby granted 28 days leave with full pay with effect from 30th January, 2020 to 26th February, 2020. She will resume her duty on 27th February, 2020 on the same place.

**No. PF. 7-40(ZK)MCH/Admin.**—In continuation to this Office notification of even number dated 19th February, 2020, leave with full pay of Mst. Zainab Khatoon, Charge Nurse of MCH Centre here by extended for further period of 10 days with effect from 26th February, 2020 to 6th March, 2020. She will resume her duty on 7th March, 2020 on the same place.

Islamabad, the 27th February, 2020

**No. PF. 7-59(MM)MCH/Admin.**—Ms. Mamoona Malik, Charge Nurse of MCH, Centre is hereby granted 05 days leave with full pay with effect from 20th February, 2020 to 24th February, 2020 on medical grounds.

**No. PF. 7-20(AA)MCH/Admin.**—Ms. Azra Amin, Charge Nurse of MCH, Centre is hereby granted 07 days leave with full pay with effect from 11th February, 2020 to 17th February, 2020 on medical grounds.

**No. PF. 7-14(SB)MCH/Admin.**—Ms. Shehnaz Bivi, Charge Nurse of MCH, Centre is hereby granted 02 days leave with full pay with effect from 31st January, 2020 to 1st February, 2020 on medical grounds.

**No. PF. 7-44(N)MCH/Admin.**—Ms. Nazmeen, Charge Nurse of MCH, Centre is hereby granted 10 days leave with full pay with effect from 3rd March, 2020 to 12th March, 2020. She will resume her duty on 13th March, 2020 on the same place.

HUMERA KHUSHNUD,  
Chief Nursing Superintendent.

PAKISTAN POST

[DIRECTORATE GENERAL PAKISTAN POST]

Islamabad, the 10th March, 2020

**No. CP. 5-10/2003-XVI.**—On the recommendations of Departmental Promotion Committee and with the approval of the competent authority viz Deputy Director General (Admn) Dte-General, Pakistan Post, Islamabad, Syed Nasir Shah, Assistant (BPS-16) is appointed to the post of Superintendent (BPS-16) in the Directorate General, Pakistan Post Office, Islamabad on acting charge basis with effect from date he actually assumes the charge of the post of Superintendent (BS-16).

Islamabad, the 13th March, 2020

**No. Staff-1179-III.**—In pursuance of Ministry of Communications Letter No. 7-11/2015-P.O.I (Vol-I) dated 9th March, 2020, the Director General, Pakistan Post has been pleased to relieve Dr. Najeeb-ur-Rehman, a (BPS-19) Postal Group Officer to join his new assignment in the People's Primary Healthcare Initiative (PPHI) Sindh as Regional Director on deputation basis for a period of three years on standard terms and conditions.

**No. Staff-1267.**—In pursuance of Ministry of Communications Letter No. 7-11/2015-P.O.I (Vol-I) dated 9th March, 2020, the Director General, Pakistan Post has been pleased to relieve Mr. Umer Bashir Bajwa, a (BPS-18) Postal Group Officer to join his new assignment in the People's Primary Healthcare Initiative (PPHI) Sindh as District Manager on deputation basis for a period of three years on standard terms and conditions.

AHMED ARBAB ABID,  
Assistant Deputy Director General (HR).

SECRETARIAT TRAINING INSTITUTE

Islamabad, the 31st March, 2020

**No. F. 4-1/2019-SOPE.**—Consequent upon the completion of Specialized Training Programme and in

pursuance of Establishment Division's Notification No. F. 6/1/2019-E-VII, dated 31st March, 2020, the following Section Officers of SOPE-2017 (BS-17) are relieved from STI to join their respective Ministries/Divisions, Accordingly they have relinquished the charge of the post of Section Officer (Probationer) (BS-17) in the Secretariat Training Institute, Islamabad with effect from 31st March, 2020.

S #	Name of Officers
1	Mr. Tariq Mehmood
2	Mr. Muhammad Abrar Azam
3	Mr. Akram Shafique
4	Mr. Muhammad Amjad Alam Sher Malik
5	Mr. Muhammad Arfan
6	Ms. Samreen Khan
7	Mr. Sher Alam Khan
8	Mr. Imran Hussain
9	Mr. Mumtaz Ahmed
10	Mr. Muhammad Shafique

S #	Name of Officers
11	Mr. Muhammad Shehzad
12	Mr. Muhammad Siddique
13	Mr. Faisal Malik
14	Mr. Muhammad Razaullah Lakho
15	Mr. Ashar Mahmood
16	Mr. Yasir Choudhary
17	Mr. Abdul Rauf
18	Mr. Asif Mahmood

TAHIRA SALEEM,  
Deputy Director (OMG).

**WORKERS WELFARE FUND**

Islamabad, the 27th March, 2020

**No. 10-1(28)/2016-Admn.**—In pursuance of Federal Board of Revenue Notification No. 0527-IR-I/2020 dated 20th March, 2020, Mr. Muhammad Qasim Samad Khan, a BS-20 Officer of Inland Revenue Service, posted as Secretary (BS-20), Workers Welfare Fund under the Ministry of Overseas Pakistanis & Human Resource Development on deputation under Section 10 of the Civil Servants Act, 1973, on his promotion to BS-21 has relinquished the charge of the post of Secretary, Workers Welfare Fund with effect from 27th March, 2020.

SAUD-UR-REHMAN,  
Deputy Director (Admn).

# The Gazette of Pakistan



PUBLISHED BY AUTHORITY

KARACHI, WEDNESDAY, JULY 15, 2020

## PART IV

### Notifications issued by the minor administrations and miscellaneous notifications not included in any other part

ISLAMABAD CAPITAL TERRITORY, CO-OPERATIVES  
DEPARTMENT

Islamabad, the 6th July, 2020

**No. 2464/CR/ICT/B.**—Consequent upon completion of tenure of 03 years of the Managing Committee of Islamabad Farming Cooperative Society, Islamabad on 18th July, 2020, the Managing Committee of the Society is hereby dissolved and Mr. Aneel Salman, Assistant Commissioner (UT), ICT, Islamabad is hereby appointed as Administrator of the Society for the period of 60 days or until holding of fresh elections of Society.

2. The Administrator is assigned the following tasks :-

- i) The Administrator shall make necessary arrangements in coordination with Cooperative Societies Department and Election Commission to hold elections of the Managing Committee of the Society within stipulated period.
- ii) The Administrator shall not make any allotment of plots, whether fresh or pending, initiate any development work or make any payments pertaining to any development work and sale or purchase of land or any other payment except salary of staff and utility bills.
- iii) No fresh appointment of any employee shall be made except with the approval of the Registrar.
- iv) The Administrator shall facilitate and discharge his duties and obligations as laid down in Byelaws of the Society.
- v) The Administrator shall take over proper charge of the Society.
- vi) The Administrator shall not be entitled for any remuneration of his services.

vii) The Administrator shall submit monthly report to the Registrar Cooperative Societies, Islamabad regarding affairs of the Society.

3. The Administrator may withdraw remuneration @ Rs. 10,000/- per month as per policy.

4. This issues with the approval of the Deputy Commissioner / Registrar Cooperative Societies, ICT, Islamabad.

ASGHAR KHAN NIAZI,  
Circle Registrar,  
Cooperative Societies Department.

MINISTRY OF NATIONAL FOOD SECURITY AND  
RESEARCH

Islamabad, the 4th May, 2020

**No. F. 1-3/2019-CC/NFSR.**—In continuation of earlier notification of even number, dated 11th March, 2020, the committee on Cotton Intervention Price is hereby revised with the following composition :-

*Chairman:*

1. Syed Fakhar Imam, Minister NFSR.

*Members :*

2. Mr. Omar Hamid, Secretary NFSR.
3. Mr. Naveed Kamran Baloch, Secretary Finance
4. Mr. Yousaf Naseem Khokhar, Secretary Commerce.
5. Mr. Wajid Rana, IFPRI Islamabad.
6. Dr. Amanullah Qasim, Mechiyara, Chairman APTMA.



*Members :*

7. Mian Javed Shohil, Chairman Pak Cotton Ginners Association.
8. Mr. Shan Ali Jonaijo Cotton Grower.
9. Mr. Khalid Khokar Grower.
10. Dr. Javed Humayoun DG Agriculture Policy Institute.
11. Khawaja Anis, APTMA
12. Mian Mahmood (Cotton Ginner)
13. Mr. Imran Junejo, Cotton Grower
14. Mr. Bilal Israel, Cotton Grower
15. Mr. Atif Dada, KCA

*Member / Secretary :*

16. Dr. Khalid Abdullah, Cotton Commissioner

a High Level Committee for coordination between civil and military organizations has been constituted, comprising of the following members ;

*Chairman:*

- i. Federal Minister for Science & Technology.

*Members :*

- ii. DG (Commercial Open Projects), SPD
- iii. Chairman R&D Advisory Board, SPD.
- iv. Secretary, Ministry of Science & Technology.
- v. DG, MVRDE, Ministry of Defence Production
- vi. DG (Ops & Plans), JSHQ
- vii. DG (Technical), Dte. Gen. ISI
- viii. Joint Electronic Adviser, Ministry of Science & Technology

*Secretary of the Committee :*

- ix. Joint Technological Adviser, Ministry of Science & Technology.

**TOR of the Committee :**

- a. To deliberate on various options of farmer support mechanisms.
  - b. Determine the intervention price for the year 2020-2021.
  - c. Recommend an appropriate intervention mechanism with time lines.
  - d. Assess funds requirement for such intervention.
2. The Committee can co-opt additional member(s) for its deliberation, if required.

2. The ToRs of the Committee are given below ;

- a. To deliberate about the different ongoing and proposed projects especially in Artificial Intelligence, Water & Food Security, Electronics, Space Technology, Naval Technology, Nanotechnology, Lasers & Photonics, Ocean Resources, Information & Communication Technologies and Material Science etc.
- b. Committee to deliberate and identify the core areas for research and development in Civil and Military Organizations.
- c. Committee may submit its recommendations / proposals to the Planning Division for inclusion in PSDP.

DR. KHALID ABDULLAH,  
Cotton Commissioner.

MINISTRY OF SCIENCE & TECHNOLOGY

Islamabad, the 10th June, 2020

**No. 6(30)/2017-ATA-I.**—With the approval of the Honourable Prime Minister of Islamic Republic of Pakistan,

SADAQAT KHAN,  
Assistant Technological Adviser.

# The Gazette of Pakistan



**PUBLISHED BY AUTHORITY**

**KARACHI, WEDNESDAY, JULY 15, 2020**

## **PART V**

**Notifications, etc., issued by The Patent Office**

### **NEW APPLICATIONS FOR THE PATENTS**

**24th September, 2019**

The dates shown in the crescent brackets are the dates claimed under section 86 of the Patents Ordinance 2000.

**23rd September, 2019**

636/2019 QINGDAO HAIER AIR CONDITIONER GENERAL CORP., LTD, China (Priority 1st November, 2018, CN).—"Method and system for reminding to clean purification module and air conditioner".

637/2019 QINGDAO HAIER AIR CONDITIONER GENERAL CORP., LTD, China (Priority 13th September, 2018, CN).—"Air conditioner".

638/2019 QINGDAO HAIER AIR CONDITIONER GENERAL CORP., LTD, China (Priority 13th September, 2018, CN).—"Control method for air conditioner".

639/2019 QINGDAO HAIER AIR CONDITIONER GENERAL CORP., LTD, China (Priority 13th September, 2018, CN).—"Control method for air conditioner".

640/2019 Prof. Dr. Farzana Shaheen, Hunain Ali and Dr. Almas Jabeen, Pakistan.—"Anticancer furan conjugated peptidomimetics".

641/2019 Sudharshan K.C., Nepal (Priority 26th September, 2018, NP).—"Production of Mechanical/Electrical Energy from Heat Energy with and by the use of Buoyancy Factor on Evaporation or Sublimation and Condensation".

642/2019 Prof. Dr. Faisal Shafait, Muhammad Abdullah Anjum, Shoaib Nasir & Abdul Rehman bin Saad, Pakistan.—"Tele Doc: A New Approach to Diagnostic Screening"

643/2019 NIHA CORPORATION, U.S.A.—"BIO-AUGMENTED FERTILIZER WITH ACCILIMITIZED HALOTOLERANT EFFECTIVE MICROORGANISMS AND METHODS FOR PRODUCING THE SAME".

644/2019 Monsanto Technology LLC, U.S.A. (Priority 25th September, 2018, US).—"NOVEL INSECT INHIBITORY PROTEINS".

**25th September, 2019**

645/2019 XEROS LIMITED, United Kingdom (Priority 26th September, 2018, UK).—"Apparatus and method for treating a substrate with solid particles".

**26th September, 2019**

646/2019 CASALE SA, Switzerland (Priority 28th September, 2018, EP).—"A perforated-tray column and a method of revamping the same".

647/2019 TIZONA THERAPEUTICS, U.S.A. (Priority 4th June, 2019, US).—"ANTI-HLA-G ANTIBODIES, COMPOSITIONS COMPRISING ANTI-HLA-G ANTIBODIES AND METHODS OF USING ANTI-HLA-G ANTIBODIES".

648/2019 FMC Corporation, U.S.A. (Priority 27th September, 2018, US).—"PYRIDAZINONE HERBICIDES AND PYRIDAZINONE INTERMEDIATES USED TO PREPARE A HERBICIDE".

649/2019 Enanta Pharmaceuticals, Inc., U.S.A. (Priority 21st September, 2018, US).—"MACROCYCLIC PROLINE DERIVED HCV SERINE PROTEASE INHIBITOR".

27th September, 2019

650/2019 FMC Corporation, U.S.A. (Priority 27th September, 2018, US).—"CATALYZED AND GREEN PROCESS OF MALATHION".

**APPLICATION ACCEPTED**

Notice is hereby given that the person interested in opposing the grant of Patents to any of the applications referred to below at any time within four months from the date of this Patents' journal may give notice at the Patent Office on the prescribed Form P-7 of the Patents Rules 18(1) of 2003.

The six figures number shown in the right hand side are those given to applications on acceptance of the complete specification under which the specification will be printed and subsequent proceeding taken.

The figures shown within square brackets after the title of inventions indicate their classification index at acceptance.

Typed copies of the specification which are to open to public inspection can be supplied by the Patent Office on payment of the prescribed charges which may be ascertained on application to the office.

698/2010 Huntsman Advanced Materials (Switzerland) GmbH, Switzerland.—"Fibre-reactive azo dye and its preparation".

C09B62/44, C09D11/00

143288

Reactive dye of the formula

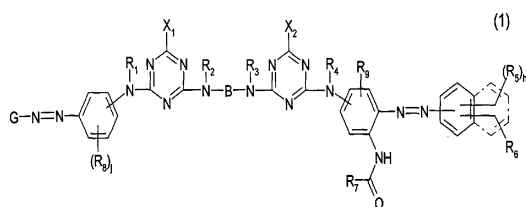

wherein

B is an aliphatic bridging member,

G is a sulfo naphthalene group or a sulfo benzene group of the formula

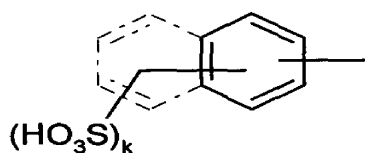

(2a) or

a pyridone radical of the formula

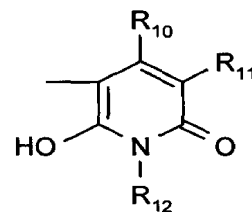

(2b),

R<sub>1</sub>, R<sub>2</sub>, R<sub>3</sub> and R<sub>4</sub> are each independently of the others hydrogen or unsubstituted or substituted C<sub>1</sub>-C<sub>4</sub>alkyl,

(R<sub>5</sub>)<sub>h</sub> denotes h identical or different substituents selected from the group sulfo, C<sub>1</sub>-C<sub>4</sub>alkyl and C<sub>1</sub>-C<sub>4</sub>alkoxy,

R<sub>6</sub> is hydrogen, sulfo, halogen, carboxy, C<sub>1</sub>-C<sub>4</sub>alkyl, C<sub>1</sub>-C<sub>4</sub>alkoxy or a fibre-reactive group Z<sub>1</sub> of the formula

-SO<sub>2</sub>-Y-NH-CO-(CH<sub>2</sub>)<sub>1</sub>-SO<sub>2</sub>-Y-CONH-(CH<sub>2</sub>)<sub>m</sub>-SO<sub>2</sub>-Y(3c), -NH-CO-CH(Hal)-CH<sub>2</sub>-Hal

(3d) or

NH-CO-C(Hal)=CH<sub>2</sub> (3e),

R<sub>7</sub> is amino, C<sub>1</sub>-Caalkyl or a fibre-reactive group

Z<sub>2</sub> of the formulaNH-(CH<sub>2</sub>)<sub>n</sub>-SO<sub>2</sub>-Y (3a),

(R<sub>8</sub>)<sub>j</sub> denotes j identical or different substituents selected from the group sulfo, C<sub>2</sub>-C<sub>4</sub>alkanoylamino, ureido, C<sub>1</sub>-C<sub>4</sub>alkyl and C<sub>1</sub>-C<sub>4</sub>alkoxy,

R<sub>9</sub> is hydrogen, C<sub>1</sub>-C<sub>4</sub>alkyl or C<sub>1</sub>-C<sub>4</sub>alkoxy,

R<sub>10</sub> is hydrogen or C<sub>1</sub>-C<sub>4</sub>alkyl,

R<sub>11</sub> is hydrogen, cyano, carbamoyl or sulfomethyl, and

R<sub>12</sub> is hydrogen, C<sub>1</sub>-C<sub>4</sub>alkyl, or phenyl which is unsubstituted or substituted by C<sub>1</sub>-C<sub>4</sub>alkyl, C<sub>1</sub>-C<sub>4</sub>alkoxy, C<sub>2</sub>-C<sub>4</sub>alkanoylamino, ureido, halogen or sulfo,

X<sub>1</sub> and X<sub>2</sub> are halogen,

Hal is chlorine or bromine,

h and j are each independently of the other a number 0, 1 or 2,

k is a number 1, 2 or 3,

l, m and n are each independently of the other a number 2, 3 or 4, and

Y is vinyl or a radical -CH<sub>2</sub>-CH<sub>2</sub>-U and U is a group removable under alkaline conditions, with the proviso that the dye of formula (1) contains at least one fibre-reactive group Z<sub>1</sub> or Z<sub>2</sub> are suitable for dyeing cellulosic or amide-group-containing fibre materials.

935/2011

DyStar Colours Distribution GmbH, Germany.—"DISAZO DYES, PREPARATION AND USE".

C09B31/153 &amp; C09D11/02.

143289

Described are dyes of formula (I)

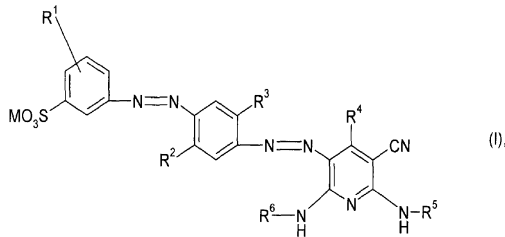

where  $R^1$  is hydrogen, alkyl, alkoxy, trifluoromethyl or halogen, M is hydrogen, an alkali metal cation or an optionally substituted ammonium cation,  $R^2$  and  $R^3$  are each independently hydrogen, alkyl or alkoxy,  $R^4$  is alkyl or alkoxy,  $R^5$  and  $R^6$  are each independently moieties of the formula  $-(C_mH_{2m})-O-C_nH_{2n+1}$ , m is an integer from 3 to 6, and n is an integer from 0 to 8. These dyes are useful for dyeing and printing materials having polar groups.

224/2012

Huntsman Advanced Materials (Switzerland) GmbH, Switzerland.—“FIBRE-REACTIVE DYE AND ITS PREPARATION”.

D06P1/384, D06P3/66, C07C317/44, C09B62/475, C09B 62/44, C09B 62/513 & C09D11/00.

143290

Reactive dye of formula

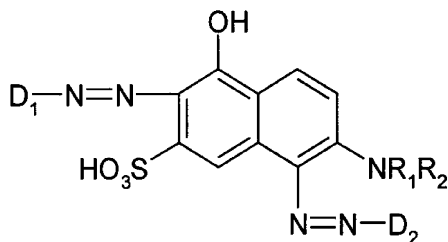

wherein

$R_1$  and  $R_2$  are each independently of the other hydrogen or unsubstituted or substituted  $C_1$ - $C_4$ alkyl, one of the radicals  $D_1$  and  $D_2$  is a radical of the formula

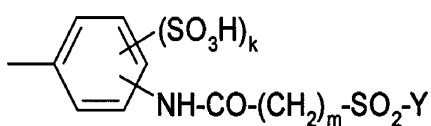

the other one of the radicals  $D_1$  and  $D_2$  is a radical of the formula

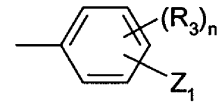

(3a), or

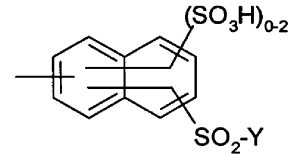

(3b),

wherein

$(R_3)_n$  denotes n identical or different substituents selected from the group  $C_1$ - $C_4$ alkyl,  $C_1$ - $C_4$ alkoxy and sulfo,

$Z_1$  is a radical of the formula

$-SO_2-Y$

$-CONH-(CH_2)_p-SO_2-Y$

$NH-CO-CH(Hal)-CH_2-Hal$

(4c),

$NH-CO-C(Hal)=CH_2$

(4d), or

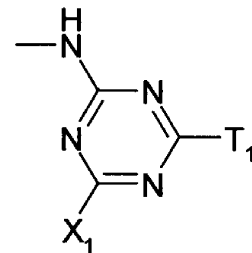

(4e),

wherein

$X_1$  is halogen,

$T_1$  independently has the definition of  $X_1$ , is a non-fibre-reactive substituent or is a fibre-reactive radical of the formula

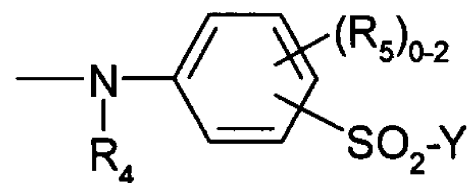

(5a),

$NH-(CH_2)_2-3-SO_2-Y$

or

$-NH-(CH_2)_2-3-O-(CH_2)_2-3-SO_2-Y$

$R_4$  is hydrogen or unsubstituted or substituted  $C_1$ - $C_4$ alkyl,

$(R_5)_{0-2}$  denotes from 0 to 2 identical or different substituents from the group  $C_1$ - $C_4$ alkyl,  $C_1$ - $C_4$ alkoxy and sulfo,

Hal is halogen,

Y is vinyl or a  $-\text{CH}_2-\text{CH}_2-\text{U}$  radical and U is a group that is removable under alkaline conditions,

k is the number 0, 1 or 2,

m is the number 2, 3 or 4,

n is the number 0, 1 or 2, and

p is the number 2, 3 or 4,

are suitable for dyeing cellulosic or amide-group-containing fibre materials.

248/2012 Huntsman Advanced Materials (Switzerland) GmbH, Switzerland.—“Method of Dyeing Polyester”.

D06P1/16, D06P1/18, D06P3/54, D06P1/642, D06P3/52 & D06P1/64.

143291

The present invention relates to a method of dyeing polyester-containing textile material characterised in that the textile material is treated with a liquor containing (a) at least one disperse dye and (b) at least one compound of the formula

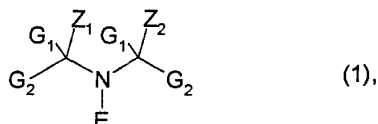

wherein  $G_1$  and  $G_2$ , independently of one another, are  $C_1-C_4$ alkyl or together are pentamethylene,  $Z_1$  and  $Z_2$  are methyl, or  $Z_1$  and  $Z_2$  together form a bridging member which is unsubstituted or substituted by an ester, ether, hydroxyl, oxo, cyanohydrin, amido, amino, carboxyl or urethane radical, and E is oxyl or hydroxyl.

34/2013 F. Hoffmann-La Roche AG and Siena Biotech S.p.A, Switzerland.—“Fluoromethyl-5,6-dihydro-4H-[1,3]oxazine”.

C 07D401/12, C07D 403/12, C07D 413/12, A61K 31/5355 & A61K31/535.

143292

The present invention provides a compound of formula I

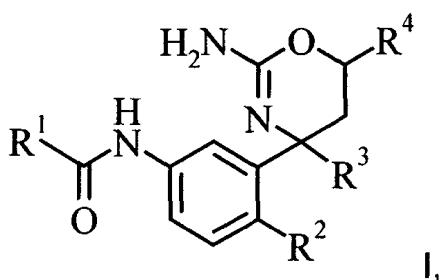

having BACE1 inhibitory activity, their manufacture, pharmaceutical composition containing them and its use as therapeutically active substance, wherein

$R^1$  is selected from the group consisting of

aryl,

aryl substituted by 1-4 substituents individually selected from cyano, cyano- $C_{1-6}$ -alkyl, halogen, halogen- $C_{1-6}$ -alkoxy, halogen- $C_{1-6}$ -alkyl,  $C_{1-6}$ -alkoxy,  $C_{1-6}$ -alkoxy- $C_{1-6}$ -alkyl,  $C_{2-6}$ -alkynyl- $C_{1-6}$ -alkoxy,  $C_{2-6}$ -alkynyl and  $C_{1-6}$ -alkyl,

heteroaryl, and

heteroaryl substituted by 1-4 substituents individually selected from cyano, cyano- $C_{1-6}$ -alkyl, halogen, halogen- $C_{1-6}$ -alkoxy, halogen- $C_{1-6}$ -alkyl,  $C_{1-6}$ -alkoxy,  $C_{1-6}$ -alkoxy- $C_{1-6}$ -alkyl,  $C_{2-6}$ -alkynyl- $C_{1-6}$ -alkoxy,  $C_{2-6}$ -alkynyl and  $C_{1-6}$ -alkyl;

$R^2$  is selected from the group consisting of

i) hydrogen,

$C_{1-6}$ -alkyl, and

halogen;

$R^3$  is selected from the group consisting of  $C_{1-6}$ -alkyl, and

halogen- $C_{1-6}$ -alkyl,

$R^4$  is halogen- $C_{1-6}$ -alkyl.

40/2013

Regeneron Pharmaceuticals, Inc., U.S.A.—“STABILIZED FORMULATION CONTAINING ANTI-ANG2 ANTIBODY”.

A61K39/395, A61K47/18, A61K47/26, A61K9/00, B65D85/00, A61J1/06 & C07D16/22.

143293

The present invention provides pharmaceutical formulations comprising an antibody that specifically binds to angiopoietin 2 (Ang-2). The formulations may contain, in addition to an anti-Ang-2 antibody, at least one amino acid, at least one sugar, or at least one non-ionic surfactant. The pharmaceutical formulations of the present invention exhibit a substantial degree of antibody stability after storage for several months and after being subjected to thermal and other physical stress.

112/2013

ELI LILLY AND COMPANY and Deciphera Pharmaceuticals, LLC, U.S.A.—“1-(3,3-DIMETHYLBUTYL)-3-(2-FLUORO-4-METHYL-5-(7-METHYL-2-(METHYLAMINO)PYRIDO[2,3-D]PYRIMIDIN-6-YL)PHENYL)UREA AND PHARMACEUTICAL COMPOSITION THEREOF”.

A01N43/42.

143294

143296

The present invention is directed to a compound which is 1-(3,3-dimethylbutyl)-3-(2-fluoro-4-methyl-5-(7-methyl-2-(methylamino)pyrido [2,3 -d]pyrimidin-6-yl)phenyl)urea and its crystalline form characterized by a X-ray powder diffraction pattern having characteristic peaks, in  $2\theta \pm 0.2$  occurring at 16.0 and one or more of 6.9, 7.0, 18.2 and 23.2 and its pharmaceutical composition for use as Raf inhibitor in the treatment of cancer. There was a problem for a single Raf inhibitor to be active; against all isoforms of Raf proteins including A-Raf, B-Raf, C-Raf, and B-Raf V600E mutation; and against tumor cells with upstream pathway activation by N-Ras mutations, K-Ras mutations, and cKit mutations. Accordingly, the present invention provides such a Raf inhibitor which may be active in inhibiting all isoforms of Raf proteins as well as active against tumor cells with upstream pathway activation by N-Ras mutations, K-Ras mutations, and cKit mutations.

87/2014

A preparation of antibiotic medicated mouthwash for combating gum diseases [after a certain dental procedure (scaling and root planning)]comprising: doxycycline hyclate ( $C_{22}H_{24}N_2O_8$ ); clobetasol propionate ( $C_{25}H_{32}ClFO_5$ ); lidocaine ( $C_{14}H_{22}N_2O$ ); diphenhydramine ( $C_{17}H_{21}NO$ ); xanthan gum ( $C_{35}H_{49}O_{29}$ ); aspartame ( $C_{14}H_{18}N_2O_5$ ); sodium saccharine ( $C_7H_4NNaO_3S$ ); sorbitol ( $C_6H_{14}O_6$ ); methyl paraben (mp) ( $CH_3(C_6H_4(OH)COO$ ); propyl paraben (pp) ( $C_{10}H_{12}O_3$ ); sodium meta bisulphite ( $Na_2S_2O_5$  or  $Na_2O_5S_2$ ); Glycerine ( $C_3H_8O_3$  or  $CH_2OH-CHOH-CH_2OH$ ); sodium lauryl sulphate (sls) ( $C_{12}H_{25}O_4S.Na$  or  $C_{12}H_{25}NaO_4S$ ); propylene glycol (pg) ( $C_3H_3O_2$  or  $CH_3CHOHCH_2OH$ );peppermint ( $C_6H_{10}O_7$ ); and deionized water.

M/s. Kanzo AG, Pakistan.—“Emulsifiable Composition of Water-Insoluble Herbicide from Pendimethalin and Metolachlor and process of Preparation thereof”.

532/2013

Roche Glycart AG., Switzerland.—“Interleukin-2 fusion protein” .

143297

C07K14/55, C12N15/62, A61K38/20, A61K51/10 & A61K47/48.

143295

A fusion protein comprising (i) a human IgG1-subclass immunoglobulin molecule comprising a modification reducing binding affinity of the immunoglobulin molecule to an Fc receptor as compared to a corresponding immunoglobulin molecule without said modification, and (ii) two interleukin-2 (IL-2) molecules; wherein said immunoglobulin molecule comprises the heavy chain variable region sequence of SEQ ID NO: 9 and the light chain variable region sequence of SEQ ID NO: 11; and wherein said immunoglobulin molecule comprises the amino acid substitutions L234A, L235A and P329G (EU numbering) in the immunoglobulin heavy chains.

The invention described herein relates to emulsifiable concentrate formulation of herbicides and preparation process thereof. Particularly, the emulsifiable concentrate formulation in the embodiment of present invention comprises of a mixture of two herbicides, pendimethalin and metolachlor with dispersants and an organic solvent. The said formulation is water-emulsifiable and storage stable at elevated temperatures. The emulsifiable concentrate formulations in the embodiment of present invention are prepared by mixing appropriate quantities of active ingredients, pendimethalin and metolachlor with a non-ionic and an anionic surfactant in an organic solvent. The formulation is stable and forms a homogenous emulsion when diluted with water.

125/2014

ELI LILLY AND COMPANY, U.S.A.—“COMPOUND 5,6-DIHYDRO-8H-IMIDAZO [2,1-C] [1,4]OXAZIN-6-YLMETHYL 2-(2,3-DIHYDRO-1H-INDEN-2-YLAMINO)-5,7-DIHYDRO-6H-PYRROLO [3,4 D]PYRIMIDINE-6-CARBOXYLATE AND PHARMACEUTICAL COMPOSITION THEREOF”

813/2013

Dr. Kefi Iqbal, Chairman & Head; Dr. Muhammad Usman, CEO and Dr. Muhammad Sleem Qazi, SSO, Pakistan.—“A preparation of antibiotic medicated mouthwash for combating gum diseases and process for preparation thereof”

A61Q11/00.

C07D471/02, C07D491/02 &amp; C07D487/02.

143298

143300

The present invention provides a compound of the formula I

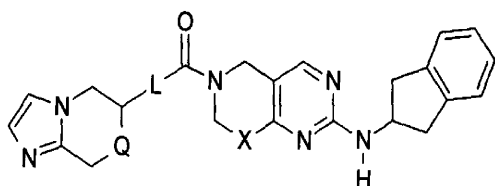

I

wherein

X is a bond;

Q is CH<sub>2</sub> or O;

L is selected from the group consisting of —OCH<sub>2</sub>— and —CH<sub>2</sub>O—.

The present invention further provides a pharmaceutical composition comprising said compound along with one or more pharmaceutically acceptable carrier, diluent, or excipient. The compound of present invention is autotaxin inhibitor and useful in treating pain associated with osteoarthritis.

151/2014 IRM LLC, Bermuda.—“NEW PROTEASE RESISTANT POLYPEPTIDE AND PHARMACEUTICAL COMPOSITION THEREOF”

A61K38/00, A61K38/17 & A61K38/16.

143299

The present invention relates to an isolated polypeptide comprising an amino acid sequence that has at least 95% amino acid sequence identity to an amino acid sequence selected from the group of sequences of TABLE 1, wherein the polypeptide comprises an amino acid that is a polar amino acid other than K or R at position 423, as determined with reference to SEQ ID NO: 1, and wherein the polypeptide has chondrogenic activity.

The present invention further provides a pharmaceutical composition comprising above said polypeptide, optionally with one or more additional components, for treating, ameliorating or preventing arthritis or joint damage.

297/2014 SICPA HOLDING SA, Switzerland.—“SINGLE USE VALVE FOR EXTRACTION OF INK FROM A SECURITY INK CONTAINER”.

F16K1/30, F16K35/02, F17C7/02 & B41J2/17.

A single use valve structured to allow only one fluid or gas or powder filling or extraction operation of a container such that neither a subsequent refilling nor a subsequent extraction operation can be performed. The single use valve may be used for extraction of ink from, or filling of ink to, a security ink container.

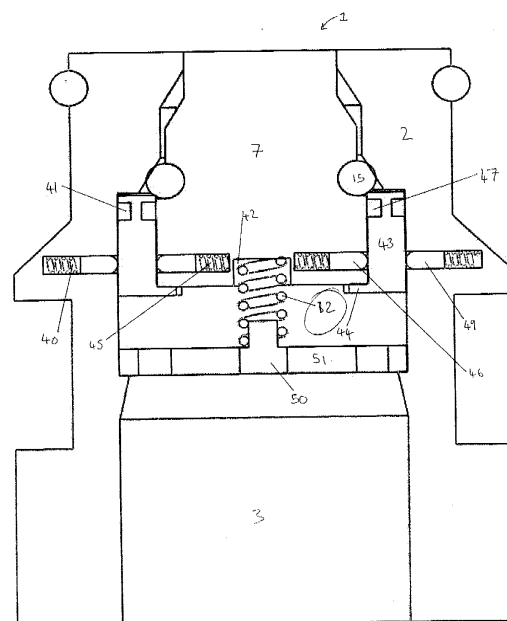

453/2014 NUC ELECTRONICS CO., LTD. and KIM, Ji Tae. Rep. of Korea.—“JUICE EXTRACTION MODULE FOR JUICER”.

A23N1/02

143301

Disclosed is a juice extraction module for a juicer, which includes a container formed with a juice discharge port; a sieve positioned inside of the container; a screw positioned inside of the sieve to extract juice from a material; a lid coupled to a top end of the container and formed with an input portion through which the material is input; and a safety cover rotatable installed to a main input opening of a top end of the input portion to be movable between a first position and a second position. The safety cover includes a first cover portion erected to open the main input opening in the first position and closing the main input opening in the second position; and a second cover portion formed integrally with the first cover portion, the second cover portion moving the safety cover to the second position when the second cover portion is pushed by a downward applied force from the first position, whereby the first cover portion blocks the main input opening.

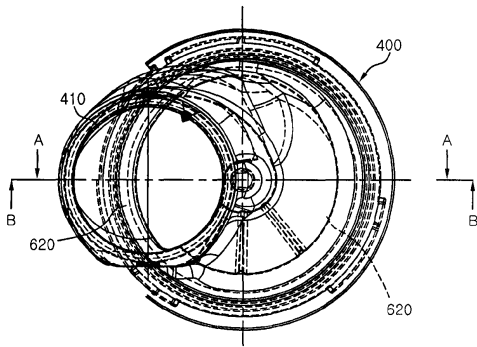

560/2014 Galapagos NV., Belgium.—“NOVEL TETRAMETHYLTHIENOPYRAN-CARBOXAMIDE AND PHARMACEUTICAL COMPOSITIONS THEREOF FOR THE TREATMENT OF CYSTIC FIBROSIS”.

C07D495/04 & A61K31/38.

143302

The present invention provides a novel compound of formula I:

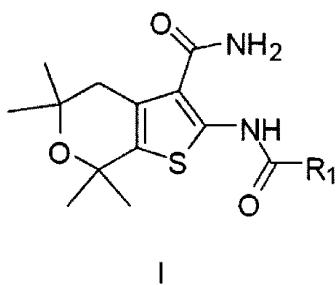

Wherein  $R_1$  is as defined in claims of the specification.

The present invention further provides a pharmaceutical composition comprising above said compound and pharmaceutically acceptable carrier which is therapeutically effective to treat cystic fibrosis.

699/2014 F. HOFFMANN-LA ROCHE AG, Switzerland.—“DIAZACARBAZOLE COMPOUND AS TAU-PET-LIGAND”

C07D 471/04, A61K31/44 & A61P25/28.

143303

The present invention relates to a compound of general formula

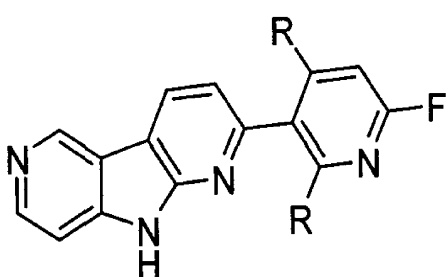

225/2015

wherein

R is hydrogen or tritium;

F is fluoro or  $^{18}\text{F}$ fluoro.

A compound of formula I include 2-(6-fluoropyridin-3-yl)-9H-dipyrido[2,3-b;3',4'-d]pyrrole, 3H-2-(6-fluoropyridin-3-yl)-9H-dipyrido[2,3-b;3',4'-d]pyrrole and  $[^{18}\text{F}]$ -2-(6-fluoropyridin-3-yl)-9H-dipyrido[2,3-b;3',4'-d]pyrrole.

The compound may be used for binding and imaging tau aggregates and related beta-sheet aggregates including besides others beta-amyloid aggregates or alpha-synuclein aggregates.

833/2014

Novartis AG, Switzerland.—“NOVEL AMINO PYRIMIDINE COMPOUND AND PHARMACEUTICAL COMPOSITION THEREOF”.

C07D239/47, C07D401/10, C07D405/12, C07D401/14, C07D403/12 & C07D401/12.

143304

The present invention relates to a compound of formula (I);

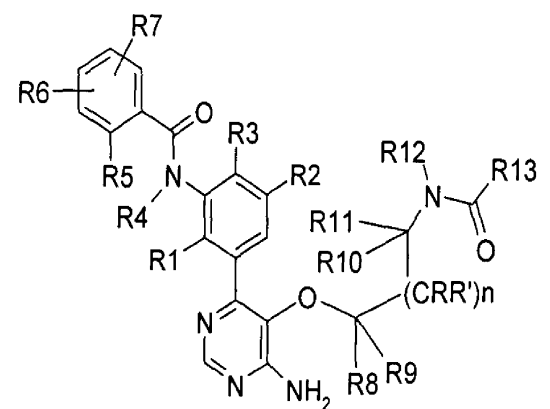

Wherein  $R_1$  to  $R_{13}$  are as defined in the claims of the specification.

The present invention further provides a pharmaceutical composition comprising a claimed compound and one or more pharmaceutically acceptable carriers. The compound of present invention is a selective inhibitor of Bruton's tyrosine kinase (Btk) and effective to treat the associated diseases such as autoimmune disorders, inflammatory diseases, allergic diseases, airway diseases, such as asthma and chronic obstructive pulmonary disease (COPD), transplant rejection, cancers e.g. of hematopoietic origin or solid tumors.

CHT R.Beitlich GmbH, Germany.—“PROCESS FOR BRIGHTENING DYED TEXTILES”.

D06L4/15 & D06L3/02.



	<p style="text-align: right;">143305</p> <p>The invention relates to a process for brightening dyed textiles and to the textiles thereby produced. The process is characterized by treating the materials with aqueous liquor containing an aliphatic or aromatic organic peroxocarboxylic acid with a hydrophobic radical, especially alkyl radical or aryl radical, consisting of at least 5 carbon atoms as an active component and the surprising effects found when more preferably material treating with 5 to 30 carbon atoms and even more preferably with chain lengths of from 6 to 10 carbon atoms have a very high brightening effect on dyed textiles.</p>	<p>one additional Fab fragment, wherein the additional Fab fragment is fused to the C-terminus of one of the heavy chains of the antibody, wherein the binding site of the additional Fab fragment specifically binds to a second antigen,</p> <p>wherein each of the antibody light chains comprises in the constant light chain domain (CL) at position 123 the amino acid residue arginine (instead of the wild-type glutamic acid residue; E123R mutation) and at position 124 the amino acid residue lysine (instead of the wild-type glutamine residue; Q124K mutation) (numbering according to Kabat),</p> <p>wherein each of the antibody heavy chains comprises in the first constant heavy chain domain (CH1) at position 147 an glutamic acid residue (instead of the wild-type lysine residue; K147E mutation) and at position 213 an glutamic acid residue (instead of the wild-type lysine amino acid residue; K213E mutation) (numbering according to Kabat EU index),</p> <p>wherein the additional Fab fragment specifically binding to the second antigen comprises a domain crossover such that the constant light chain domain (CL) and the constant heavy chain domain 1 (CH1) are replaced by each other, and</p> <p>wherein the first antigen is human CD20 protein and the second antigen is human transferrin receptor.</p>
<p>655/2015</p>	<p>ELI LILLY AND COMPANY and Deciphera Pharmaceuticals, LLC, U.S.A.—“A PHARMACEUTICALLY ACCEPTABLE SALT OF THE COMPOUND 1-(3,3-DIMETHYLBUTYL)-3-(2-FLUORO-4-METHYL-5-(7-METHYL-2-(METHYLAMINO)PYRIDO[2,3-D]PYRIMIDIN-6-YL)PHENYL)UREA AND PHARMACEUTICAL COMPOSITION THEREOF”.</p> <p>A01N43/42</p>	<p>wherein the additional Fab fragment specifically binding to the second antigen comprises a domain crossover such that the constant light chain domain (CL) and the constant heavy chain domain 1 (CH1) are replaced by each other, and</p> <p>wherein the first antigen is human CD20 protein and the second antigen is human transferrin receptor.</p>
	<p style="text-align: right;">143306</p> <p>The present invention is directed to a pharmaceutically acceptable salt of the compound which is 1-(3,3-dimethylbutyl)-3-(2-fluoro-4-methyl-5-(7-methyl-2-(methylamino)pyrido [2,3-d]pyrimidin-6-yl)phenyl)urea. The present invention further provides a pharmaceutical composition for use as Raf inhibitor in the treatment of cancer. There was a problem for a single Raf inhibitor to be active; against all isoforms of Raf proteins including A-Raf, B-Raf, C-Raf, and B-Raf V600E mutation; and against tumor cells with upstream pathway activation by N-Ras mutations, K-Ras mutations, and cKit mutations. Accordingly, the present invention provides such a Raf inhibitor which may be active in inhibiting all isoforms of Raf proteins as well as active against tumor cells with upstream pathway activation by N-Ras mutations, K-Ras mutations, and cKit mutations.</p>	<p>591/2016</p> <p>F. HOFFMANN-LA ROCHE AG, Switzerland.—“BISPECIFIC ANTI-HUMAN A-BETA/HUMAN TRANSFERRIN RECEPTOR ANTIBODY”.</p> <p>C07K16/28 &amp; C07K16/18.</p> <p style="text-align: right;">143308</p> <p>Herein are provided bispecific anti-human A-beta/human transferrin receptor antibody comprising</p> <p>one antibody comprising two pairs each of a antibody light chain and a antibody heavy chain, wherein the binding sites formed by each of the pairs of the heavy chain and the light chain specifically bind to a first antigen, and</p> <p>one additional Fab fragment, wherein the additional Fab fragment is fused to the C-terminus of one of the heavy chains of the antibody, wherein the binding site of the additional Fab fragment specifically binds to a second antigen,</p> <p>wherein each of the antibody light chains comprises in the constant light chain domain (CL) at position 123 the amino acid residue arginine (instead of the wild-type glutamic acid residue; E123R mutation) and at position 124 the amino acid residue lysine (instead of the wild-type glutamine residue; Q124K mutation) (numbering according to Kabat),</p>
<p>590/2016</p>	<p>F. HOFFMANN-LA ROCHE AG, Switzerland.—“BISPECIFIC ANTI-HUMAN CD20/HUMAN TRANSFERRIN RECEPTOR ANTIBODY”.</p> <p>C07K16/28.</p>	<p>one additional Fab fragment, wherein the additional Fab fragment is fused to the C-terminus of one of the heavy chains of the antibody, wherein the binding site of the additional Fab fragment specifically binds to a second antigen,</p> <p>wherein each of the antibody light chains comprises in the constant light chain domain (CL) at position 123 the amino acid residue arginine (instead of the wild-type glutamic acid residue; E123R mutation) and at position 124 the amino acid residue lysine (instead of the wild-type glutamine residue; Q124K mutation) (numbering according to Kabat),</p>
	<p style="text-align: right;">143307</p> <p>A bispecific antibody comprising one antibody comprising two pairs each of a antibody light chain and a antibody heavy chain, wherein the binding sites formed by each of the pairs of the heavy chain and the light chain specifically bind to a first antigen, and</p>	<p>wherein the additional Fab fragment specifically binds to a second antigen,</p> <p>wherein each of the antibody light chains comprises in the constant light chain domain (CL) at position 123 the amino acid residue arginine (instead of the wild-type glutamic acid residue; E123R mutation) and at position 124 the amino acid residue lysine (instead of the wild-type glutamine residue; Q124K mutation) (numbering according to Kabat),</p>

wherein each of the antibody heavy chains comprises in the first constant heavy chain domain (CH1) at position 147 an glutamic acid residue (instead of the wild-type lysine residue; K147E mutation) and at position 213 an glutamic acid residue (instead of the wild-type lysine amino acid residue; K213E mutation) (numbering according to Kabat EU index),

wherein the additional Fab fragment specifically binding to the second antigen comprises a domain crossover such that the constant light chain domain (CL) and the constant heavy chain domain 1 (CH1) are replaced by each other, and

wherein the first antigen is human A-beta protein and the second antigen is human transferrin receptor.

820/2016 MERCK SHARP & DOHME CORP, U.S.A.—  
“FUSED TRICYCLIC HETEROCYCLIC COMPOUND”.

C07D487/16, C07D471/16, A61K31/5025 & A61P31/18.

143309

The present invention relates to Fused Tricyclic Heterocyclic Compound of Formula (I):

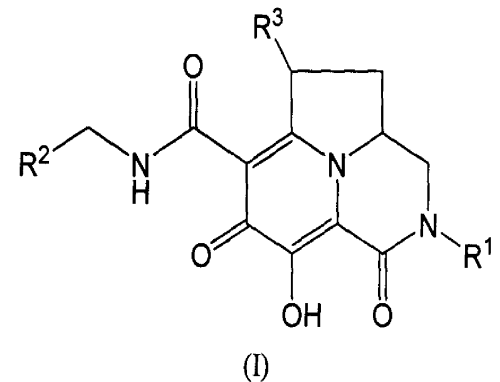

wherein R<sup>1</sup>, R<sup>2</sup> and R<sup>3</sup> are as defined herein. The present invention also relates to composition comprising at least one Fused Tricyclic Heterocyclic Compound.

#### NEW APPLICATIONS FOR THE INDUSTRIAL DESIGNS

Design No.	Title & Class	Applicant
<b>23rd September, 2019</b>		
20080	Ornamantation (Class-12)	MUHAMMAD IQBAL S/O. GHULAM HUSSAIN
20081	Ankle Cross Shaft of a Humanoid Robot (Class-01)	Muhammad Hamza Asif Nizami, Zaid Ahsan Shah, Yaser Ayaz and Mashhood Asad Butt
20082	Knee Double Bearing of a Humanoid Robot (Class-01)	Muhammad Hamza Asif Nizami, Zaid Ahsan Shah, Yaser Ayaz and Mashhood Asad Butt
20083	Actuator of Exoskeleton Hand (Class-03)	Muhammad Hamza Asif Nizami, Abdul Rehman, Hamza Butt, Muhammad Hamza Javed, Yasar Ayaz and Muhammad Jawad Khan
20084	Kinematic Chain of Exoskeleton Hand (Class-03)	Muhammad Hamza Asif Nizami, Abdul Rehman, Hamza Butt, Muhammad Hamza Javed, Yasar Ayaz and Muhammad Jawad Khan
20085	Sixth Finger Actuator (Class-03)	Muhammad Hamza Asif Nizami, Fahad Imtiaz Bhatti, Ibrahim Bin Yasir, Muhammad Umer Khan Niaz, Yasar Ayaz and Muhammad Jawad Khan
20086	Passive Adaptive Ankle Mechanism of a Humanoid Robot	Muhammad Hamza Asif Nizami, Zaid Ahsan Shah, Yaser Ayaz and Mashhood Asad Butt

Design No.	Title & Class	Applicant
20087	Brain Imaging Tools for Medical Diagonosis (Class-03)	Muhammad Hamza Asif Nizami, Umer Asghar, Sara Ali, Yasir Ayaz and Muhammad Jawad Khan
20088	Sixth Finger Support (Class-03)	Muhammad Hamza Asif Nizami, Fahad Imtiaz Bhatti, Ibrahim Bin Yasir, Muhammad Umer Khan Niazi, Yasar Ayaz and Muhammad Jawad Khan
20089	A low cost wearable exoskeleton suit for weight handling (Class-01)	Muhammad Hamza Asif Nizami, Faizan Ahmed, Yasar Ayaz, Sara Ali and Muhammad Jawad Khan
<b>24th September, 2019</b>		
20090	MOTORCYCLE (Class-Nil)	HONDA MOTOR CO., LTD.
20091	Football (Class-06)	M/s. Madrigal Sports (Pvt) Ltd.,
20092	Football (Class-06)	M/s . Madrigal Sports (Pvt) Ltd.,
<b>26th September, 2019</b>		
20093	Electric Bike (Class-12)	MBI Co., Ltd.
20094	Electric Bike (Class-12)	MBI Co., Ltd.
20095	Electric Bike (Class-12)	MBI Co., Ltd.
20096	Solar Panels for its cleaning (Class-03)	Nasir Rashid, Umar Shahbaz Khan, Ubaid ur Rehman, Mudassir Maqsood Khan, Hafsa Ahmed and Muhammad Saifullah
<b>27th September, 2019</b>		
20097	AUTOMOBILE (Class-01)	TOYOTA JIDOSHA KABUSHIKI KAISHA

**REGISTRATION OF DESIGNS**

The following designs have been registered.

S. No.	Design No.	Title & Class	Applicant
<b>23rd September, 2019</b>			
1.	14452	BOTTLE (Class-03)	Bayer Aktiengesellschaft

**NEW APPLICATIONS FOR THE PATENTS**

661/2019 ELI LILLY AND COMPANY, U.S.A. (Priority 15th October, 2018, US).—"KRAS G12C INHIBITORS".

The dates shown in the crescent brackets are the dates claimed under section 86 of the Patents Ordinance 2000.

**30th September, 2019**

651/2019 Syngenta Participations AG, Switzerland (Priority 2nd October, 2018, EP).—"PESTICIDALLY ACTIVE BENZENE- AND AZINE-AMIDE COMPOUNDS".

**1st October, 2019**

652/2019 SANOFI, U.S.A. (Priority 1st October, 2018, US).—"UDP GLYCOSYLTRANSFERASE INHIBITORS AND METHOD OF USE".

653/2019 SEECHEM HORIZON SDN. BHD, Malaysia (Priority 22nd March, 2019, MY).—"A METHOD OF ENHANCING PRODUCTION AND TRANSPORTATION OF HEAVY CRUDE OIL".

654/2019 SEECHEM HORIZON SDN. BHD, Malaysia (Priority 5th April, 2019, MY).—"METHOD FOR ENHANCED OIL RECOVERY USING AN EMULSION".

655/2019 SEECHEM HORIZON SDN. BHD, Malaysia (Priority 29th January, 2019, MY).—"METHOD FOR RECOVERING HYDROCARBONS FROM WASTE SLUDGE".

656/2019 SEECHEM HORIZON SDN. BHD, Malaysia (Priority 22nd March, 2019, MY).—"AN IN-SITU PROCESS FOR CLEANING A GAS PROCESSING PLANT".

657/2019 Dr. Naheed Kausar and Mr. Umair Ihsan, Pakistan.—"A PROCESS FOR UTILIZING BOTTOM ASH OF A THERMAL POWER PLANT TO PREPARE LIQUID SODIUM SILICATES OF REQUIRED STRENGTH".

658/2019 Graf + Cie AG, Switzerland (Priority 4th October, 2018, CH).—"Circular comb for a combing machine".

659/2019 Graf + Cie AG, Switzerland (Priority 4th October, 2018, CH).—"Circular comb for a combing machine".

**2nd October, 2019**

660/2019 Wei-Min Wu and Cheng-Chung CHIU, Taiwan (Priority 4th October, 2018, TW).—"INTERMITTENT BRAKE ASSISTING DEVICE".

**3rd October, 2019**

662/2019 Mujtaba Ellahim Department of Chemistry, Faculty of Arts & Basic Sciences, Muhammad Aslam Bhutta, Muhammad Naeem Shahwani, Department of Biotechnology; Jan Muhammad, Department of Computer Science, Hamid Ullah, Department of Chemistry, Faculty of Arts & Basic Sciences, and Zahoor Ullah, Department of Chemistry, Faculty of Arts & Basic Sciences., Pakistan.—"Preparation of Silver nano particles (AgNPs) doped epoxy based thin PDLC films (Smart Glass)".

663/2019 PFIZER INC., U.S.A. (Priority 5th October, 2018, US).—"BORON CONTAINING PDE4 INHIBITORS".

664/2019 PFIZER INC., U.S.A. (Priority 6th June, 2016, US).—"Substituted Carbonucleoside Salt Useful as Anticancer Agent".

665/2019 TerViva Bioenergy, Inc., U.S.A. (Priority 4th October, 2018, US).—"PONGAMIA COMPOSITIONS, METHODS OF PREPARING AND ANALYZING THEREOF, AND USES THEREOF".

666/2019 Dr. Faisal Ahmed Khan Kakar and Mr. Rozi Khan, Pakistan.—"Mineralizer: A software using convolutional neural networks for mineral identification".

**4th October, 2019**

667/2019 UNILEVER PLC, United Kingdom (Priority 15th October, 2018, CN).—"A Cosmetic Composition".

668/2019 Novo Nordisk A/S, Denmark (Priority 5th October, 2018, EP).—"BIFUNCTIONAL COMPOUNDS COMPRISING INSULIN PEPTIDES AND EGF(A) PEPTIDES".

**SEALING FEES DUE-**

Notice is hereby given that the Patent may now be sealed on the application referred to below if it is desired that Patent should be sealed a request on the prescribed Form-10 accompanied by the fee of Rs.4500/- should be sent to the Controller of Patents and Designs, The Patent Office, Karachi.

Accepted No.	Applicant Name	Application No.
143154	Novartis AG., Switzerland	476/2001
143155	Novartis AG., Switzerland	698/2006
143156	PLEXXIKON INC., U.S.A.	1328/2007
143157	H. LUNDBECK A/S, Denmark	1042/2010
143158	H. LUNDBECK A/S, Denmark	1043/2010
143159	Shahid Rahman S/o. Khan Bahadur Abdur Rehman Khan. Pakistan	59/2012
143160	Stora Enso Oyj (Finn Company), Finland	551/2013
143161	UPL Limited, India	706/2013
143162	PFIZER INC., U.S.A.	896/2013
143163	Galapagos NV., Belgium	186/2014
143164	SYNGENTA LIMITED and Syngenta Participations AG, Great Britain.	753/2014
143165	PFIZER INC., U.S.A.	738/2015
143166	PLEXXIKON, INC., U.S.A.	16/2018
143167	FB Genetics (Pvt.) Ltd., Pakistan.	334/2018

**NEW APPLICATIONS FOR THE INDUSTRIAL DESIGNS**

Design No.	Title & Class	Applicant
<b>1st October, 2019</b>		
20098	BOTTLE (Class-03)	M/s. Qarshi Brands (SMC) (Pvt.) Ltd.
20099	SURGICAL, DENTAL ELEVATOR HANDLE (Class-01)	M/S. DENTART INSTRUMENTS CO., SOLE PROPRIETORSHIP MANUFACTURES & EXPORTERS OF SURGICAL, DENTAL & MEDICAL INSTRUMENTS
<b>4th October, 2019</b>		
20100	Manhole Cover (Class-03)	Abdul Sattar,

**REGISTRATION OF DESIGNS**

The following designs have been registered.

S. No.	Design No.	Title & Class	Applicant
<b>1st October, 2019</b>			
1.	17702	Joint Less Tweezers/Forceps With Straight Points (Class-01)	M/s. Zona Industries
2.	19199	Extracting Forcep & Plies Handle (Class-01)	Mobeen Khan Lodhi
3.	19063	Register a CANE new and original design for use and marketing of lubricants (Class-03)	AHMED ALI TAHIR, ITTEHAD LUBRICANTS
<b>2nd October, 2019</b>			
4.	19149	ERASER (Class-03)	NAZIA NAVEED
5.	19145	FOUNTAIN PEN (Class-03)	NAZIA NAVEED
6.	19142	ERASER (Class-03)	NAZIA NAVEED
7.	19143	ERASER (Class-03)	NAZIA NAVEED
8.	19144	SCALE (Class-03)	NAZIA NAVEED
9.	19141	PENCIL SHARPENER (Class-03)	NAZIA NAVEED
10.	19146	ERASER (Class-03)	NAZIA NAVEED
11.	18758	Body of ceiling fan (Class-01)	Ningbo Woshida Electrical Appliances Technology Co., Ltd.
12.	19148	FOUNTAIN PEN (Class-03)	NAZIA NAVEED
13.	19147	PENCIL SHARPENER (Class-03)	NAZIA NAVEED
14.	19140	SCALE (Class-03)	NAZIA NAVEED

DR. MUHAMMAD FAYYAZ AHMAD,  
Controller of Patents & Registrar of Designs.