



The Gazette of Pakistan

PUBLISHED BY AUTHORITY

No. 17]

KARACHI, WEDNESDAY, APRIL 28, 2021

C O N T E N T S

	PAGES		PAGES
PART I — Notifications regarding appointments, promotions, etc., issued by Ministries/Divisions of the Government of Pakistan, Department of the Auditor-General of Pakistan and the Supreme Court of Pakistan other than the Ministry of Defence and Ministry of Defence Production	459—494	PART IV — Notifications issued by the minor administrations and miscellaneous notification not included in any other part	39—41
PART II — Notifications issued by the Ministry of Defence and Ministry of Defence Production	111—120	PART V — Notifications etc., issued by The Patent Office.	113—118
PART III — Notifications issued by the High Courts, the Federal Public Service Commission and by the Attached and Subordinate Offices of the Government of Pakistan	249—260	PART VI — Advertisements and Notices issued by Corporate Bodies and Private Individuals on payment.....	135—136
		SUPPLEMENT NO.	
		Weekly, notification of cases and deaths from quarantiable diseases	

PART I

Notifications regarding appointments, promotions, etc. issued by Ministries/Divisions of the Government of Pakistan, Department of the Auditor-General of Pakistan and the Supreme Court of Pakistan other than the Ministry of Defence and Ministry of Defence Production

PRIME MINISTER'S OFFICE (PUBLIC)

Islamabad, the 26th March, 2021

No. F. 3(3)/2021-Admn.—In pursuance of Establishment Division's Notification No. 1-28/2012-E-2, dated 16th March, 2021, Mr. Naeem Iqbal, a BS-19 officer of Secretariat Group, has assumed the charge of the post of Deputy Secretary (BS-19), in the Prime Ministry's office (Public), with effect from 18th March, 2021.

HAIDER MUNAWAR CHEEMA,
Section Officer (Admn).

[BOARD OF INVESTMENT]

Islamabad, the 26th March, 2021

No. 1(1)/2019-PRMI-BOI.—The Steering Committee to oversee the Implementation of Pakistan Regulatory Modernization Initiative (PRMI) notified *vide* BOI's Notifications, *i.e.* No. 5(2)PRMI/EoDB/2019 dated 20th August 2019, 17th September, 2020, 30th September,

2020, 19th October, 2020 and is hereby re-constituted (with inclusion of Secretary, Ministry of Industries & Production and Chief Commissioner, ICT, Islamabad as members) as per decision of PRMI Progress Review meeting held on 24th March, 2021 under the Chairmanship of Adviser to PM on Commerce and Investment, as under :-

- | | |
|--|----------------------|
| 1. Mr. Abdul Razak Dawood,
Adviser to PM on Commerce &
Investment. | Chair |
| 2. Adviser to PM on Institutional Reforms. | Member |
| 3. Chairman, Board of Investment. | Member |
| 4. Chairman, Federal Board of Revenue. | Member |
| 5. Secretary, Board of Investment. | Member/
Secretary |
| 6. Secretary, Commerce. | Member |
| 7. Secretary, Ministry of Industries &
Production. | Member |

(459)

- | | | | |
|-----|---|---------|--|
| 8. | Chief Secretaries of all Provinces/
Regions. | Member | (LFP) on medical grounds with effect from 10th February, 2021 to 26th February, 2021 in respect of Ms. Maryam Mannan, Deputy Director (BPS-18) NAB Rawalpindi. |
| 9. | Chief Commissioner, ICT
Administration. | Member | On the expiry of leave, the officer will resume her duty of the same post at the same station. |
| 10. | President, Federation of Pakistan
Chambers of Commerce & Industry
(FPCCI). | Member | No. 1(543)/Admn/2013/3958. —Director General NAB (R) / Islamabad has been pleased to grant 19 days Quarantine leave with effect from 29th December, 2020 to 16th January, 2021 & 9 days LFP on medical grounds with effect from 17th January, 2021 to 25th January, 2021 in respect of Mr. Umair Naeem Bajwa, Assistant Director (BPS-17), NAB (R) Sub Office Gilgit. |
| 11. | CEO, The Pakistan Business Council
(PBC). | Member | |
| 12. | CE/SG, Overseas Investors Chambers
of Commerce & Industry (OICCI). | Mmeber | |
| 13. | Presidents of Karachi, Lahore and
Faisalabad Chambers of Commerce
& Industry. | Members | On the expiry of leave, the officer has resume his duties of the same post at the same station. |
| 14. | Mr. Almas Hyder, former President,
Lahore Chamber of Commerce &
Industry. | Member | No. 1(751)/Admn/2017/3957. —Director General NAB (R) / Islamabad has been pleased to grant 22 days Quarantine leave with effect from 7th January, 2021 to 28th January, 2021 & 4 days LFP on medical grounds with effect from 29th January, 2021 to 1st February, 2021 in respect of Mr. Asadullah Makhdoom, Dy. Assistant Director (BPS-16), NAB (R), Sub Office Gilgit. |
| 15. | Any other member coopted by the chair | | |

MAHMOOD TUFAIL,
Director-PRMI.

On the expiry of leave, the officer has resume his duty of the same post at the same station

Islamabad, the 24th March, 2021

No. 3(172)-HR/2016.—Mr. Shahzad Ahmed, Deputy Assistant Director (BS-16), Prime Minister's Office, Board of Investment, Islamabad is hereby granted ten (10) days leave on full pay (LFP) from 24th March, 2021 to 2nd April, 2021.

After expiry of leave, he is likely to resume his duty at the same post and station.

ABDUL SATTAR,
Deputy Director (HR).

ERIC PAUL,
Deputy Director (Admn).

Islamabad, the 25th February, 2021

No. 7-7(5)Inquiry/K/2020-PM-III.—In continuation of this Bureau's notification of even number dated 15th October, 2020 the suspension period of Mr. Faraz Ahmed, Private Secretary (BPS-18), National Accountability Bureau (Multan) is hereby extended for a further period of two (02) months with effect from 15th January, 2021.

This issues with the approval of the Competent Authority.

NATIONAL ACCOUNTABILITY BUREAU

Islamabad, the 25th February, 2021

No. F. 2(143)/HQ/2021/PM-I.—Competent Authority has been pleased to approve posting/transfer of Mr. Muhammad Rafi, Additional Director (BPS-19) from National Accountability Bureau (Lahore) to NAB (Karachi) with immediate effect and until further orders.

TA/DA and joining time will be admissible under the rules.

IMRAN SOHAIL,
Additional Director (PM).

No. 7-7(5)Inquiry/K/2020-PM-III.—In continuation of this Bureau's notification of even number dated 15th October, 2020 the suspension period of Mr. Muneer Ahmed, Assistant Private Secretary (BPS-16), National Accountability Bureau (Multan) is hereby extended for a further period of two (02) months with effect from 15th January, 2021.

This issues with the approval of the Competent Authority.

No. 7-7(5)Inquiry/K/2020-PM-III.—In continuation of this Bureau's notification of even number dated 15th October, 2020 the suspension period of Mr. Noman Iqbal, Assistant Private Secretary (BPS-16), National Accountability Bureau (KP), Peshawar is hereby extended for a further period of two (02) months with effect from 15th January, 2021.

This issues with the approval of the Competent Authority.

No. 1(399)/Admn/2013/3956.—Director General NAB (R) has been pleased to grant 17 days leave on full pay

LUBNA BASHIR,
Assistant Director (PM-II).

CABINET SECRETARIAT

Islamabad, the 5th March, 2021

(Cabinet Division)

Islamabad, the 5th March, 2021

No. PF. (272)/08-Admn(NDC).—Disciplinary proceeding against Mr. Muhammad Zia-ud-Din, Deputy Director-II, National Documentation Wing, Cabinet Division were initiated under the provision of the Government Servants (Efficiency & Discipline) Rules, 1973, on account of late submission of reports on observance and Implementation of Principles of Policy for the years 2013-14, 2014-15 and 2015-16. The postponement of the meeting of a Minister's Committee, constituted by the Prime Minister creating embarrassing position for the Cabinet Division.

2. Mr. Muhammad Zia-ud-Din, Deputy Director-II ND Wing, having been found inefficient, the Competent Authority *i.e.* Cabinet Secretary, on the recommendation of Authorized Officer, in terms of Rules 3 (a) of Government Servants (E&D) Rules, 1973, a minor penalty of "CENSURE" under Rule 4 (1) (a) (i) of Government Servants (E&D) Rules, 1973, has been imposed upon him, with the direction to conduct his duties in accordance with the Rules of Business and Secretariat instruction and ensure quick disposal of official business.

MUHAMMAD ZAHID SHAH,
Deputy Secretary (Admin).

Islamabad, the 2nd March, 2021

No. PF. (1173)-Admn-II.—Mr. Muhammad Sajid Iqbal, Private Secretary (BS-17), Cabinet Division, will stand retired from Government Service with effect from 3rd April, 2021 on attaining the age of superannuation (His date of birth is 3rd April, 1961).

The competent authority has been pleased to approve grant of leave encashment of 365 days to the officer in lieu of the whole period of LPR due and admissible in terms of Rule 18(A) of Revised Leave Rule, 1980, as amended.

This supersedes the Notification No. PF (2401)Admn-I, dated 19th August 2020.

Islamabad, the 3rd March, 2021

No. PF. (1169)-Admn-II.—In pursuance of Establishment Division's Notification No. F. 39/1094/2021/ E-I dated 26th February, 2021, Mr. Ghulam Mujtaba Joyo, a BS-20 officer of Secretariat Group, has assumed the charge of the post of Joint Secretary, Cabinet Division on regular basis, with effect from 1st March, 2021.

Islamabad, the 4th March, 2021

No. PF. (1176)-Admn-II.—In pursuance of Establishment Division's Notification No. F. 40/620/2019/ E-I dated 26th February, 2021, Mr. Abdul Sattar Khokhar, a BS-21 officer of Secretariat Group, has assumed the charge of the post of Additional Secretary (BS-21), Cabinet Division with effect from 1st March, 2021.

SARDAR MEHMOOD,
Section Officer (Admn-II).

No. 4/9/2015-RA-II/OGRA.—With the approval of the competent authority *i.e.* Cabinet Secretary, Mr. Noorul Haque, Member (Finance) Oil and Gas Regulatory Authority (OGRA), Islamabad under Cabinet Division is granted 61 days leave from the date of joining of the new Chairman, OGRA and subject to the condition of completing subsequent process of handing & taking over the charge to the incumbent Chairmen, OGRA as per entitlement and fulfillment/observance of all codal formalities relating to the smooth transition of charge & allied matters under the applicable rules/policy.

On expiry of leave, the officer is likely to assumed his duties as Member, Finance, OGRA on the same station.

This Division's notification of even number dated 24th February, 2021 is hereby cancelled/withdrawn, *ab-initio*.

SHAFQAT ALI CHACHAR,
Section Officer (RA-II).

Islamabad, the 3rd March, 2021

No. F. 1(103)/2018-ARU-Org-IV.—The Cabinet Secretary has been pleased to assign the additional charge of the post of Joint Secretary / Secretary, Assets Recovery Unit to Mr. Qamar Zaman, Joint Secretary / Secretary, Institutional Reforms Cell with immediate effect for a period of three months or until the joining of regular incumbent, whichever is earlier.

SYED ZAKI HASSAN NAQVI,
Section Officer.

(Aviation Division)

Islamabad, the 8th February, 2021

No. F. 1-11/2020-Admin.—Mr. Muhammad Arsalan Khan, Section Officer (AT-II) has been granted Additional Charge of the post of Section Officer (CAA) for a period of three (03) months with effect from 4th February, 2021 or till the posting of a regular Section Officer whichever is earlier.

This issues with the approval of Secretary Aviation Division.

SHEIKH NOOR MUHAMMAD,
Deputy Secretary (Admin.).

Islamabad, the 3rd February, 2021

No. F. 8(1)/2020-F.—In pursuance of decision made by ECC of the Cabinet in Case No. ECC-23/2/2021, dated

20th January, 2021 duly ratified by Federal Cabinet in its meeting held on 26th January, 2021, following Committee is constituted :-

- | | |
|--|----------|
| i. Deputy Chairman Planning Commission | Chairman |
| ii. Secretary Finance, | Member |
| iii. Secretary Aviation | Member |
| iv. Secretary Law & Justice Divisions | Member |

ToRs :-

1. PIA-IL will provide complete record of additional requirement supported by duly verified documents to the Committee for its examination/consideration;
2. The Committee shall also examine the propriety of the request for additional requirement of \$ 35.577 Million in the backdrop of BVI Court's decision in TCC's case;
3. Any other point as the Committee may deem appropriate; and
4. It shall formulate its recommendations and submit report in this context for the consideration of ECC of Cabinet within 15 days from the date of its constitution.

Note:- The Aviation Division shall provide the Secretariat support to the Committee.

Ms. SHAHIDA,
Section Officer (Flying).

(Establishment Division)

Islamabad, the 11th February, 2021

No. PF. 1546/2019-E-VII.—Ms. Iqra Irshad (OMG/BS-17/ Probationer), presently posted as Section Officer, Commerce Division is transferred and posted as Section Officer, Ports and Shipping Wing, Karachi under Maritime Affairs Division, with immediate effect and until further orders.

Islamabad, the 12th February, 2021

No. PF. 936/2009-E-VII.—Ms. Tahmina Habib (OMG/BS-18), OSD, Establishment Division is transferred and posted as Section Officer, Economic Affairs Division, with immediate effect and until further orders.

Islamabad, the 17th February, 2021

No. PF. 1295/2014-E-VII.—The leave period of Ms. Maria Asif Dar (OMG/BS-18), OSD, Establishment Division is extended for a further period of 90 days leave on full pay (on medical grounds) with effect from 2nd February, 2021, subject to title.

Islamabad, the 19th February, 2021

No. PF. 1278/2014-E-VII.—Mr. Masroor Hussain (OMG/BS-18), Section Officer, Establishment Division is transferred and his services are placed at the disposal of

Benazir Income Support Programme (BISP), on standard terms and conditions of deputation, for a period of three years, with immediate effect and until further orders.

No. F. 4/84/2013-E-VII.—Mr. Rashid Ahmad (BS-17/ Deputationist), presently posted as Section Officer, Interior Division is transferred and posted as Section Officer, States and Frontier Regions Division, as a replacement of Mr. Ubaid Ullah (OMG/BS-18), with immediate effect and until further orders.

Islamabad, the 22nd February, 2021

No. PF. 1320/2015-E-VII.—Mr. Mubeen Ahmed (OMG/BS-18), Section Officer, Housing and Works Division, presently availing "Master Degree in International Development Programme" from International University of Japan is directed to report to Establishment Division upon completion of his scholarship.

Islamabad, the 23rd February, 2021

No. PF. 1222/2013-E-VII.—Ms. Wajeeha Bashir (OMG/BS-18), Section Officer, National Food Security and Research Division, is transferred and her services are placed at the disposal of Financial Action Task Force (FATF), National FATF Secretariat, on standard terms and conditions of deputation, for a period of three years, with immediate effect and until further orders.

No. F. 1/11/2021-E-VII.—The following transfers/postings are made as mentioned against each of the OMG officer with immediate effect and until further orders :-

S. No.	Name of the Officers	From	To
1.	Mr. Azhar Nisar (OMG/BS-18)	Section Officer, Finance Division (Military)	Section Officer, Finance Division, as a replacement of Mr. Muhammad Qadeer.
2.	Mr. Muhammad Shahid (OMG/BS-18)		Section Officer, Finance Division, as a replacement of Ch. Saad Ghani.
3.	Hafiz Laeeq-Ur-Rehman (OMG/BS-18)		Section Officer, Finance Division, as a replacement of Ms. Anum Nasir.

No. F. 6/9/2010-E-VII.—The Competent Authority has been pleased to terminate the probation period of the following Section Officers (BS-17) of the Office Management Group :-

S. No.	Name of the officers
Officer belonging to 45th CTP	
1.	Ms. Maria Afzal
2.	Ms. Fahmeena Aslam
3.	Mr. Muhammad Awais Hashmi
4.	Hafiz Muhammad Usman Munawar
5.	Ms. Tahreen Akbar

Islamabad, the 25th February, 2021

No. PF. 944/2009-E-VII.—Mr. Muhammad Naeem Saleem (OMG/BS-18), awaiting posting, Establishment Division is transferred and posted as Officer on Special Duty (OSD) in Establishment Division with effect from 18th February, 2021 and granted 36 days leave on full pay (LFP) with effect from 18th February, 2021 to 25th March, 2021, subject to title.

No. F. 4/84/2013-E-VII.—Mr. Imran Hussain (OMG/BS-17/Probationer), presently posted as Section Officer, Kashmir Affairs and Gilgit-Baltistan Division is transferred and posted as Section Officer, Interior Division, as a replacement of Mr. Rashid Ahmad, with immediate effect and until further orders.

SHAMS-UD-DIN,
Section Officer.

Islamabad, the 22nd February, 2021

No. PF. (1500)/E-5(PAS).—Ms. Zainab Tahir, a BS-17 officer of Pakistan Administrative Service, presently posted under Government of Khyber Pukhtunkhawa, is transferred and her services are placed at the disposal of Government of the Punjab, with immediate effect and until further orders.

No. PF. (1491)/E-5(PAS).—Ms. Ayesha Khan, a BS-17 officer of Pakistan Administrative Service, presently posted under Government of Punjab, is transferred and her services are placed at the disposal of Government of Gilgit-Baltistan, with immediate effect and until further orders.

Islamabad, the 25th February, 2021

No. PF. (926)/E-5(PAS).—Mr. Jawad Akram, a BS-19 officer of Pakistan Administrative Service, presently serving in Civil Services Academy, Lahore is transferred and his services are placed at the disposal of Federal Education and Professional Training Division, on deputation basis, for a period of three years, on standard terms and conditions, with immediate effect and until further orders.

EJAZ AHMAD,
Section Officer.

[MANAGEMENT SERVICES WING]

Islamabad, the 11th February, 2021

No. 13/5/2017-Admn.—Mr. Muhammad Jawad, Assistant Private Secretary (BS-16), Management Services Wing, Establishment Division, Islamabad is granted 7 days extension in LFP on medical grounds from 11th February, 2021 to 17th February, 2021.

After expiry of leave, he is likely to resume his duty on the same post and station.

Islamabad, the 17th February, 2021

No. 13/9/2012-Admin.—Ms. Norina Bibi, Assistant Director (BS-17), Management Services Wing, Establishment Division, Islamabad presently posted in Federal Employees Benevolent and Group Insurance Funds (FEB&GIF), Karachi is promoted to the post of Deputy Director (BS-18).

Islamabad, the 18th February, 2021

No. 13/5/2016-Admn.—Mr. Tariq Faheem Sheikh, Director General (BS-20), Management Services Wing, Establishment Division, Islamabad will stand retired from Government Service on attaining the age of superannuation with effect from 18th April, 2021.

ASAD MEHMOOD KHAN,
Section Officer (Admn).

(Pakistan Public Administration Research Centre)

Islamabad, the 24th February, 2021

No. 1/7/2015-PPARC.—In pursuance of Establishment Division's Notification No. PF. 39/1034/2015-E-I, dated 9th February, 2021, Mr. Muhammad Lakhkar Khan Hoti, a BS-20 officer of Secretariat Group, has assumed the charge of the post of Director General (BS-20), in Pakistan Public Administration Research Centre, Establishment Division, Islamabad with effect from 22nd February, 2021.

2. This issues with the approval of Secretary, Establishment Division, Islamabad.

MUHAMMAD AWAIS JAVED,
Section Officer (Admn).

(Poverty Alleviation & Social Safety Division)

Islamabad, the 10th February, 2021

No. PASSD.SO.P. 1-8/2020(Admn)/152.—In pursuance of Establishment Division's Notification No. PF(1188)/E-5(PAS), dated 25th January, 2021 regarding posting of Rani Hafsa Kanwal, a BS-18 officer of Pakistan Administrative Service, the notification of even number of this Division dated 25th January, 2021 is hereby withdrawn *ab-initio*.

GUL ZAMAN,
Section Officer (Admn).

[BENAZIR INCOME SUPPORT PROGRAMME]

Islamabad, the 14th January, 2021

No. 1(1446)/BISP/HR/GB/2020.—Mr. Azeem Ahmed, Deputy Director (HQ) (SPS-18), BISP Regional Office GB is

granted 16 days leave on full pay (LFP) with effect from 11th January, 2021 to 26th January, 2021, alongwith permission to leave the station.

2. Mr. Bilal Hussain, Deputy Director (Initiatives) (SPS-18) BISP Regional Office GB is assigned lookafter work of the post of Deputy Director (HQ) BISP Regional Office GB, during the leave period of Mr. Azeem Ahmed, in addition to his own duties.

3. This issues with the approval of the Director General (Admin & HR), BISP.

Islamabad, the 18th January, 2021

No. F. 1(1212)/BISP/HR/BAL/2018.—Syed Saifullah, Deputy Director (WeT) (SPS-18), Regional Office BISP Balochistan is hereby granted Additional Charge of the vacant post of Deputy Director (Admin), (SPS-18) for a period of three months, with effect from 24th December, 2020, in addition to his own duties, or till appointment of a regular incumbent of the post, whichever is earlier.

This issues with the approval of the Director General (Admin & HR), BISP.

MUHAMMAD AHMAD USMANI,
Deputy Director (HR-III).

Islamabad, the 12th January, 2021

No. 1(976)/BISP/HR/KP/2017.—Mr. Anwar-ul-Haq, Assistant Director (SPS-17), BISP Tehsil Office, FR Kohat KP Region, is hereby granted lookafter charge of the post of AAO, BISP Divisional Office, Kohat, in addition to his own duties and allowed to act as co-signatory, with immediate effect and until further orders.

This issues with the approval of the Director General (Admin & HR), BISP.

Islamabad, the 19h January, 2021

No. 1(1303)/BISP/HR/KP/2018.—Mr. Farooq Sultan Khattak, Divisional Director, BISP Kohat, is hereby assigned additional charge of the post of Divisional Director, Bannu, with effect from 16th January, 2021 to 15th April, 2021, in addition to his own duties, for a period of three months or till posting of a regular incumbent, whichever is earlier.

This issues with the approval of the Secretary, BISP.

ZAHEER HUSSAIN,
Deputy Director (HR-II).

Islamabad, the 20th January, 2021

No. 1(1192)/BISP/HR/2018.—In terms of Rule 5 (a) of the Revised Leave Rules, 1980 (as amended from time

to time), Syed Tauqeer Hussain, Director (CP/Legal) (SPS-19), BISP HQ, Islamabad is granted 8 days leave on full pay with effect from 25th December, 2020 to 1st January, 2021 on account of illness (Covid-19).

This issues with the approval of the Director General (Admin & HR), BISP HQ.

MUHAMMAD SALEEM ULLAH,
Deputy Director (HR),
(HQ Establishment).

WAFAQI MOHTASIB (OMBUDSMAN)'S SECRETARIAT

Islamabad, the 12th January, 2021

No. F. 1(1025)A-II/2019.—In pursuance of this Secretariat's Office Order No. 3(180)A-II/2019, dated 16th December, 2020, Mr. Ammar Javaid Siddiqui Investigation Officer (BS-17) has assumed the charge of the said post at WMS, Regional Office, Faisalabad on 1st January, 2021 after relinquishment of charge from Head Office, Islamabad.

This issues with the approval of Competent Authority.

No. F. 1(1026)A-II/2019.—In pursuance of this Secretariat's Office Order No. 3(180)A-II/2019, dated 16th December, 2020, Mr. Kamran Maqsood Investigation Officer (BS-17) has assumed the charge of the said post at WMS, Regional Office, D. I. Khan on 1st January, 2021 after relinquishment of charge from Regional Office, Faisalabad..

This issues with the approval of Secretary, WMS.

Islamabad, the 15th January, 2021

No. F. 1(561)A-II/2011.—Syed Alim Raza Naqvi, Assistant Director Accounts (BS-17), Wafaqi Mohtasib Secretariat, Head Office Islamabad, is hereby granted 550 days leave ex-Pakistan (on half pay), with effect from 18th January, 2021.

After availing the said leave, the officer shall assume charge of the same post and station.

This issues with the approval of Competent Authority.

MOINUDDIN A. SIDDIQI,
Director (Admn).

FEDERAL TAX OMBUDSMAN SECRETARIAT

Islamabad, the 14th January, 2021

No. 1(142)/2002-A-I.—Syed Sarwar Zia Zaidi, Private Secretary (BS-17), Federal Tax Ombudsman Secretariat, Regional Office, Lahore shall stand retired from

Government Service on attaining the age of superannuation on 26th February, 2021.

SAJJAD AHMED,
Assistant Director (Estab).

January, 2021, Mr. Muhammad Naseer, BS-20 officer of Commerce and Trade Group, is transferred and his services are placed at the disposal of Intellectual Property Organization (IPO) as Executive Director (BS-20) under Ministry of Commerce on deputation basis for a period of two (2) years on standard terms and conditions, with immediate effect and until further orders.

MINISTRY OF COMMERCE

Islamabad, the 18th January, 2021

No. 1(10)/2005-AOs.—The Federal Government is pleased to appoint Secretary, Trade Development Authority of Pakistan (*ex-officio*) as Chairman, Board of Directors (BoD) of Pakistan Expo Centers (Pvt.) Ltd., by virtue of being member of the BoD.

SIDRA MUNAF,
Section Officer (AOs).

Islamabad, the 14th January, 2021

No. 15(10)/2003-Admn-III/CTG.—Consequent upon Ministry of Commerce's Notice No. 2(42)/2019-Admn-II (TO-I) dated 1st January, 2021, Mr. Atif Aziz, Trade and Investment Counsellor, Los Angles (BS-19/CTG), will be joining Ministry of Commerce on 15th March, 2021. The officer will be posted in Trade Development Authority of Pakistan as Director General to actualize his promotion in BS-20.

2. The intervening period is regularized as under :-

Relinquished of charge of TIC at Parep Los Angles	05-03-2021
Six (6) days joining time	06-03-2021 to 11-03-2021
Transit	12-03-2021 to 14-03-2021
Assumed the charge in Ministry of Commerce.	15-03-2021

No. 1(18)/2018-DD/CTG.—Mr. Imdad Ali, BS-17 officer of Commerce and Trade Group, presently posted as Assistant Director, Trade Development Authority of Pakistan, Karachi is granted one year premature LPR with effect from 1st January, 2021 to 31st December, 2021.

The officer shall stand retired from Government Service on 31st December, 2021.

This issues with the approval of Secretary Commerce.

Islamabad, the 20th January, 2021

No. 4(18)/80-Admn.III.—In pursuance of Establishment Division's Notification No. 1/341/2020-E-4, dated 19th

No. 15(6)/2009-Admn-III/CTG.—The deputation period of Mr. Umer Kamal, BS-18 officer of Commerce and Trade Group, presently posted in Pakistan Horticulture Development and Export Company on deputation basis, is extended from 1st January, 2021 till further orders.

SABIHA PARVEEN,
Deputy Director (CTG).

Islamabad, the 12th January, 2021

No. 7(21)/2020-Admn-I/HR-I.—Ms. Sana Shouket, BS-17 officer of Office Management Group, posted as Section Officer (Establishment), Ministry of Commerce, Islamabad, had been assigned additional charge for the post of Deputy Director (CTG), with effect from 7th October, 2020 to 29th November, 2020.

This issues with the approval of Secretary Commerce.

No. 2(263)TID/19-Admn-I/HR-I.—Mr. Umar Farooq, BS-17 officer of Office Management Group, posted as Section Officer (TR-II), Ministry of Commerce, Islamabad, had been assigned additional charge for the post of Section Officer (TR-I), Ministry of Commerce, with effect from 26th August, 2020 to 25th November, 2020.

This issues with the approval of Secretary Commerce.

Islamabad, the 15th January, 2021

No. 7(31)/2020-Admn-I/HR-I.—In pursuance of Ministry of Commerce's Notification No. 15(7)/2004-Admn-III/CTG, dated 9th November, 2020, consequent upon his transfer, Mr. Fahad Raza, BS-19 officer of Commerce & Trade Group, has assumed charge of the post of Director, Ministry of Commerce, Islamabad on 9th November, 2020.

Islamabad, the 18th January, 2021

No. 7(1)/2020-Admn-I/HR-I.—Mr. Umer Hayat, Section Officer (BS-18/OMG), Ministry of Commerce, Islamabad, was granted forty five (45) days *Ex-Pakistan* Leave on full pay, with effect from 16th November, 2020 to 30th December, 2020, *vide* this Ministry's notification of even number dated 29th September, 2020. However, due to the global pandemic situation of COVID-19 and Government of Pakistan's policy of mandatory home quarantine for travelers from UK, the officer has reported for duty in Ministry of Commerce, Islamabad on 13th January, 2021.

The competent authority, *i.e.* Special Secretary Commerce has decided to regularize the intervening period

in respect of the officer as under :-

Islamabad, the 14th January, 2021

31-12-2020 to 05-01-2021	The period is hereby regularized as six (6) days <i>Ex-Pakistan Leave on Full Pay.</i>
06-01-2021 to 12-01-2021	The period is hereby regularized as seven (7) days <i>Leave on Full Pay.</i>

No. 8(61)/2013-Admn-I/HR-II.—Consequent upon his request and with approval of the Special Secretary Commerce, Mr. Tahir Ali Zaidi, Private Secretary (BS-18), Ministry of Commerce is granted sixty (60) days leave on full pay with effect from 18th January, 2021 to 18th March, 2021.

MUHAMMAD IMTIAZ,
Deputy Director (HR-I).

2. Mr. Muhammad Kamran, Assistant Private Secretary (BS-16) is posted in the office of Additional Secretary (Trade Diplomacy) as a substitute of Mr. Tahir Ali Zaidi.

MUHAMMAD ARSHID,
Deputy Director (HR-II).

Islamabad, the 11th January, 2021

No. 8(62)/2013-Admn-I/HR-II.—Consequent upon his request and with approval of the competent authority, Mr. Farman Ali, Assistant Private Secretary (BS-16), Ministry of Commerce is granted ninety (90) days leave on full pay with effect from 11th January, 2021 to 10th April, 2021.

After expiry of the aforesaid leave the officer will resume his duties on the same post and place.

No. 10(6)/85-Admn-I/HR-II.—In pursuance of this Ministry's of notification of even number dated 15th July, 2020, Mr. Shahid Ahmed, has relinquished the charge of the post of Assistant Private Secretary (BS-16) in the Ministry of Commerce, Islamabad on 11th January, 2020 on attaining the age of superannuation.

MINISTRY OF COMMUNICATIONS

Islamabad, the 13th January, 2021

No. Misc./2020-Secy(C).—On the basis of request dated 11th January, 2021 of Mr. Muhammad Akhlaque Rana, Director General (BS-22), PPOD/Chairman, Pakistan Postal Services Management Board (P.P.S.M.B.), Islamabad, the Federal Ministry for Communications is pleased to grant him L.F.P. with effect from 13th January, 2021 to 3rd April, 2021 (81 days) *i.e.* his date of superannuation.

ATA HUSSAIN SHAH,
Deputy Secretary (PO).

DEPARTMENT OF THE AUDITOR-GENERAL OF PAKISTAN

Islamabad, the 7th January, 2021

No. 02-Dir(A)/2-4/21.—The Auditor General of Pakistan has been pleased to order postings/transfers of following officers of the Pakistan Audit & Accounts Service, in the Public interest with immediate effect and until further orders :-

S. No.	Name of officers (M/s.)	From	To	Remarks
1.	Hashim Raza BS-19/PA&AS	Repatriation from deputation as Treasurer, SZALB Medical University, PIMS, Islamabad	Director Audit, (Federal Govt.) Islamabad	Vice Sr. 2
2.	Amad Afzal Mir BS-19/PA&AS	Director Audit, (Federal Govt.) Islamabad	Director (Specialized Audit Unit) / SSA Wing, AGP Office, Islamabad	—
3.	Qadeer Ahmed BS-19/PA&AS	Awaiting for posting at AGP Office, Islamabad, (on return from leave with effect from 27th November, 2020).	Director Commercial Audit & Evaluation (South), Karachi	The officer was granted <i>Ex-Pakistan LHP</i> for 210 days. However, the officer curtailed his leave after availing 39 days <i>i.e.</i> 19th October, 2020 to 26th November, 2020.

Islamabad, the 8th January, 2021

No. 04/Dir(A-II)/2(5/6)/2020.—The Competent Authority has been pleased to withdraw this office earlier Notification No. 32-Dir(A)-II/1-6/induction/2017/Vol-I dated October 16, 2020 to the extent of posting/transfer of Mr. Yaseen Qurban as Deputy Accountant General, O/o. the AG Sindh, Karachi, against a vacant post.

MUHAMMAD TAYYAB,
Director (Admn).

Islamabad, the 7th January, 2021

No. 04/PAAS-II/38-2020.—Consequent upon promotion to the post of Deputy Director/equivalent (BPS-18) on Regular Basis *vide* Notification No. 42-Dir(A-II)/2(5/6)/2020-II dated 10th December, 2020 and posting/transfer *vide* Office of the Auditor General of Pakistan, Islamabad Notification No. 42-Dir(A-II)/2(5/6)/2020-II dated 10th December, 2020; Mr. Muhammad Usama Kabbir has relinquished the charge of the post of Deputy Director, in O/o. the Director General Audit, Defence Services, (South) Karachi (OPS) on 31st December, 2020 and assumed the charge of the post of Deputy Accountant General (BS-18) in O/o. the Accountant General Sindh Karachi on 1st January, 2021.

No. 05/PAAS-I/42-2016.—Consequent upon his selection as Community Welfare Attache Pakistan Mission Abu Dhabi as communicated *vide* Ministry Overseas Pakistanis & Human Resource Development's O. M. No. 1 (6)/2020-CWA-I dated 22nd October, 2020 and subsequent relieving & placement of his services at the disposal of Ministry of Overseas Pakistanis & Human Resource Development with effect from 18th December, 2020 *vide* O/o. Auditor General of Pakistan Islamabad's Letter No. 875/Dir(A-II)/2-(5/6)/2020-I dated 17th December, 2020, Mr. Sami Ullah Khan a BS-18 PA&AS officer has relinquished the charge of the post of Deputy Director (HRM) O/o. Auditor General of Pakistan Islamabad on 18th December, 2020 (19th & 20th December, 2020 being Saturday & Sunday respectively) and assumed the charge of the post of Community Welfare Attache, Embassy of Pakistan, Abu Dhabi on 27th December, 2020 after availing permissible joining time.

No. 03/PAAS-II/2-1857/2020.—Mr. Munawar Hussain, BS-17 officer of Pakistan Audit Department presently serving in Director General Audit (Railways) Lahore as Assistant Director shall stand retired from Government Service upon attaining the age of superannuation on 1st February, 2021. His date of birth is 1st February, 1961.

NADIA USMAN,
Assistant Auditor General (PAAS).

Islamabad, the 6th January, 2021

No. 7/Estt-C/01-2016-I.—Consequent upon retirement on superannuation basis, Mr. Rahmat Ali, Audit Officer (BPS-18), O/o. the Director General Audit, Inland Revenue and Custom, Lahore stood retired from Government Service

on 14th December, 2020 (his date of Birth being 15th December, 1960).

No. 9/Estt-C/01-2016-I.—Consequent upon retirement on superannuation basis, Mr. Farman Ali, Audit Officer (BPS-18), O/o. the Director General Audit, Khyber Pakhtunkhwa, Peshawar shall stand retired from Government Service on 31st March, 2021 (his date of Birth being 1st April, 1961).

MUHAMMAD IMRAN SARWAR,
Audit Officer (Estt.).

[OFFICE OF THE CONTROLLER GENERAL OF ACCOUNTS]

Islamabad, the 6th January, 2021

No. 26/CGA/Admn-I/03-14/2002.—Consequent upon his posting on deputation in Printing Corporation of Pakistan Islamabad *vide* this office Letter No. 995/CGA/Estt/Dep-4/2017 dated 24th December, 2020 Mr. Khalid Nazir, Accounts Officer (BS-18) of this office has relinquished the charge of his post on 31st December, 2020.

Islamabad, the 7th January, 2021

No. 33/CGA/Admn-I/04-41/2018.—Consequent upon his repatriation to his parent department Accountant General of Pakistan Revenues Islamabad *vide* this office Notification No. 989/CGA/Estt-II/AAO/AGPR/PT/1-C/Vol-II dated 23rd December, 2020 Mr. Dildar Husnain, Senior Auditor (BS-16) of this office has relinquished the charge of his post on 31st December, 2020.

JIBRAN KHAN DURRANI,
Assistant Controller General of Accounts (Admin).

Islamabad, the 7th January, 2021

No. 14/CGA/Estt-II/Dep-1/2017.—The Deputy Controller General of Accounts has been pleased to order the repatriation of Ms. Huma Ismail, Assistant Accounts Officer (BPS-17) from the Punjab Workers Welfare Board, Lahore to join her parent department *i.e.* Office of the Director General Accounts Works, Lahore with immediate effect.

Islamabad, the 8th January, 2021

No. 19/CGA/Estt-II/AAO/DBA/PT/17-C.—The Deputy Controller General of Accounts has been pleased to order the repatriation of Mr. Muhammad Atif, A. A.O. (BPS-17) of Directorate of Budget & Accounts Pak P.W.D. Islamabad from Project Monitoring & Evaluation Cell (PM&EC), Federal Board of Revenue, Islamabad to Join office of the Controller General of Accounts Head Quarters, Islamabad on temporary transfer basis with immediate effect.

No. 21/CGA/Estt-II/AAO/56-C/2010.—The Deputy Controller General of Accounts has been pleased to order

the repatriation of Mr. Daud Khan, Assistant Accounts Officer. (BPS-17) from the Directorate General Intelligence and Investigation (Customs) FBR-Peshawar to join his parent department *i.e.* office of the Accountant General Pakistan Revenues, sub office, Peshawar with immediate effect till further orders.

No. 22/CGA/Estt-II/AAO/56-C/2010.—The Deputy Controller General of Accounts has been pleased to post Mr. Farman Ali, Assistant Accounts Officer. (BPS-17) of Accountant General Pakistan Revenues, sub office, Peshawar to join office of the Directorate General Intelligence and Investigation (Customs) FBR-Peshawar against the cadre post of CGA organization, for the period of three years, with immediate effect, till further orders.

ROIDAR ALI,
Accounts Officer (Establishment).

[OFFICE OF THE DIRECTOR GENERAL ACCOUNTS WORKS]

Lahore, the 7th January, 2021

No. DGAW/Admn-I/PF-41/DD.—Consequent upon posting of Mr. Muhammad Saleem Akhtar, as Deputy Director (BS-18) in this office *vide* Controller General of Accounts Office Notification No, 538/CGA/PAAS/1-14/2017, dated 21st December, 2020, the officer has assumed the charge as Deputy Director in this office on 10th December, 2020.

MUHAMMAD SALEEM AKHTAR,
Deputy Director-I.

Islamabad, the 13th January, 2021

No. F. 3(1)/2021-Estt-I.—Consequent upon the recommendations of Departmental Promotion Committee and approval of the Appointing Authority, the following Election Officers (BS-17) and Assistant Directors (BS-17) of the Election Commission of Pakistan are promoted against the posts reserved for departmental promotion quota and appointed to higher posts *i.e.* BS-18 mentioned against their names with immediate effect and until further orders.

Sl. No.	Name of Officers	From	To
1	2	3	4
1.	Mr. Falak Naz	Election Officer (BS-17) in the O/o. District Election Commissioner, Chitral	District Election Commissioner (BS-18), Chitral
2.	Mr. Muhammad Irfan	Election Officer (BS-17) in the O/o. District Election Commissioner, Chakwal	Deputy Director (Elections-II) (BS-18) in the Election Commission Secretariat, Islamabad.
3.	Mr. Muhammad Tousif Qadir	Election Officer (BS-17) in the O/o. District Election Commissioner-I, Lahore	Deputy Director (LGE-KP) (BS-18) in the Election Commission Secretariat, Islamabad.
4.	Mr. Akbar Ali	Election Officer (BS-17) in the O/o. District Election Commissioner, Okara	District Election Commissioner (BS-18), Khanewal.

[OFFICE OF THE DIRECTORATE GENERAL AUDIT
(CLIMATE CHANGE AND ENVIRONMENT)]

Islamabad, the 6th January, 2021

No. Admn/PF-78/686.—In pursuance of the Directorate General Audit (Climate Change & Environment), Islamabad relieving orders No. Admn/PF-78/686, dated 31st December, 2020, Mr. Abdul Ghafoor has relinquished the charge of the post of Senior Auditor in the office of the Directorate General Audit (Climate Change & Environment), Islamabad on 31st December, 2020.

FAWAD AMIR CHAUDHRY,
Director.

ELECTION COMMISSION OF PAKISTAN

Islamabad, the 12th January, 2021

No. F. 15(3)/1993-Estt-I(Vol-III).—Mr. Javed Iqbal, Additional Director General (BS-20) (under suspension) in Election Commission, Secretariat, Islamabad is granted 32 days leave as mentioned below :-

- 15 days leave on full pay on medical grounds from 5th to 19th December, 2020 and
- 15 days leave on full pay from 20th December, 2020 to 3rd January, 2021.
- 2 days extra ordinary leave (without pay and allowances) from 7th to 8th January, 2021,

2. On expiry of leave on full pay, the above officer has assumed the charge of the same post at Islamabad on 4th January, 2021.

3. This has approval of the Secretary, Election Commission.

Sl. No.	Name of Officers	From	To
1	2	3	4
5.	Mr. Sattar Sardar	Election Officer (BS-17) in the O/o. District Election Commissioner, Sahiwal	Deputy Director (BS-18) in the O/o. PEC, Punjab, Lahore
6.	Mr. Inayat Hussain	Election Officer (BS-17) in the O/o. Regional Election Commissioner, Mirpurkhas	District Election Commissioner (BS-18), Karachi (South)
7.	Mr. Hamid Hussain	Election Officer (BS-17) in the O/o. District Election Commissioner, Karachi (Central)	District Election Commissioner (BS-18), Karachi (West)
8.	Mr. Saif-ur-Rehman	Election Officer (BS-17) in the O/o. Regional Election Commissioner, Hazara	Deputy Director (LGE-Sindh) (BS-18) in the Election Commission Secretariat, Islamabad.
9.	Syeda Humaira Bint-e-Maaz	Election Officer (BS-17) in the O/o. District Election Commissioner, Karachi (West)	District Election Commissioner (BS-18) Keamari (on acting charge)
10.	Mr. Javed Iqbal	Assistant Director (LGE-Sindh) (BS-17) in the Election Commission Secretariat, Islamabad	District Election Commissioner-II (BS-18), Multan
11.	Mr. Muhammad Siddique	Assistant Director (Estt-II) (BS-17) in the Election Commission Secretariat, Islamabad	District Election Commissioner-I (BS-18), Rawalpindi

2. The officer shall be on probation and the period of their probation shall be regulated under Section 6 of the Civil Servants Act, 1973 read with Rule 21 of the Civil Servants (Appointment, Promotion & Transfer) Rules, 1973.

3. The promotions of officers mentioned above are made without prejudice to the seniority of the officer(s) senior to them whose cases have been deferred and on promotion they will retain their *inter-se-seniority*.

4. This has approval of the Hon'ble Chief Election Commissioner.

No. F. 3(1)/2021-Estt-I.—The postings/transfers of the following officers under the Election Commission of Pakistan are made with immediate effect and until further orders on administrative grounds and in the public interest :-

Sl. No.	Name of Officers	From	To
1	2	3	4
1.	Mr. Abdus Samad Khan	District Election Commissioner, Karachi (West)	Deputy Director (SIMS) in the Election Commission Secretariat, Islamabad
2.	Mr. Muhammad Samiullah	District Election Commissioner, Karachi (South)	Deputy Director (Electoral Rolls) in the ECP Secretariat, Islamabad
3.	Mr. Asghar Ali	Deputy Director in the O/o. PEC, Punjab, Lahore	District Election Commissioner, Vehari
4.	Mr. Muhammad Imran	District Election Commissioner Vehari (on acting charge)	Deputy Director in the O/o. PEC, KP, Peshawar (on acting charge)
5.	Mr. Ibrar Ahmed Jatoi	District Election Commissioner, Lodhran	District Election Commissioner, Bahawalpur

Sl. No.	Name of Officers	From	To
1	2	3	4
6.	Mr. Muhammad Adnan Zafar	District Election Commissioner, Bahawalnagar	District Election Commissioner, Lodhran
7.	Mr. Tanveer Ahmed Humayun	Deputy Director in the O/o. PEC, Punjab, Lahore	District Election Commissioner, Bahawalnagar
8.	Mr. Muhammad Mumtaz	Deputy Director in the O/o. PEC, KP, Peshawar	Deputy Director in the O/o. PEC, Punjab, Lahore
9.	Mr. Wazir Akbar	District Election Commissioner, Mohmand	Deputy Director in the O/o. PEC, KP, Peshawar
10.	Mr. Azhar Hussain Tanwri	District Election Commissioner, Naushehro Feroze	District Election Commissioner, Badin
11.	Mr. Saleemuddin	District Election Commissioner, Badin	District Election Commissioner, Naushehro Feroze
12.	Mr. Pervaiz Ahmed Kalwar	District Election Commissioner, Jacobabad	District Election Commissioner, Shaheed Benazirabad
13.	Mr. Zahid Hussain Bhutto	District Election Commissioner, Shaheed Benazirabad	District Election Commissioner, Jacobabad
14.	Mr. Zafar Iqbal	Election Officer in the O/o. District Election Commissioner, Zhob	Election Officer in the O/o. District Election Commissioner, Chiniot

2. This has approval of the Hon'ble Chief Election Commissioner.

Islamabad, the 15th January, 2021

No. F. 3(1)/2021-Estt-I.—Mr. Gulzar Akhtar, a BS-18 officer of the Election Commission of Pakistan, presently posted as District Election Commissioner, Sheerani, is transferred and posted against the vacant post of District Election Commissioner, Toba Tek Singh with immediate effect and until further orders.

2. Mr. Safdar Naseer, a BS-18 officer of the Election Commission of Pakistan, presently posted as District Election Commissioner, Musakhel is assigned additional charge of the post of District Election Commissioner, Sheerani with immediate effect initially for a period of 3 months or till the regular appointment against this post, whichever is earlier.

3. This has approval of the *Hon'ble* Chief Election Commissioner.

No. F. 3(1)/2021-Estt-I.—Consequent upon the recommendations of Departmental Promotion Committee and approval of the Appointing Authority, Mr. Aaber Farooque presently working as Assistant Director (LGE-Punjab-BS-17) in this Secretariat is promoted against

the post reserved for departmental promotion quota and appointed as Deputy Director (BS-18) in the office of Provincial Election Commissioner, Punjab. Lahore with immediate effect and until further orders.

2. He shall be on probation and the period of his probation shall be regulated under Section 6 of the Civil Servants Act, 1973 read with Rule 21 of the Civil Servants (Appointment, Promotion & Transfer) Rules, 1973.

3. This has approval of the *Hon'ble* Chief Election Commissioner.

Islamabad, the 19th January, 2021

No. F. 15(23)/93-Estt-I.—In continuation of this Commission's notification of even number dated 29th December, 2020, Mr. Abdul Hafeez, a BS-19 officer of Election Commission of Pakistan, presently posted as Director in this Secretariat, is granted 7 days extension in leave on full pay from 30th December, 2020 to 5th January, 2021.

2. On expiry of leave, the above officer has assumed the charge of his post at Islamabad on 6th January, 2021.

3. This has approval of the Secretary, Election Commission. [OFFICE OF THE PROVINCIAL ELECTION COMMISSIONER, PUNJAB]

No. F. 3(4)/2021-Estt-I.—In continuation of this Commission's Notification No. 3(4)/2020-Estt-I dated 21st October, 2020, the current / additional charge of the following vacant posts assigned to the following officers is hereby extended for further period of three (3) months with effect from the date mentioned against them or till the regular appointment against the post, whichever is earlier.

S. No.	Name & Designation	Extension of Current/ Additional Charge	Date of Extension
1.	Mr. Mitha Khan, District Election Commissioner (BS-18), Nushki	Regional Election Commissioner Rakhshan (BS-19)	21st January, 2021
2.	Mr. Gazain Baloch, District Election Commissioner (BS-18), Kharan	District Election Commissioner, Washuk	

2. This has approval of the *Hon'ble* Chief Election Commissioner.

No. F. 15(19)/2007-Estt-I.—Mr. Ajmal Hafeez, a BS-18 officer of Election Commission of Pakistan (ECP), presently working as District Election Commissioner, Bajaur, is granted tharity (30) days leave on full pay from 18th January to 16th February, 2021 alongwith prefix closed holidays falling on 16th & 17th January, 2021.

2. On expiry of leave, the above officer is likely to assumed the charge of the same post and station.

3. Mr. Umar Khan, a BS-17 officer of ECP presently posted as Election Officer, Bajaur is assigned current charge of the above post, during the leave period of Mr. Ajmal Hafeez.

4. This has approval of the *Hon'ble* Chief Election Commissioner.

IMRAN ZAFAR,
Deputy Director (Estt-I).

[OFFICE OF THE PROVINCIAL ELECTION COMMISSIONER,
BALOCHISTAN]

Quetta, the 14th January, 2021

No. F. 3(309)/2015-Estt.—Mr. Gazain Baloch, District Election Commissioner, Kharan is granted 11 days leave on full pay with effect from 4th January, 2021 to 14th January, 2021 alongwith permission to leave the station.

On the expiry of leave, he is likely to assumed his charge on the same post at the same station.

MUHAMMAD YAQOOB RIND,
Deputy Director (Estt).

Lahore, the 12th January, 2021

No. F. 9(10)/2017-Estt.—Mrs. Anam Pervaiz, Assistant Director of this office is granted 90 days Maternity Leave with effect from 6th January, 2021 to 5th April, 2021.

On the expiry of leave, she is likely to resume her duty on the same post at the same station.

Lahore, the 15th January, 2021

No. F. 9(4)/97-Estt-Vol-II.—Consequent upon his transfer from D. G. Khan to Muzaffargarh *vide* this Office Notification No. F. 3(2)/2009-Estt-Vol-I dated 16th December, 2020, Mr. Nasir Maqsood, Election Officer, has relinquished the charge as Election Officer (Strong-Room) in the office of Regional Election Commissioner, D. G. Khan, in the afternoon of 24th December, 2020, he has assumed the charge as Election Officer, in the office of District Election Commissioner, Muzaffargarh, in the forenoon of 31st December, 2020.

Lahore, the 19th January, 2021

No. F. 3(1)/2019-Vol-I.—In compliance of Election Commission of Pakistan, Islamabad Letter No. F. 7(1)/2019-Estt-II (Vol-II), dated 15th January, 2021, the Competent Authority has been pleased to extend the contract period of Mr. Abdul Rauf, Assistant Private Secretary, *Ex-Election Tribunal* (Local Government Elections-2015), with effect from 1st December, 2020 to 31st January, 2021, presently working in the office of Regional Election Commissioner, D. G. Khan, and he will continue his service on contract basis till 31st January, 2021.

TAHIR MANSOOR KHAN,
Director (Estt).

MINISTRY OF ENERGY

(Petroleum Division)

Islamabad, the 12th January, 2021

No. 4(133)/2020-Admn.—Pursuant to Establishment Division's Letter No. 4/1/2019-T-I, dated 11th August, 2020 and after completion of Training at National Defence University (NDU), Islamabad, Mr. Akbar Ali Khan, has assumed the charge of the post of Chief Finance & Accounts Officer (CF&AO)/BS-20 in this Division on 4th January, 2021.

This issues with the approval of Secretary (petroleum Division).

SHAHBAZ KHAN,
Section Officer (Admn).

Islamabad, the 18th January, 2021

No. F. 5(9)/2018-Oil.—Consequent upon the approval of the competent authority *i.e.* Secretary, petroleum Division, Mr. Abdul Ali Khan, Director (BS-19), Department of

Explosives, currently posted at the Head Office, Islamabad is granted the current charge for the post of Director General, Department of Explosives with effect from 7th January, 2021 for a period of three (03) months or till the appointment of regular incumbent, whichever is earlier.

MUHAMMAD OMAR FAROOQ MAHAR,
Section Officer (Oil).

(Power Division)

Islamabad, the 11th January, 2021

No. 4(397)/2020-Admn.—Mr. Nasar Hayat, Section Officer (Dev), Ministry of Energy (Power Division) is granted 60 days LFP from 11th January, 2021 to 11th March, 2021.

On expiry of leave the officer shall resume his duty on the same post and at the same station.

Islamabad, the 12th January, 2021

No. 9(5)/2015-Admn.—In pursuance of Federal Cabinet's decision in case number 09/01/2021, dated 5th January, 2021, the resignation tendered by Dr. Rana Abdul Jabbar from the post of Chief Executive Officer, AEDB is accepted with effect from Jan. 12, 2021.

No. 9(5)/2015-Admn.—In pursuance of Federal Cabinet's decision in case number 09/01/2021, dated 5th January, 2021, Mr. Shah Jahan Mirza, MD PPIB shall also work as CEO AEDB in addition to his own duties, for period of 2 months or till appointment of regular CEO AEDB, whichever is earlier.

Islamabad, the 18th January, 2021

No. 4(404)/2021-Admn.—In pursuance of Establishment Division's Notification No. PF (682)/E.5 (PAS), dated 15th January, 2021, Mr. Hamed Yaqoob Sheikh, a BS-21 officer of Pakistan Administrative Service, has assumed the charge of the post of Special Secretary, Ministry of Energy (Power Division) on 18th January, 2021, under Section-10 of the Civil Servants Act, 1973.

No. 9(5)/2015-Ent.—In pursuance of Federal Cabinet's decision in case number 09/01/2021, dated 5th January, 2021, and this Division's Notification No. 9(5)/2015-Ent. dated 12th January, 2021, Mr. Shah Jahan Mirza, has assumed the charge of the post of Chief Executive Officer Alternative Energy Development Board (AEDB) on 13th January, 2021.

No. 9(5)/2015-Ent.—In pursuance of Federal Cabinet's decision in case number 09/01/2021, dated 5th January, 2021, and this Division's Notification No. 9(5)/2015-Ent. dated 12th January, 2021, Dr. Rana Abdul Jabbar Khan, has relinquished the charge of the post of Chief Executive Officer, AEDB on 12th January, 2021.

UMER VAQAR,
Section Officer (Admn).

Islamabad, the 12th January, 2021

No. Ent. 2(04)/2016-PPIB/BoD.—Consequent upon approval of the Cabinet in terms of Section-4 of the AEDB

Act, 2010, in Cabinet's meeting held on 18th December, 2020, in Case No. 1023/50/2020, dated 22nd December, 2020, the Secretary, Ministry of Energy (Power Division) is appointed as the Chairman, Alternative Energy Development Board (AEDB) with effect from 18th December, 2020 and until further orders.

No. Ent. 2(04)/2016-PPIB/BoD.—Consequent upon approval of the Cabinet in its meeting held on 18th December, 2020, in Case No. 1023/50/2020, dated 22nd December, 2020, the resignation tendered by the Mr. Omer Ayub Khan, Minister for Energy (Power Division), as the Chairman Alternative Energy Development Board (AEDB) and Chairman Private Power Infrastructure Board (PPIB), and Chairman National Energy Efficiency & Conservation Authority (NEECA), stands accepted.

No. Ent. 2(04)/2016-PPIB/BoD.—Consequent upon approval of the Cabinet in terms of Section-8 (1) of PPIB Act, 2012 and salutary principle of law "salus populi est suprema lex", in Cabinet's meeting held on 18th December, 2020, in Case No. 1023/50/2020, dated 22nd December, 2020, the Secretary, Ministry of Energy (Power Division), (a member of the PPIB Board) is allowed to preside over the meetings and exercise the other powers of the Chairman of Private Power & Infrastructure Board (PPIB) with effect from 18th December, 2020 till amendment of the PPIB Act, 2012 or till further orders.

SHAKILA BEGUM,
Section Officer (Ent.).

MINISTRY OF FEDERAL EDUCATION AND
PROFESSIONAL TRAINING

Islamabad, the 14th January, 2021

No. F. 10-5/2020 (IC-I).—In terms of Sr. No. 1 of the Schedules IV [Rule 7(2)] of the rules of Business, 1973, giving list of Officers Authorized to make and Execute Orders and other Instruments in the name of the President of Pakistan, Mr. Ishfaq Ahmad Hiraj Section Officer, IC-I of this Ministry is hereby authorized to sign financial sanctions in respect of department/projects dealt by him as Section Officer (IC-I) including grant-in-aid to the American Institute of Pakistan Studies.

ASMAT ULLAH KHAN,
Deputy Secretary (IC).

Islamabad, the 14th January, 2021

No. F. 1-46/2014-NCC/RE.—Syed Junaid Akhlaq, Joint Secretary (Admn), M/o. FE&PT, is granted the look-after charge of the posts of the Director General, Directorate General of Religious Education (DGRE) (BS-20), Islamabad and the Chairman (BS-20), Pakistan Madrassah Education Board (PMEB), Islamabad with immediate effect and until further orders. The Joint Secretary (Admn), M/o. FE&PT has been assigned to exercise the Administrative and Financial Powers of both DGRE and PMEB.

This issues with approval of the Secretary, M/o. FE&PT, Islamabad.

KANWAL JAVED,
Deputy Secretary (Admn).

Islamabad, the 12th January, 2021

No. F. 9-221/2019/MC/FDE.—On having been found guilty of “misconduct” under rule 3 (b) of Government Servants (Efficiency & Discipline) Rules 1973, due to charge of unauthorized absence from Government duty with effect from 20th February, 2017 as contained in the charge sheet bearing No. F. 9-221/2018/MC/FDE, dated 14th May, 2020 & Show Cause Notice dated 3rd December, 2020 along with inquiry report bearing No. F. 9-221/2018/MC/FDE and on the recommendation of Authorized Officer in terms of rule 5 (1) (iv) *ibid*, the Competent Authority *i.e.* Secretary, Ministry of Federal Education & Professional Training, Islamabad has imposed the major penalty *i.e.* “Removal from Service” under Section 4 (b) (iii) of Government Servants (Efficiency and Discipline) Rules 1973 on Mr. Rizwan-ul-Haq, Lecturer (BS-17), Islamabad Model College for Boys (IMCB), F-8/4, under Federal Directorate of Education, Islamabad with immediate effect.

2. He can make an appeal/representation against award of major penalty to the appellate authority next above the authority through proper channel within 30 days from the date of issuance of this notification.

Islamabad, the 19th January, 2021

No. F. 5-13/1993(CA)/FDE.—On having been found guilty of “misconduct” under rule 3 (b) of Government Servants (Efficiency & Discipline) Rules 1973, due to charge of unauthorized absence from Government duty with effect from 10th August, 2012 as contained in the charge sheet bearing No. F. 5-13/1993(CA)/FDE, dated 21st February, 2020 & Show Cause Notice dated 10th August, 2020 along with inquiry report dated 16th March, 2020 and on the recommendation of Authorized Officer in terms of rule 5 (1) (iv) *ibid*, the Competent Authority *i.e.* Secretary, Ministry of Federal Education & Professional Training, Islamabad has imposed the major penalty *i.e.* “Removal from Service” under Section 4 (b) (iii) of Government Servants (Efficiency and Discipline) Rules 1973 on Mr. Muhammad Afzal Awan, Assistant Professor (BS-18), Islamabad Model College for Boys (IMCB), H-9, under Federal Directorate of Education, Islamabad with immediate effect.

2. He can make an appeal/representation against award of major penalty to the appellate authority next above the authority through proper channel within 30 days from the date of issuance of this notification.

MUHAMMAD ZULFIQAR JATOI,
Section Officer (Colleges).

Islamabad, the 14th January, 2021

No. F. 17-307/2001-SST (W) FDE/SO (S).—On having been found guilty of “misconduct” under rule 3 (b) of

Government Servants (Efficiency & Discipline) Rules 1973, on accounts of unauthorized absence from Government duty with effect from 1st December, 2014 as contained in charge sheet bearing No. F. 277/IMSG/2020, dated 9th March, 2020 and final show cause notice No. F. 1/297/IMSG, G-11/1, dated 25th August, 2020 and on the recommendation of Authorized Officer in terms of rule 5 (1) (iv) *ibid*, Competent Authority *i.e.* Secretary, Ministry of Federal Education & Professional Training, has imposed major penalty *i.e.* “Removal from Service” under rule 4 (1) (b) (iii) of Government Servants E&D Rules, 1973, on Ms. Nargis Jalal, SST (BPS-17), Islamabad Model School (I-V) F-10/2, Islamabad, under Federal Directorate of Education with immediate effect.

2. She can make an appeal/representation against award of major penalty to the appellate authority next above the authority through proper channel within 30 days from the date of issuance of this notification.

MUSAWIR SIFAT,
Section Officer (Schools).

Islamabad, the 11th January, 2021

No. F. 4-1/2019-Prom(DSB)(1).—Consequent upon recommendations of the Departmental Selection Board (DSB) in its meeting held on 29th December, 2020 and with the approval of Secretary, Federal Education and Professional Training Division, Mrs. Niana Syed, Assistant Professor (BS-18) in Federal College of Education (FCE) Islamabad is promoted as Associate Professor (BS-19) FCE with immediate effect.

On promotion she shall be on probation for a period of one year, under rule 21 of the Civil Servants (APT) Rules, 1973.

No. F. 4-1/2019-Prom(DSB)(2).—Consequent upon recommendations of the Departmental Selection Board (DSB) in its meeting held on 29th December, 2020 and with the approval of Secretary, Federal Education and Professional Training Division, Mr. Rooh-ul-Amin, Assistant Professor (BS-18) in Federal College of Education (FCE) Islamabad is promoted as Associate Professor (BS-19) FCE with immediate effect.

On promotion he shall be on probation for a period of one year, under rule 21 of the Civil Servants (APT) Rules, 1973.

GHULAM MURTAZA,
Section Officer (Promotion).

MINISTRY OF FINANCE, REVENUE, AND ECONOMIC
AFFAIRS

(Finance Division)

[HRM WING]

Islamabad, the 15th January, 2021

No. P.F. 8(63)/HR.IV/2017.—In pursuance of Office of the Military Accountant General, Rawalpindi Letter No. 94/AN/902-242(35423), dated 4th January, 2021, extension in deputation period in respect of Mr. Shahid Rauf,

Assistant Accounts Officer (BS-17) in Finance Division, Islamabad is hereby extended for a period of two years with effect from 17th October, 2020.

This issues with the approval of Additional Finance Secretary.

MUHAMMAD HAYAT,
Section Officer (HR-IV).

(Revenue Division)

Islamabad, the 20th January, 2021

No. 6(11)/2011-Admn.—Ms. Madeeha Khattak, Section Officer (Admn) of this Division is hereby assigned additional charge of the post of Section Officer (Gen.), in addition to her own duties with effect from 14th January, 2021 initially for a period of three months, or till the posting of regular Section Officer by Establishment Division whichever is earlier. She will be entitled for an additional remuneration @ 20% of her basic pay not exceeding Rs. 12,000/- pm in terms of existing instructions of the Finance Division.

This issues with the approval of Secretary, Revenue, Division.

MUHAMMAD UMAR,
Deputy Secretary (Admn).

Islamabad, the 15th January, 2021

No. 1(44)/2020-Admn.—After availing one month LFP with effect from 14th December, 2020 to 12th January, 2021, Mrs. Madeeha Khattak, Section Officer (BS-18), Revenue Division has assumed the charge of post of Section Officer (Admn), Revenue Division on 13th January, 2021.

RUSTAM KHAN,
Section Officer.

(Economic Affairs Division)

Islamabad, the 11th January, 2021

No. 1(18)/EA/AI/2020.—In pursuance of Establishment Division's Notification No. F. 3-5-2020-E-2, dated 30th November, 2020 and Corrigendum dated 30th December, 2020 Mr. Muhammad Imran Khan, a BS-19 officer of the Postal Group, has relinquished charge of the post of Deputy Secretary, Economic Affairs Division, with effect from 30th November, 2020.

This Division's notification of even number dated 5th November, 2020 is hereby withdrawn *ab-initio*.

Islamabad, the 13th January, 2021

No. 1(1291)/EA/A-I/2014.—Mr. Hussain Ghani, Accounts Officer (DMS-III), is assigned with effect from 5th January,

2021, Current Charge of the higher post of Director of Accounts (Payment), DM Wing, Economic Affairs Division for a period of three months (90 days) or till the availability of regular incumbent of the post whichever is earlier. As per rules, he will be entitled to draw "Special Pay" equal to @ 20% of basic pay subject to a maximum of Rs. 12,000/- p.m whichever is less.

This issues with the approval of Secretary, Economic Affairs Division.

Islamabad, the 14th January, 2021

No. F. 1-1008/EA/AI/2005.—After availing one hundred twenty (120) days leave on full pay with effect from 15th September, 2020 to 12th January, 2021, granted to him *vide* this Division's notification of even number dated 1st September, 2020, Syed Naseer Ali, Director (Computer) (BS-19), (Personnel No. 50058314), Economic Affairs Division has resumed charge of the same post in this Division on 13th January, 2021.

No. 1(31)/EA/AI/2020.—Ms. Iqra Khan, Section Officer (BS-17), Economic Affairs Division is granted (90) days Maternity Leave on full pay from 11th January, 2021 to 10th April, 2021, outside the leave account, under the Revised Leave Rules, 1980.

On expiry of leave the officer is expected to resume charge of the same post in this Division, at Islamabad.

Islamabad, the 18th January, 2021

No. 1(17)/EA/AI/2019.—In pursuance of this Division's letter of even number dated 18th January, 2021, Mr. Arsalan Matloob, has relinquished the charge of the post of Accounts Officer (BS-18), Economic Affairs Division on 18th January, 2021.

No. 1-1279/EA/A-I/2013.—Mr. Zahoor Hussain, Superintendent (BS-17), is assigned with effect from 6th January, 2021, Current Charge of the higher post of Section Officer (Council), Economic Affairs Division for a period of three months (90 days) or till the availability of regular incumbent of the post whichever is earlier. As per rules, he will be entitled to draw "Special Pay" equal to @ 20% of basic pay subject to a maximum of Rs. 12,000/- p.m whichever is less.

This issues with the approval of Secretary, Economic Affairs Division.

No. 1(22)/EA/A-I/2019.—Mr. Mukhtar Hussain Shah, Superintendent (BS-16), is assigned with immediate effect, Current Charge of the higher post of Section Officer (F&A), is Economic Affairs Division for a period of three months (90 days) or till the availability of regular incumbent of the post whichever is earlier. As per rules, he will be entitled to draw "Special Pay" equal to 20% of basic pay subject to a maximum of Rs. 12,000/- p.m. whichever is less.

This issues with the approval of Secretary, Economic Affairs Division.

SAJID HUSSAIN ABBASI,
Section Officer (Admin-I).

MINISTRY OF HOUSING & WORKS

Islamabad, the 11th January, 2021

No. F. 1(7)/2019-Admn-I.—In pursuance of Controller General of Accounts, Islamabad Notification No. 504/ CGA/ Estt/P.T/Cadared-Posts/2020/AGPR, dated 23rd July, 2020 and with the approval of Secretary (H&W), upon promotion as Accounts Officer (BS-18) with effect from 20th May, 2020, Mr. Imran, Assistant Accounts Officer (BS-17) Ministry of Housing & Works is hereby relieved from his duties with immediate effect to join Ministry of Industries and Production as Accounts Officer (BS-18).

No. F. 1(7)/2019-Admn-I.—In pursuance of Controller General of Accounts, Islamabad Notification No. 918/ CGA/ Estt/PT/Cadared-Posts/AAO/2020, dated 30th November, 2020 Mr. Umar Bakhsh, Assistant Accounts Officer (BS-17) has joined Ministry of Housing & Works on 31st December, 2020.

No. F. 4(11)/79-Admn-I.—On appointment of Mr. Muhammad Sajjad as Protocol Officer (BS-17) in the Ministry of Housing & Works on recommendations of FPSC and subsequent assumption of the charge of Protocol Officer on 5th January, 2021, the current charge of the post of Protocol Officer (BS-17) entrusted to Mr. Muhammad Tahir Farooq Siddiqui, Assistant Private Secretary (BS-16), Ministry of Housing & Works is hereby discontinued with effect from 5th January, 2021.

No. F. 1(1)/2021-Admn-I.—On the recommendations of Federal Public Service Commission, Islamabad vide Communication No. 4-222/2019-R-FS-I, dated 8th December, 2020 and pursuant to Ministry of Housing & Works, Islamabad Memorandum No. 6(43)/2014-Admn-I dated 16th December, 2020, and subsequent relieving from Airport Security Force, Quetta vide their movement order No ASF/10-B/Admin/2021/2755, dated 1st January, 2021 & with the approval of Secretary (H&W), Mr. Muhammad Sajjad, Inspector (BS-16), Airport Security Force, Quetta has assumed the charge of the post of protocol Officer

No. F. 2(9)/2016-Admn-III.—With the approval of competent authority i.e. Secretary (H&W) the following postings/transfers in Pak. PWD are hereby made with immediate effect till further orders :-

S. No.	Name of Officers & Designation M/s.	From	To
1.	Mr. Haq Nawaz, Superintending Engineer, (Civil) (BS-19)	Central Civil Circle Pak. PWD, Sukkar	(QS) Section DG's Office Pak. PWD, Islamabad
2.	Mr. Atta Muhammad Shahani, Executive Engineer (Civil) (18)	On return from MCMC	Executive Engineer (Civil) (BS-18) Central Civil Division, Sukkar. He is also assigned Current Charge of the vacant post of Superintending Engineer (Civil) (BS-19), Central Civil Circle Pak PWD, Sukkar for a period of three months or till the posting of regular incumbent whichever is earlier.
3.	Mr. Aijaz Hussain Memon, Superintending Engineer, (Civil) (BS-19)	(QS), Section DG's Office, Pak. PWD, Islamabad	Superintending Engineer, (SR&C), DG's Office, Pak. PWD, Islamabad
4.	Mr. Muhammad Azam Zafar Superintending Engineer, (Civil) (BS-19)	Superintending Engineer, (Civil) (BS-19)/Staff Officer to the Chief Engineer (South) Pak. PWD, Karachi.	Central Civil Circle-II, Pak. PWD, Islamabad. Pak. PWD's Office Order No. AI-717/700 (1400)TP XV dated 6th November, 2020 withdrawn <i>ab-initio</i> .

(BS-17) in the Ministry of Housing & Works (Main) on 5th January, 2021.

Islamabad, the 14th January, 2021

No. F. 4(11)/79-Admn-I/Pension Cell.—In supersession of this Ministry's earlier notifications of even numbers dated 30th June, 2020 and 8th October, 2020, Mr. Tahir Farooq Siddiqui, Assistant Private Secretary (BS-16) Ministry of Housing & Works (Main), Islamabad shall stand retire from Government Service on 8th April, 2021 (A.N) on attaining the age of superannuation. His date of birth is 9th April, 1961.

Islamabad, the 19th January, 2021

No. F. 1(16)/2019-Admn-I.—In pursuance of Establishment Division, Islamabad Notification No. 11/ 16/ 2017-E-I, dated 22nd December, 2020, Mr. Sajid Mehmood Raja, has relinquished the charge of the post of Chief Finance and Accounts Officer in the Ministry of Housing & Works on 8th January, 2021.

No. F. 1(7)/2019-Admn-I.—In pursuance of this Ministry's notification of even number dated 11th January, 2021, Mr. Imran, has relinquished the charge of the post of Assistant Accounts Officer (BS-17) in the Ministry of Housing & Works on 11th January, 2021.

MUHAMMAD KAMRAN,
Section Officer (Admn-I).

Islamabad, the 12th January, 2021

No. F. 11(13)/2007-Admn-III.—In continuation of this Ministry's Notification No. F. 3(2)/2020-Admn-III dated 30th July, 2020 and with the approval of the competent/ appointing authority i.e. Secretary M/o. (H&W), Mr. Qamar Hayat, is hereby promoted on regular basis as Executive Engineer (Civil) (BS-18) with effect from 30th July, 2020 with the condition that he shall not perform his duties as "Professional Engineer".

Islamabad, the 13th January, 2021

No. F. 11(15)/90-Admn-III.—In continuation of this Ministry's notification of even number dated 1st January, 2020 and with the approval of competent authority/Secretary (H&W), Mr. Anwar-ul-Haq, Chief Engineer (BS-20), Pak. PWD, is posted as Joint Engineering Advisor, (BS-20) in M/o. Housing and Works, on deputation basis for a period of three years on standard terms and conditions with effect from 1st January, 2020.

Islamabad, the 20th January, 2021

No. F. 2(9)/2016-Admn-III.—With the approval of competent authority / Secretary (H&W) following postings/transfers are hereby made with immediate effect till further orders :-

S. No.	Name & Designation	From	To
1)	Mr. Muhammad Rashid, Superintending Engineer, (Civil) (BS-19)	Central Civil Circle Pak. PWD, Multan	Central Civil Circle, Pak. PWD, Sukkur. Current charge of the post of Chief Engineer (BS-20), Central Zone, Pak. PWD, Lahore assigned to the officer <i>vide</i> notification dated 26th November, 2020 is hereby discontinued. Moreover, current charge of the post of SE (BS-19), Central Civil Circle, Pak. PWD, Sukkur, assigned to Mr. Atta Muhammad Shahani <i>vide</i> notification dated 12th January, 2021 is also discontinued.
2)	Mr. Nadir Qayyum Superintending Engineer (Civil) (BS-19) Project Civil Circle, Pak. PWD, Lahore.	--	Current charge of the post of Chief Engineer (BS-20), Central Zone, Pak. PWD, Lahore is hereby assigned to the officer for a period of three months or till the posting of regular incumbent, whichever is earlier.

SYED ZEESHAN RAZA ZAIDI,
Section Officer (Admn-III).

MINISTRY OF HUMAN RIGHTS

Islamabad, the 15th January, 2021

No. F. 220(HH)/A-II.—This Ministry's notification of even number dated 8th January, 2021, relating to repatriation of Mrs. Huma Hilal, is hereby cancelled/withdrawn *ab-initio*.

2. The services of Mrs. Huma Hilal, Assistant Professor (BS-18), Colleges Higher & Technical Education Department Quetta, working on deputation basis in the National Institute of Special Education, Islamabad under the Directorate General of Special Education, Islamabad against the post of Deputy Director (BPS-18) is repatriated to her parent department *i.e.* Colleges higher & Technical Education Department Quetta, Government of Balochistan, on completion of her initial deputation period of three (03) years, with immediate effect.

2. This issues with the approval of the Secretary, Ministry of Human Rights, Islamabad.

Islamabad, the 18th January, 2021

No. F. 1(5)/2020-Admn.—The competent authority *i.e.* Secretary, Ministry of Human Rights has been pleased to accept the resignation tendered by Ms. Maham Liaqat, Assistant Director (BS-17) in the project titled "Strengthening of Ministry of Human Rights" with effect from 28th January, 2021.

Islamabad, the 19th January, 2021

No. F. 1-56/2012-Admn.—Mr. Muhammad Ali Khan Mazari, Deputy Director (HR-I) BS-18 is granted current charge of the post of Director (BS-19) Regional Office, Human Rights, Lahore during the leave period of Ms. Lubna Mansoor, Director with effect from 1st January, 2021 to 10th May, 2021.

2. This issues with the approval of the Secretary, Ministry of Human Rights, Islamabad.

No. F. 1-56/2012-Admn.— Ms. Lubna Mansoor, Director, Regional Office, Human Rights, Lahore has been granted (130 days) one hundred and thirty days "Special Leave" (Iddat) from 1st January, 2021 to 10th May, 2021.

2. This issues with the approval of the Secretary, Ministry of Human Rights, Islamabad.

No. F.12(48)/2011-Admn.—Ms. Rukhsana Omer, Assistant Director (BS-17) after availing 17 Months Study Leave with effect from 31st July, 2019 to 31st December, 2020 has assumed the charge of the post of Assistant Director (BS-17), in the Ministry of Human Rights on 1st January, 2021.

This issues with the approval of Secretary, Ministry of Human Rights, Islamabad.

MARYAM ASLAM,
Section Officer (Admin).

MINISTRY OF INDUSTRIES AND PRODUCTION

(Industries and Production Division)

Islamabad, the 12th January, 2021

No. F.4(8)2020-Admn-III.—In continuation of this Division's notification of even number dated 8th December, 2020, the additional charge of the post of Chief Executive Officer (CEO), Pakistan Stone Development Company (PASDEC) is assigned to Joint Secretary (MED), Industries and Production Division, with effect from 23rd December, 2020 to 7th March, 2021 or until the appointment of regular CEO whichever is earlier.

Islamabad, the 14th January, 2021

No. 2(14)/99-Admn-I.—In pursuance of Cabinet's Decision in case No. 196/22/99, dated 23rd November, 1999, Dr. Hamid Ateeq Sarwar, Additional Secretary-II, has been designated as the Spokesperson of Industries and Production Division in place of Capt. (Retd.) Sher Alam Mahsud, Additional Secretary. His contract details are as under:

Office	9206674
Office Fax No.	9201212
Mobile No.	0300-4374077
E-Mail Address:	hamidateeq@gmail.com

Islamabad, the 20th January, 2021

No. 1(18)/2015-Admn-I.—In pursuance of Establishment Division's Notification No. 39/1052/2017-E-1, dated 18th January, 2021, Mr. Nadeem Ahmad Malik, a BS-20 officer of Secretariat Group has relinquished the charge of the post of Joint Secretary BS-20 in the Industries and Production Division with effect from 19th January, 2021.

This issues with the approval of the Secretary, Industries and Production Division.

No. 1(18)/2015-Admn-I.—Mr. Waqar ud Din Siddiqui, Joint Secretary (IF) is hereby granted additional charge against the post of Joint Secretary (MED) with effect from 20th January, 2021 for a period of 03 months or till the availability of regular officer whichever is earlier.

The officer is entitled to draw special remuneration @ 20% of his basic pay subject to maximum up to Rs. 12,000 whichever is less.

This issues with the approval of the Secretary, Industries and Production Division.

OMER MANZOOR SHEIKH,
Section Officer (Admn-I).

Islamabad, the 18th January, 2021

No. 6-4/2002-USC-I.—The Federal Government, *vide* decision of the Cabinet in Case No.37/02/2021 dated 12th January, 2021, is pleased to dissolve the existing Board of Directors of Utility Stores Corporation of Pakistan (Pvt) Ltd. in terms of Section 165 (3) read with Sections 164 (1) and 165 (1) (b) of the Companies Act, 2017, with immediate effect.

No. 6-4/2002-USC-II.—The Federal Government, *vide* decision of the Cabinet in Case No.37/02/2021 dated 12th January, 2021, is pleased to constitute a new Board of Directors (BoD) of Utility Stores Corporation of Pakistan (Pvt) Ltd. comprising the following *ex-officio* Directors, for the time being with immediate effect, in terms of Section 164 (1) read with Section 165 (1) (b) of the Companies Act, 2017:-

i.	Secretary, Industries and Production Division, Islamabad	Director
ii.	Joint Secretary (A&F), Industries & Production Division, Islamabad	Director
iii.	Joint Secretary (Corporate Finance), Finance Division, Islamabad	Director
iv.	Director General (NSER), Benazir Income Support Programme	Director
v.	Managing Director, Utility Stores Corporation of Pakistan	Director
vi.	Director General, Federal Investigation Authority (FIA) or their nominee (as Co-opted Member on need basis)	Director

2. Federal Government *vide* the aforementioned decision of the Cabinet is further pleased to appoint Secretary, Industries and Production Division, Islamabad,

as Chairman of the BoD of Utility Stores Corporation of Pakistan (Pvt) Ltd. in accordance with Rule 4(4) of Public Sector Companies (Corporate Governance) Rules, 2013, for a period of three months or till the appointment of a new Chairman BoD, whichever is earlier.

AYESHA FARZAND ALI,
Section Officer (USC).

the Revised Leave Rules, 1980. (His date of birth was 11th September, 1961).

This issues with the approval of Secretary NH&C Division.

ABDUL RAUF,
Section Officer (Org-IV).

MINISTRY OF INFORMATION, BROADCASTING AND
NATIONAL HERITAGE

Islamabad, the 12th January, 2021

No. F.2(3)/2015-P-II.—On the recommendation of Departmental Promotion Committee held on 12th January, 2021, the Secretary Ministry of Information and Broadcasting being Appointing Authority in terms of Rule 6 of Appointment, Promotion and Transfer Rules, 1973, has approved the promotion of Mr. Mazhar Hanif, Inspector (BS-17) Implementation Tribunal for Newspaper Employees (ITNE), Islamabad to the post of Registrar (BS-19), in the said department with effect from 7th February, 2019.

He will be on probation for a period of one year from the date of actualization of his promotion.

OMER KHAN,
Deputy Director (P-II).

(National Heritage & Culture Division)

Islamabad, the 11th January, 2021

No. F.1(8)/2017-NLP.—Syed Ghyour Hussain, Director (HRDC) (BS-19) of the National Library of Pakistan (NLP), Islamabad, is granted current charge against the vacant post of Director General (Chief Librarian) (BS-20), NLP, with immediate effect, for a period of 03 months or till availability of regular incumbent, whichever is earlier. He will be entitled to the financial benefits as admissible under the rules.

The incumbent of the post is allowed to exercise administrative/financial powers, as Head of Department, as delegated under the System of Financial Control and Budgeting-2006, issued by the Finance Division *vide* O.M. F. 3(2)-Exp-III/2006, dated 13th September, 2006.

This issues with the approval of Secretary, NH & Culture Division/Principal Accounting Officer.

Islamabad, the 12th January, 2021

No. F.4-26/2020-USB.—Mr. Faizan Ullah Khan (Late), Research Officer (BPS-17), Urdu Science Board, has died on 7th November, 2020 during service at Urdu Science Board Lahore Leave encashment of LPR for a period of 365 days is due to him in the light of Rule-18-A of

MINISTRY OF INFORMATION TECHNOLOGY &
TELECOMMUNICATION

Islamabad, the 18th January, 2021

No. F.1-2/2020-IT.—Consequent upon his contract appointment as Senior Manager (Governance) in PPS-9 under the Project titled. "Project Monitoring and Digital Transformation Cell" Mr. Hassan Ali Khan has joined his duties with effect from 27th November, 2020 with same terms and conditions as laid down in the original offer letter.

No. F.3-5/2020-TDP.—The Secretary IT & Telecom, is pleased to extend the contract period of Syed Fauad Haider Naqvi, Senior Manager of the Project titled "Technology Park Development" with effect from 3rd February, 2021 for a period of one year with the same terms and conditions as laid down in the original offer letter.

NASEEM A. KHAN ABBASI,
Deputy Secretary (Dev).

MINISTRY OF INTERIOR

Islamabad, the 11th January, 2021

No. 5/27/2020-Admn-I.—In pursuance of this Ministry's O.M. No. 5/27/2020-Admn-I, dated 15th December, 2020, Ms. Sadia Haider, (BS-18/PAS) has assumed the charge of the post of Section Officer, Interior Division on 17th December, 2020.

This issues with the approval of the Secretary Interior.

Islamabad, the 19th January, 2021

No. 5/1/2021-Admn-I.—In pursuance of Establishment Division's Notification No. 11/16/2017-E-I, dated 22nd December, 2020, Mr. Sajid Mehmood Raja, a BS-19/PA&AS officer has assumed the charge of the post of Chief Finance & Accounts Officer (CF&AO), Interior Division on 8th January, 2021.

Islamabad, the 20th January, 2021

No. 5/2/2021-Admn-I.—In pursuance of approval of the competent authority *i.e.* Secretary Interior and on having been relieved from Ministry of Railways Mr. Mati ul Haq, Assistant (BS-16), Ministry of Railways, Islamabad transferred/posted on deputation basis under Section 10

of CSA, 1973 for a period of three (03) years with effect from 13th January, 2021 on standard terms and conditions to Ministry of Interior against the vacant post of BS-17.

ABDUL RAZAQ,
Section Officer (Admn-I).

Islamabad, the 11th January, 2021

No. F.3-38/2020-CDA-III.—Consequent upon approval of competent authority *i.e.* Secretary, Ministry of Interior and *vide* Ministry of Information and Broadcasting's O.M. dated 23rd December, 2020, the services of Mr. Asif Ali Raza Shah, a BS-18 officer of the Information Group, presently posted as Deputy Director, Regional Information Office, Press Information Department, Karachi has been placed at the disposal of CDA as Director Public Relations (BS-18/19) on deputation basis, on standard terms and conditions, with immediate effect.

RASHID AHMAD,
Section Officer (CDA-III).

Islamabad, the 14th January, 2021

No. 3/2/2020-FC(KP)South.—Mr. Asmat Ullah Khan, Superintendent is hereby promoted as Assistant Record Officer (BPS-17) in Headquarters Frontier Corps KP (South), D.I. Khan with effect from 21st December, 2020.

No. 3/2/2020-FC(KP)South.—Mr. Taj Ali Khan, Superintendent is hereby promoted as Accounts Officer (BPS-17) in Headquarters Frontier Corps KP (South), D.I. Khan with effect from 21st December, 2020.

MUHAMMAD HASSAN,
Section Officer (FC).

Islamabad, the 12th January, 2021

No. 1/6/2020-F.Con.—Consequent upon the approval of Ministry of Interior, *ex-Pakistan* leave for thirty (30) days with effect from 1st January, 2021 in respect of Mr. Muhammad Imran Sethi, (PSP/BS-18), District Officer, (Training & Coordination), Frontier Constabulary, Islamabad is cancelled, Furthermore, this Ministry's notification of even number dated 16th December, 2020 is hereby withdrawn.

ZAKYA RUBAB,
Section Officer (F. Con).

Islamabad, the 14th January, 2021

No. 1/6/2020-F.Con.—Consequent upon the approval of Ministry of Interior, Rana Hussain Tahir (PSP/BS-17), Assistant District Officer, Frontier Constabulary, Islamabad is granted *ex-Pakistan* leave for Twenty Two (22) days from 26th February, 2021 to 19th March, 2021.

SHOUKAT ALI KHAN,
Section Officer (F.Con).

Islamabad, the 15th January, 2021

No. No.(II)/2021.—Pursuant to the request made by the Election Commission of Pakistan, Islamabad *vide* Letter No. F. 6(PS-52)/2020-Elec-II dated 4th January, 2021, the Federal Government, in exercise of powers conferred under Sections 4 & 5 of the Anti-terrorism Act, 1997, is pleased to authorize deployment of 640 troops of Pakistan Rangers (Sindh) outside all polling stations in the constituency of PS-52 Umerkot-II, from 17th January, 2021 to 19th January, 2021, for conduct of by-elections.

Islamabad, the 19th January, 2021

No. 9/1/2014-R (Punjab).—Pursuant to the request by the Chief Commissioner, Islamabad Capital Territory under section-4 (2) of Anti-Terrorism Act, 1997 (as amended) the Federal Government, in exercise of powers under clause (i) of sub-section (3) of Section-4 of Anti-Terrorism Act, 1997 (as amended), is pleased to authorize deployment of Pakistan Rangers troops (3 x Wings & 1 x Sector HQs) already stationed in Islamabad Capital Territory (not exceeding 2000 troops) and 50 troops of Gilgit-Baltistan Scouts, already stationed in Islamabad to discharge such functions as specified in the said Act or as may be authorized by the Chief Commissioner with effect from 20th April, 2020 to 21st June, 2021.

ANAM JAMAL,
Section Officer (Rangers).

MINISTRY OF INTER PROVINCIAL COORDINATION

Islamabad, the 12th January, 2021

No. F.1-7/2007-Admn-I.—With the approval of Secretary, Ministry of IPC, Mr. Sajid Majeed, Superintendent (BS-17) is allowed to hold current charge of the post of Section Officer (B&A) (BS-17) in addition to his own duties for a period of 03-months (90-days) with effect from 1st January, 2021 or till the availability of regular incumbent, whichever is earlier. He will be entitled to draw additional remuneration as admissible under the rules.

Islamabad, the 13th January, 2021

No. F.1(684)/2021-Admn-I.—In pursuance to Establishment Division's Notification No. 11/16/2017-E-I dated 22nd December, 2020, Syed Ishtiaq Ur Rehman, a BS-20 Officer of Pakistan Audit & Accounts Service (PA&AS), has assumed the charge of the post of Chief Finance & Accounts Officer (BS-20), Ministry of Inter Provincial Coordination, as 11th January, 2021.

Islamabad, the 14th January, 2021

No. F.2-10/2010-Admn-I.—With the approval of competent authority *i.e.* Secretary, Ministry of IPC, Syed Mudassar Hussain Shah, APS (BS-16) is allowed to hold current charge of the post of Section Officer (CCI) (BS-17) in addition to his own duties for a period of 03-months (90-days) with effect from 18th December, 2020 or till the transfer of CCI Wing from Ministry of IPC, whichever is earlier. He will be entitled to draw additional remuneration as admissible under the rules.

Islamabad, the 18th January, 2021

No. F.1(685)/2021-Admn-I.—In pursuance to Establishment Division's Notification No. PF.1419/2018-E-VII dated 12th January, 2021, Mr. Shakil Ahmed, Section Officer (BS-17/OMG) has assumed the charge of the post of Section Officer (BS-17), in Ministry of IPC on 14th January, 2021.

Islamabad, the 20th January, 2021

No. F.2-10/2010-Admn-I (pt).—With the approval of competent authority *i.e.* Secretary, Ministry of IPC, Mr. Mazhar Hussain, Section Officer (BS-18) is allowed to hold current charge of the post of Deputy Secretary (T&R) (BS-19) in addition to his own duties for a period of 03-months (90-days) with effect from 13th January, 2021 or till the joining back of regular incumbent, whichever is earlier. He will be entitled to draw additional remuneration as admissible under the rules.

FARHAN AKHTAR,
Section Officer (Admn-I).

Islamabad, the 13th January, 2021

No. F.1-208/2011-Admn.—Mr. Nazir Ahmad Abbasi, Assistant Private Secretary (BS-16), Ministry of Inter Provincial Coordination, Islamabad is granted encashment of 365-days pay in lieu of 365-days LPR with effect from 13th January, 2021 to 12th January, 2022 in pursuance of Finance Division (Regulations Wing)'s Notification No.F.1(7)R-4/2004 (SRO-70 (KE)/2012), dated 29th August, 2012.

The officer will stand retired from Government Service with effect from 13th January, 2022 on attaining the age of superannuation.

This issues with the approval of Senior Joint Secretary (Admn), Ministry of IPC.

MUHAMMAD MOTASIM BILLAH,
Section Officer (Admn-II).

MINISTRY OF KASHMIR AFFAIRS AND
GILGIT-BALTISTAN

Islamabad, the 13th January, 2021

No. F.6(1)-Admn/2019.—In pursuance of Establishment Division's Notification No. PF (592)/E-5 (PAS) dated 7th January, 2021, the current charge of the post of Secretary (BS-22), Kashmir Affairs and Gilgit-Baltistan Division granted to Lt. (Retd.) Mr. Ejaz Ahmad Khan, Additional Secretary (BS-21), Ministry of Kashmir Affairs and Gilgit-Baltistan is extended for a further period of three months with effect from 19th October, 2020 or till the posting of a regular incumbent, whichever is earlier.

Islamabad, the 15th January, 2021

No. F.15(13)-Admn/2005.—With the approval of Secretary, KA&GB, Mr. Shabbir Khan Baloch, Section Officer (B&C) has been assigned the additional charge of the vacant post of Section Officer (GA) with effect from 17th December, 2020 for a period of three months or till the posting of a regular incumbent by the Establishment Division, whichever is earlier.

Islamabad, the 19th January, 2021

No. F.6(1)-Admn/2021.—In pursuance of Establishment Division's Notification No. PF 1003/2011-E-VII dated 16th October, 2020, Mrs. Rabia Mohsin, a BS-18 Officer of Office Management Group has assumed the charge of the post of Section Officer (BS-18) in the Ministry of Kashmir Affairs & Gilgit-Baltistan on 1st January, 2021.

HAMID MAHMOOD RANA,
Deputy Secretary.

[GILGIT-BALTISTAN COUNCIL SECRETARIAT]

Islamabad, the 14th January, 2021

No. F.1(9)/2013/F-II-GBC.—In pursuance of this Secretariat's notification of even number dated 10th November, 2020, Mr. Umar Ali Khan, a BS-20 officer of Pakistan Audit & Accounts Service, has assumed the charge of the post of Accountant General Gilgit-Baltistan on 26th November, 2020.

No. 1(14)-AO/2015/F-II-GBC.—Consequent upon the recommendations of Departmental Promotion Committee (DPC), the Secretary-in-charge Gilgit-Baltistan Council is pleased to approve the promotion of Mr. Amin Ashraf,

Assistant Accounts Officer (BS-17) to the post of Accounts Officer (BS-18) in the office of Accountant General Gilgit-Baltistan with immediate effect.

The officer will be on probation for a period of one year.

SUDHER KHAN KHATTAK,
Deputy Secretary (Finance).

MINISTRY OF LAW AND JUSTICE

(Law and Justice Division)

Islamabad, the 12th January, 2021

No. F.33(5)/2011-A.III.—With the approval of the competent authority, the additional charge of the vacant post of Assistant Private Secretary (BS-16), Banking Court-II, Lahore is hereby entrusted to Mr. Usman Gulfam, Assistant Private Secretary (BS-16), Commercial Court Lahore in addition to his own duties, with effect from the date of assumption of its charge for a period of three months or till the appointment of regular incumbent whichever is earlier, alongwith additional charge allowance as admissible under the rules.

No. F.24(13)/1997-A-III (Vol-III).—Pursuant to this Division's Notification No. F. 24(15)/1997-A-III (Pt) dated 2nd December, 2020, Mr. Atiq-ur-Rehman, District and Sessions Judge has assumed the charge of the post of Judge, Banking Court-II, Multan with effect from 14th December, 2020. He is also authorized to exercise DDO powers of the said Court.

Islamabad, the 14th January, 2021

No. F.31(1)/91-A.III (Pt).—The competent authority has been pleased to grant six (06) days leave on full pay (L.F.P.) with effect from 4th January, 2021 to 9th January, 2021 to Mr. Nasrullah Khan Gandapur, Chairman, Drug Court, Peshawar on account of his illness.

On expiry of leave the Officer is likely to resume his duties on the same post and station.

Islamabad, the 20th January, 2021

No. F.24(14)/97-A.III(Vol-IV).—With the approval of the competent authority, the additional charge of the vacant post of Judge, Banking Court-III, Multan is entrusted to Mr. Abid Hussain, Judge Banking Court-I, Multan, along with DDO powers in addition to his own duties for a period of three months with effect from date of assumption of charge of the post or till the appointment of regular incumbent, whichever is earlier, along with additional charge allowance as admissible under the Rules.

MUHAMMAD RAZAULLAH LAKHO,
Section Officer (A-III).

Islamabad, the 20th January, 2021

No. F.3(1)/2015-Admn.V.—With the approval of the competent authority, Mr. Muhammad Bashir, Judge, Accountability Court-I, Islamabad is hereby granted 18 days quarantine leave with effect from 5th January, 2021 to 22nd January, 2021 on medical grounds.

FAISAL MALIK,
Section Officer (A-V).

Islamabad, the 11th January, 2021

No. F.13(1)/2019-A-IV.—In pursuance of Law and Justice Division's notification of even number dated 31st December, 2020 Mr. Justice (Retd.) Qalandar Ali Khan has assumed the charge of the post of Chairman, Medical Tribunal, Islamabad with effect from 4th January, 2021.

ALI HASNAIN BUKHARI,
Section Officer.

[LAW AND JUSTICE COMMISSION OF PAKISTAN]

Islamabad, the 11th January, 2021

CORRIGENDUM

No. F.14/119/94/LJC-AI.—This Secretariat notification of even number dated the 19th June, 2020, the mandate of the following Departmental Selection/Promotion Committee may be read as to make recommendations for appointments to the posts in BPS-16 and above in the LJCP Secretariat as provided under Rule 8 of the Law and Justice Commission of Pakistan (Terms and Conditions of Service) Rules, 1992:-

(i)	Hon'ble Mr. Justice Mushir Alam, Judge, Supreme Court of Pakistan	Chairman
(ii)	Hon'ble Mr. Justice Umar Ata Bandial, Judge, Supreme Court of Pakistan.	Member
(iii)	Hon'ble Mr. Justice Mian Shakirullah Jan, Former Judge Supreme Court of Pakistan/ Member LJCP.	Member
(iv)	The Registrar, Supreme Court of Pakistan	Member
(v)	The Secretary, Ministry of Law and Justice	Member
(vi)	The Secretary, Law and Justice Commission of Pakistan	Member

Islamabad, the 15th January, 2021

No. F.12/278/2018/LJC-A.—In continuation of this Secretariat notification of even number dated the 15th January, 2020, the Hon'ble Chief Justice of Pakistan / Chairman, Law and Justice Commission of Pakistan *i.e.* the competent authority has been pleased to extend the contractual appointment of Dr. Muhammad Raheem Awan as Secretary (BPS-21), Law and Justice Commission of Pakistan (LJCP) for further period of three months with effect from 18th January, 2021 on the terms and conditions as contained in this Secretariat Letter No.DS-Admin/2017/LJCP, dated 23rd December, 2017.

RAJA MUHAMMAD FAISAL IFTIKHAR,
Deputy Secretary (Admin).

MINISTRY OF MARITIME AFFAIRS

Islamabad, the 11th January, 2021

No. F.2(48)/18-Fish.—In pursuance of Cabinet Division's Memorandum No.01/CM/2021-D, dated 8th January, 2021, Federal Government is pleased to constitute the following Inspection Committee under Section 5(1) of Pakistan Fish Inspection and Quality Control Act, 1997, for Registration of Fish Processing Plants with immediate effect:-

Sr. No.	Name	Designation
1	Director General, Marine Fisheries Department, Karachi	Chairman
2	Director, Agro and Food Division, Trade Development of Pakistan (TDAP)	Member
3	Chairman, Pakistan Fisheries Exporter Association (PAKFEA)	Member

KHIZAR SALEEM KHOKAR,
Deputy Secretary-I.

[PORTS & SHIPPING WING]

Karachi, the 13th January, 2021

No. 17(10)/2019-Estt.—With the approval of competent authority, Ms. Aeyman Zehra, Section Officer (Coord/BS-17), Ports and Shipping Wing, Karachi has been granted sixty (60) days leave on full pay (LFP) with effect from 13th January, 2021 to 13th March, 2021.

On expiry of the above leave the officer shall resume the charge on the same post and at the same station.

No. 13(04)/2019-Estt.—With the approval of competent authority Ms. Sarah Shahid, Section Officer (P-I/BS-17), Ports and Shipping Wing, Karachi has been granted sixty (60) days leave on full pay (LFP) with effect from 13th January, 2021 to 13th March, 2021.

On expiry of the above leave the officer shall resume the charge on the same post and at the same station.

ALI MUHAMMAD,
Section Officer (Estt).

MINISTRY OF NATIONAL FOOD SECURITY &
RESEARCH

Islamabad, the 7th January, 2021

No. F.1-10/2013/DFSC-II/Seed-Laws.—In pursuance of the approval of the worthy Secretary, M/o. NFS&R, the following committee are constituted for technical and administrative audit of FSC&RD:-

a)	Food Security Commissioner-II	Convener
b)	Economic Consultant	Member
c)	Food Security Commissioner-I	Member
d)	Director General, API	Member
e)	Director General, FSC&RD	Member/ Secretary

TORs:

- Identification of gap between existing capabilities and requirements of FSC&RD.
 - Work flow process; work efficiency and responsiveness.
 - Key technical issues including SOPs, IT infrastructure, MIS, regulatory regime, enforcement *etc.*
 - Administration structure; HR role and responsibilities.
 - Any other task related or incidental to above.
2. The Committee will submit its initial report within 2 months.

Subject: PRIME MINISTER'S PACKAGE FOR RABI CROPS SPECIALLY WHEAT

No. F.9-4/2020-EW/NFS&R.—The Federal Government, through Economic Coordination Committee (ECC) of the Cabinet in its meeting held on 29th October, 2020 *vide* Case No.ECC's Case No.402/52/2020 approved the Prime Minister's Package for Rabi Crops Specially Wheat at the tune of Rs.5.4 billion. The following mechanism was developed in consultation with relevant stakeholders.

- The scheme is applicable to all four provinces of Pakistan.
- Federal and Provincial Government would contribute at the ratio of 70% and 30% respectively to provide subsidy on DAP and other P&K fertilizers @ Rs.1000 per 50 KG bag.

- c. Federal Government would contribute 100% funds to provide subsidy on weedicides @ Rs.250 per acre and fungicides @ 150 per acre.
- d. In the absence of a common system of subsidy disbursement, each province may adopt its prevailing system, provided it ensures transparency and delivers subsidy benefits to the farmers. In the case of Government of Punjab, the E-voucher scheme, which is relatively best, would be used to disburse the subsidy. Likewise, in KP, the subsidy would be distributed through coupon system, Government of Sindh and Baluchistan would be approached and asked to follow suit and use the facility.
- e. The Federal funds for subsidy shall be directly disbursed to the Provinces by the Finance Division on the basis of their share calculated, keeping in view their system strength and overall outreach.
- f. The Provincial Governments would submit their demand for funds to the MNFS&R. The MNFS&R would examine the provincial demand, funds utilization reports and recommend further of funds to the Provinces to the Finance Division. Finance Division, on the recommendations of MNFS&R shall transfer the funds to the Provinces.
- g. Provinces would expand, improve and up-grade their subsidy disbursement systems. The Provincial Governments would also be responsible to fulfill all codal formalities, keep record for audit and submit quarterly reports to the MNFS&R.

2. Benchmarking the existing outreach of Punjab E-Voucher scheme for all the Provinces, which is 13% of the total registered farmers in Punjab, and to incentivize the Provincial Governments to further expand and maximize their outreach to the farmers, an amount of Rs.5.4 billion as Federal share for Rabi Crops, calculated on the basis of 30% of provincial outreach has been approved.

3. In order to meet incidental expenditures for implementing the fiscal & Rabi package, an amount of Rs.500 million has been approved from within the allocated resources to cater for the administrative and advertisement cost related to fertilizer, whitefly pesticide, cotton seed weedicides and fungicides subsidies for MNFS&R & Provincial level (MNFS&R =Rs.200 million. Punjab =150 million, Sindh =Rs.75 million, KP = Rs.50 million and Baluchistan =Rs.25 million).

4. The implementation of the package is effective from 5th December, 2020.

Islamabad, the 15th January, 2021

No. F.8-1/2012-Admn-II(DPP).—Mr. Allah Ditta Abid, Director Technical (BS-19), Department of Plant Protection, Ministry of National Food Security and Research is

assigned current charge of the post of Director General (BS-20), Department of Plant Protection, Karachi with immediate effect for a period of three months or till the availability of regular incumbent whichever is earlier.

This issues with the approval of competent authority.

QASIM KHAN KHATTAK,
Deputy Secretary (Admn).

Islamabad, the 11th January, 2021

No. F.1-34/2015-Admn-I.—In pursuance of Agriculture Policy Institute Notification No.F.2(31)Estt/95 dated 5th January, 2021, Mr. Muhammad Azeem Hakro, Deputy Chief, Agriculture Policy Institute, M/o. NFS&R has assumed the charge of the post of Deputy Agricultural Development Commissioner (BS-19) in the Ministry of National Food Security and Research with effect from 5th January, 2021 on deputation basis on standard terms and conditions.

This issues with the approval of the Secretary, Ministry of National Food Security and Research.

Islamabad, the 19th January, 2021

No. F.3-13/82-Admn-I.—Mr. Gulzameer Qureshi, Private Secretary (BS-18) of the Ministry of National Food Security and Research, is allowed encashment equal to 365 days pay in lieu of 365 days leave Preparatory to Retirement (LPR) on full pay from 2nd January, 2021 to 1st January, 2022, as admissible under rule 18-A of the Revised Leave Rules, 1980.

On attaining the age of superannuation *i.e.* 60 years, he shall stand retired from Government Service with effect from 1st January, 2022.

No. F.2-6/2018-Admn-I.—In pursuance of Establishment Division's Notification No.PF.1412/2017-E-VII dated 14th January, 2021, Ms. Ambreen Ashfaq, Section Officer (OMG/BS-17) has relinquished the charge of the post of Section Officer (BS-17) in the Ministry of National Food Security and Research, Islamabad with effect from 15th January, 2021.

No. F.2-4/2001-Admn-I.—In pursuance of Office of the Inspector General of Police, National Highways and Motorway Police Notification No.NH&MP-70(2)/2020/44 dated 15th January, 2021, Mr. Iftikhar Ahmed, Assistant Private Secretary (BS-16) is hereby relieved and his services are placed at the disposal of National Highway and Motorway Police, on deputation basis on standard terms and conditions, with immediate effect.

DR. AKHTAR ALI HAKRO,
Section Officer.

Islamabad, the 19th January, 2021

No. F.1-3/2019/DFSC-II/Wheat/Import.—Pursuant to the decision of the Economic Coordination Committee (ECC) of the Cabinet No.ECC-413/55/2020 dated 6th November, 2020 and ratification of the Cabinet Division in Case No.872/44/2020 dated 10th November, 2020 regarding "Issue related to demand and supply of wheat", the following decisions are notified for implementation with immediate effect till further orders:-

- i. Approved Rs.1650/40 Kg as Minimum Support Price (MSP) for wheat crop, 2020-21.
- ii. Approved Rs.1475/40 Kg as Release Price for current year.
- iii. Approved additional import of wheat of 0.40 MMT for Punjab by the TCP by waiving off all prevalent taxes and duties on the import of wheat.
- iv. Approved Grinding ratio at least at the level of 70:30.
- v. Approved aggregate release of wheat minimum @ 38,000 MT per day to the flour mills with the breakup as 25,000 MT by Punjab, 8,000 MT by Sindh, 4,000 MT by Khyber Pakhtunkhwa and 1,000 MT by Balochistan.

MUHAMMAD AZEEM HAKRO,
Deputy Agric. Development
Commissioner-II.

[FEDERAL WATER MANAGEMENT CELL]

Islamabad, the 20th January, 2021

No. F.1-10/95-Estt(WM).—Consequent upon approval of the Director General (WM), Mr. Muhammad Hanif Kandhro, Research Officer (BS-17), Federal Water Management Cell is granted seven (07) days leave on full pay with effect from 9th January, 2021 to 15th January, 2021.

On expiry of above leave, he has resumed his duty on the same post and station.

TEHMEENA IQBAL,
Research Officer (Admn).

MINISTRY OF NATIONAL HEALTH SERVICES,
REGULATIONS & COORDINATION

Islamabad, the 6th January, 2021

No. F.3-228/2020-Estab-III.—In pursuance of Establishment Division's Notification No.F.1/195/2020-E-4 dated 7th December, 2020 and with the approval of

competent authority in Ministry of National Health Services, Regulations & Coordination (NHSR&C), Ms. Raheela Ghaffar, Pharmacist (BS-17), Health Department, Government of Balochistan, Quetta is posted as Pharmacist (BS-17) in Pakistan Institute of Medical Sciences (PIMS), Islamabad on deputation basis under wedlock policy for an initial period of three (3) years or till the availability of regular incumbent of the post, whichever is earlier, on standard terms and conditions with immediate effect.

Islamabad, the 7th January, 2021

No. F.10-408/2020-Estab-III.—With the approval of the Cabinet as conveyed *vide* Cabinet Division's Memorandum No.Dy.1044(S)/2020-Cab dated 29th December, 2020 the following institutions (Hospitals) have been added in the Schedule of Federal Medical Teaching Institutes Ordinance, 2020 (Ordinance No.XII of 2020):-

1. Sheikh Zayed Postgraduate Medical Institute (SZPGMI), Lahore
2. Jinnah Postgraduate Medical Centre (JPMC), Karachi
3. National Institute of Cardiovascular Diseases (NICVD), Karachi
4. National Institute of Child Health (NICH), Karachi

No. F.1-385/2014-Estab-III.—Competent Authority *i.e.* Secretary, NHSR&C has been pleased to terminate the probation period of Dr. Muhammad Iqbal Durrani, Deputy Executive Director (BS-19), Pakistan Institute of Medical Sciences (PIMS), Islamabad with immediate effect.

No. F.3-219/2020-Estab-III.—In pursuance of Establishment Division's Notification No.1/69/2020-E-4 dated 16th December, 2020 and with the approval of competent authority, Ministry of National Health Services, Regulations & Coordination (NHSR&C), Dr. Sadia Gulzar, Women Medical Officer (BS-17), Health Department, Government of Khyber Pakhtunkhwa is posted as Medical Officer (BS-17), Distract Health Office (DHO), Islamabad on deputation basis under wedlock policy for an initial period of three (3) years on standard terms and conditions with immediate effect or till the availability of a regular incumbent against the post, whichever is earlier.

ZAFAR IQBAL,
Deputy Secretary (Tech-I).

Islamabad, the 6th January, 2021

No. PF.18-61/Med/NM/Admn-I.—In pursuance of this Ministry notification of even number dated 18th November, 2020, Mr. Naseer Mohiuddin, Director General (Technical) (BS-20) has relinquished the charge of the post of Director General (Technical) (BS-20), Ministry of National Health

Services, Regulations and Coordination with effect from 29th December, 2020 upon his retirement on attaining age of superannuation.

No. PF.10(23)SH/2018(Admn-I).—In pursuance of this Ministry's Notification No.10(23)SH/2018(Admn-I) dated 31st December, 2020, Mr. Shoab Hasan has assumed the charge of the post of Section Officer (BS-17) in Ministry of National Health Services, Regulations & Coordination with effect from 1st January, 2021.

No. F.12-22/2019-Admn-I.—Mr. Zia-ur-Rehman, Assistant (BS-16), Ministry of National Health Services, Regulations and Coordination is assigned the current charge of the post of Superintendent (BS-16) with immediate effect for a period of three months or till posting of a regular incumbent, whichever is earlier.

This issues with the approval of Joint Secretary (Admn & Finance), M/o. NHR&C.

Islamabad, the 7th January, 2021

No. F.9-1/2020-S.O(T/FA).—With the approval of competent authority *i.e.* Secretary M/o. National Health Service, Regulations & Coordination, Islamabad, Dr. Irum Javed, Deputy Principal (BS-18) Regional Training Institute (RTI) Islamabad is granted current charge of the post of Principal (BS-19) Regional Training Institute (RTI), Islamabad with immediate effect for a period of three months or till the filling of the post on regular basis by promotion, whichever is earlier.

No. PF.21-1/2019-Admn-I.—In continuation of this Ministry's notification of even number dated 5th January, 2021, Dr. Rana Muhammad Safdar presently posted as Director General (Health) will continue to draw his salary from National Institute of Health (NIH), Islamabad,

FARHAN SIKANDAR,
Section Officer (Admn-I).

Islamabad, the 7th January, 2021

No. F.1-47/2015-Admn-IV.—Consequent upon the approval of Establishment Division *vide* O.M. No.1/85/2017-E-4, dated 16th December, 2020, Dr. Umer Farooq, Senior Medical Officer (BS-18), Health Department, Government of Khyber Pakhtunkhwa, Peshawar presently serving as Senior Scientific Officer (BS-18) in Allergy Centre (National Institute of Health), M/o. NHS, R&C is granted extension in deputation further from 1st June, 2020 to 31st January, 2022 on standard terms and conditions.

MUHAMMAD ASHRAF NASAR,
Section Officer (Admn-III).

MINISTRY OF NARCOTICS CONTROL

Islamabad, the 11th January, 2021

No. F.2/2/2000-ANF.—PA-53961 Captain Abdullah Bin Arif has relinquished the charge of the post of Assistant Director/ Staff Officer (BS-17), Headquarters Anti Narcotics Force, Rawalpindi with effect from 18th December, 2020.

MUHAMMAD HASSAN ABDULLAH,
Section Officer (ANF).

MINISTRY OF OVERSEAS PAKISTANIS & HUMAN
RESOURCE DEVELOPMENT

Islamabad, the 12th January, 2021

No. F.1(3)/2018-CWA-I.—With the approval of the competent authority, *i.e.* Secretary OP&HRD, Mr. Majid Hussain Memon (Economist/BS-18), Community Welfare Attache-II, Consulate General of Pakistan, Jeddah (KSA), has been granted nineteen (19) days *ex-country* leave on full pay from 10th January, 2021 to 28th January, 2021 with the permission to leave the station.

The officer will assume his duty at the same station and post after availing the above mentioned leave.

JUNAID AFZAL,
Section Officer.

Islamabad, the 13th January, 2021

No. F.2(2)/2021-Admn-I.—With the approval of Secretary, M/o. OP&HRD, Syed Qabil Shah, Superintendent (BS-17), has been given current charge of the post of Section Officer (BS-17) in this Ministry, in addition to his own duties with effect from 12th January, 2021, for a period not exceeding 90 days or till posting of a regular incumbent, whichever is earlier.

He is entitled to Special Pay @ 20% of his basic pay subject to maximum of Rs.12,000/- P.M. in terms of existing rules on the subject.

No. F.2(2)/2021-Admn-I.—With the approval of Secretary, M/o. OPS&HRD, Mr. Shaukat Ali, Superintendent (BS-17), has been given current charge of the post of Section Officer (BS-17) in this Ministry, in addition to his own duties with effect from 12th January, 2021, for a period not exceeding 90 days or till posting of a regular incumbent, whichever is earlier.

He is entitled to Special Pay @ 20% of his basic pay subject to maximum of Rs.12,000/- P.M. in terms of existing rules on the subject.

Islamabad, the 19th January, 2021

No. F.2(2)/2021-Admn-I.—With the approval of Secretary, M/o. OPs&HRD, Syed Abbas Ali Shah, Superintendent (BS-16), has been given current charge of the post of Section Officer (Coord) (BS-17) in this Ministry, in addition to his own duties with effect from 18th January, 2021, for a period not exceeding 90 days or till posting of a regular incumbent, whichever is earlier.

He is entitled to Special Pay @ 20% of his basic pay subject to maximum of Rs.12,000/- P.M. in terms of existing rules on the subject.

RAJA SHAHROZE ABBAS,
Section Officer (Admn-I).

MINISTRY OF PARLIAMENTARY AFFAIRS

Islamabad, the 11th January, 2021

No. F.25(7)/2020-PA(Admn).—In pursuance of O/o. the Auditor General of Pakistan's Notification No.60-Dir (A)/2-4/2020, dated 4th December, 2020, Mr. Muhammad Saeed Tiwana, Chief Finance & Accounts Officer (BS-20), M/o. Information Technology & Telecommunication, Islamabad (OPS) is allowed to look after the charge of the post of Chief Finance & Accounts Officer in Ministry of Parliamentary Affairs with effect from 22nd December, 2020.

Islamabad, the 15th January, 2021

No. F.25(1)/96-PA(Admn).—Mr. Asif Robin, Private Secretary, (BS-18), Ministry of Parliamentary Affairs was granted 30 days leave on full pay from 10th December, 2020 to 8th January, 2021 with permission to leave the station.

The officer has resumed his duty on the same post and at the same station, on 11th January, 2021 (9th & 10th January, 2021 being public holidays).

HAFEEZULLAH KHAN,
Section Officer (Admn).

MINISTRY OF PLANNING, DEVELOPMENT AND
SPECIAL INITIATIVES

[PLANNING COMMISSION]

CORRIGENDUM

Islamabad, the 11th January, 2021

No. F.5(12)/CP/HRM-IV/PDSI/2018.—Name of member at Serial number 2 of the Sub-Group of Advisory Committee on "Governance" notified *vide* this Ministry's notification

of even number dated 7th December, 2020 may be read as Dr. Safdar A. Sohail, *Ex-Federal Secretary* instead of Former Director General (NIM).

Islamabad, the 12th January, 2021

No. 10(22)/HRM-I/PD/11.—Mr. Qamar Abbas, Chief (BS-20), Population & Social Planning Section has been allowed to hold additional charge of the post of Chief (BS-20), Health Section, in addition to his own duties with immediate effect for a maximum period of 90 days or till joining of the original incumbent of the post, whichever is earlier.

No. 1(25)/HRM-I/PD/08.—After completion of 30th Mid Career Management Course at National Institute of Management, Karachi Mr. Ghulam Nabi Shaikh, Assistant Chief (BS-18), Industries & Commerce Section, Ministry of Planning, Development & Special Initiatives has resumed charge of his post in the same Section on 12th January, 2021.

Islamabad, the 13th January, 2021

No. 2(3-3)/HRM-I/PDSI/03.—Consequent upon his selection by the Federal Public Service Commission and upon acceptance of terms and conditions of the post offered to him *vide* this Ministry's Memorandum of even number dated 15th December, 2020, the competent authority has been pleased to appoint Mr. Muhammad Tayyab as Assistant Chief (BS-18), Education Section, Ministry of Planning, Development & Special Initiatives, Islamabad with effect from 1st January 2021 on temporary basis.

Mr. Muhammad Tayyab has assumed charge of the post of Assistant Chief (BS-18), Education Section, Ministry of Planning, Development & Reform on 1st January, 2021 after being relieved from General Headquarters, IGT&E's Branch, FGEI(C/G) Directorate *vide* their Notification No.9-11/2016-Emig-I dated 5th November, 2020.

The officer will be on probation for a period of one year with effect from 1st January, 2021, extendable by an order for a further period not exceeding 12 months with effect from the date of the completion of his earlier probation period.

Islamabad, the 15th January, 2021

No. 13(16)/EG/HRM.II/PD/1993.—In pursuance of this Ministry's notification of even number dated 8th January, 2021, Mr. Sohail Hanif, a BS-20 Officer of the Economists Group, has assumed charge of post of Chief (BS-20) in this Ministry on 15th January, 2021.

No. 8(56)/EG/HRM.II/PD/1990.—In pursuance of this Ministry's notification of even number dated 8th January, 2021, Mr. Asif Khan, a BS-20 Officer of the Economists Group, has relinquished charge of post of Chief (BS-20) in this Ministry on 15th January, 2021.

No. 13(60)/EG/HRM.II/PD/2000.—On expiry of ninety (90) days *ex-Pakistan* leave on half pay with effect from 14th October, 2020 to 11th January, 2021, Mr. Nasar Iqbal, Chief (BS-20), Economists Group has resumed charge of his post in this Ministry on 12th January, 2021.

No. 7(28)/EG/HRM.II/PD/2012.—In pursuance to the change made in the Matriculation Certificate of Board of Intermediate and Secondary Education, Multan dated 28th September, 2020 and CNIC bearing No.36303-6642705-9 the recorded name of Mr. Zaila Husnain, Assistant Chief (BS-18), Economists Group, it is hereby notify that henceforth, the name of Mr. Zaila Husnain would be read/written as "Mr. Zille Hasnain" in official record.

Islamabad, the 18th January, 2021

No. 13(42)/HRM-I/PD/93.—Mr. Waheed Zaman, Chief (BS-20), Mass Media Section, Ministry of Planning, Development and Special Initiatives has been allowed thirty (30) days quarantine leave from 19th November, 2020 to 18th December, 2020, subject to title under the Revised Leave Rules, 1980.

On expiry of the leave, the officer has resumed charge of his post in the same Section of this Ministry.

No. 9(13)/EG/HRM.II/PD/2005.—On expiry of medical leave on full pay, Dr. Naila Jabeen, Deputy Chief (BS-19), Economists Group has resumed charge of her post in this Ministry on 13th January, 2021.

No. 8(1-5)/EG/HRM.II/PD/2016.—After completion of 30th Mid Career Management Course at Karachi Mr. Naseerullah Khan, a BS-18 Officer of the Economists Group, has assumed charge of post of Assistant Chief (BS-18) in Ministry of Planning, Development & Special Initiatives on 11th January, 2021.

No. 8(1-5)/EG/HRM.II/PD/2016.—After completion of 30th Mid Career Management Course at Islamabad, Ms. Zara Umer, a BS-18 Officer of the Economists Group has assumed charge of the post of Assistant Chief (BS-18) in Ministry of Planning, Development & Special Initiatives on 11th January, 2021.

No. 9(36)/HRM.I/PD/11.—Mr. Noor Ahmed Khan, Lecturer in Geography (BS-17), Federal Directorate of Education, M/o. Federal Education & Professional Training, presently posted as Assistant Chief (BS-18), Education Section, M/o. Planning, Development & Special Initiatives is repatriated to his parent Department *i.e.* Federal Directorate of Education, Islamabad with immediate effect.

No. 9(36)/HRM.I/PD/11.—In pursuance of this Ministry's notification of even number dated 18th January, 2021, Mr. Noor Ahmed Khan relinquished charge of the post of Assistant Chief (BS-18), Education Section, M/o. Planning, Development & Special Initiatives on 18th January, 2021.

Islamabad, the 20th January, 2021

No. 8(34)/HRM.II/PD&SI/16.—Mr. Muhammad Waqas, Research Officer (BS-17), Physical Planning & Housing Section, Ministry of Planning, Development & Special Initiatives has been allowed to hold current charge of the vacant post of Assistant Chief (BS-18) in the same Section, in addition to his own duties with immediate effect for a period of 90 days or till joining of the original incumbent, whichever is earlier.

SAEED AHMED RAHOOJO,
Section Officer (HRM-I).

Islamabad, the 8th January, 2021

No. F.8(56)/EG/HRM.II/PD/1990.—Following postings/transfers of Chief (BS-20) of the Economists Group, M/o. Planning, Development & Special Initiatives are made with immediate effect and until further orders:-

S. No.	Name of Officers	From	To
1.	Mr. Asif Khan Chief (BS-20)	M/o. PD&SI	Finance Division
2.	Mr. Sohail Hanif Chief (BS-20)	Finance Division	M/o. PD&SI

SEHRISH GHAYAS,
Section Officer (HRM-II).

Islamabad, the 7th January, 2021

No. 9(2)Imp-I/PD&SI/2021.—The competent authority *i.e.* Secretary, Ministry of Planning, Development and Special Initiatives has been pleased to grant extension in contract employment of Ms. Sadia Sarwar, Web Manager/ Developer (PPS-07), of the Project titled "Development Communication" M/o. PD&SI, from 1st January, 2021 to 31st December, 2021.

Islamabad, the 15th January, 2021

No. 44(2)Imp-I/PD&SI/2021.—The Secretary, Ministry of Planning, Development and Special Initiatives has been pleased to accept resignation tendered by Mr. Muhammad Kashif Sharif, Director (Record), of the Project titled "Strengthening of M/o. PD&SI in Monitoring & evaluation of PSDP Projects", M/o. PD&SI with effect from 12th January, 2021.

Consequent upon acceptance of his resignation, Mr. Muhammad Kashif Sharif has been relieved of duties as Director (Record), Strengthening of M/o. PD&SI in

Monitoring & Evaluation of PSDP Project”, M/o. PD&SI with effect from 12th January, 2021. He severs all connections whatsoever with M/o. PD&SI from the same date.

Islamabad, the 18th January, 2020

No. 25(2)Imp-I/PD&SI/2020.—With approval of the Secretary, Ministry of Planning, Development and Special Initiatives, following officers of M/o. PD&SI have been allowed to hold additional charge of vacant post mentioned against each in Development Project titled “Young Development Fellows Programme” for a period of 90 days, with immediate effect:-

Sr. No.	Name and Designation	Post of Project
1.	Javed Sikandar, Chief (Governance), M/o. PD&SI	Project Director
2.	Hazoor Bux Mahar, Deputy Chief (Governance), M/o. PD&SI	Programme Manager
3.	Muhammad Sarwar, Superintendent/ Cashier, M/o. PD&SI	Accounts Officer/ DDO

No. 39(2)Imp-I/PD&SI/2020.—With approval of the Secretary, Ministry of Planning, Development and Special Initiatives, Dr. Muhammad Qaisar Khan, Deputy Chief, Health Section, M/o. PD&SI has been allowed Additional Charge of post of Project Director of the Project titled “Strengthening of Civil Registration & Vital Statistics System” with immediate effect, for a period of 30 days, till further orders.

RASHEED SHAH RASHDI,
Section Officer (Imp-I).

Islamabad, the 7th January, 2021

No. 1-3(3)Imp-II/PD&SI/2020.—The Procurement Committee for Repair and Maintenance under ST for the Project titled “Strengthening of Ministry of Planning Development & Special Initiatives in Monitoring and Evaluation of PSDP Projects” has been constituted with following composition:-

- | | | |
|------|--|----------|
| i. | Syed Zahoor Ali Shah,
Director General (Coordination) | Chairman |
| ii. | Mr. Assad Khurshid,
Chief Mointoring Officer, | Member |
| iii. | Mr. Kazim Abbas Shah,
Director Coordination | Member |
| iv. | Mr. Irshad, Deputy Director (IT) | Member |
| v. | Mr. Fahad Manzoor Bajwa,
Admin Officer | Member |

AYESHA JAVED,
Section Officer Imp-II.

Islamabad, the 13th January, 2021

No. 7(128)HRM-III/PD&SI/19.—Ms. Sarah Mahmood, Section Officer (BS-17), Ministry of Planning, Development & Special Initiatives has been granted 60 days leave not due on full pay with effect from 14th December, 2020 to 11th February, 2021 subject to title under the Revised Leave Rules, 1980.

AMBREEN MAZHAR,
Section Officer.

Islamabad, the 18th January, 2021

No. 9(6)HRM-V/PD&SI/20.—Consequent upon his Selection by the Federal Public Service Commission and upon acceptance of terms and conditions of the post offered to him *vide* this Ministry’s Memorandum No.8(2)HRM-V/PD&SI/19, dated 7th December, 2020, the competent authority has been pleased to appoint Malik Muhammad Naeem as Assistant Private Secretary (BS-16), Ministry of Planning, Development & Special Initiatives, Islamabad with effect from 15th January, 2021 on temporary basis.

Malik Muhammad Naeem has assumed charge of the post of Assistant Private Secretary (BS-16), Ministry of Planning, Development & Special Initiatives on 15th January, 2021.

The official will be on probation for a period of one year with effect from 15th January, 2021, extendable for a further period not exceeding 12 months with effect from the date of the completion of his earlier probation period.

SHAHID AHMED,
Section Officer.

MINISTRY OF RAILWAYS

[RAILWAY BOARD]

Islamabad, the 11th January, 2021

No. 5/271-3/2006-A-I.—In compliance with the orders of the Hon’ble Islamabad High Court, Islamabad dated 23rd November, 2020 passed in Writ Petition No.3143/2020, the Secretary/ Chairman Railways (Authority) is pleased to release Mr. Haseen Ullah, a BS-17 Officer of Railways (Commercial & Transportation) Group from suspension with effect from 23rd November, 2020. His remaining period with effect from 11th October, 2020 to 22nd November, 2020 will be treated as period on suspension.

Islamabad, the 12th January, 2021

No. F.5/340-3/2013-A-I.—In pursuance of Establishment Division’s Notification No.1/269/2020-E-4 dated 21st December, 2020, Mr. Sohaib Rasheed, a BS-17 Officer of

Railways (Commercial & Transportation) Group, presently working as Assistant Transportation Officer-I, Karachi is hereby relieved from Pakistan Railways with immediate effect enabling to join "Trade Development Authority Pakistan (TDAP) under Ministry of Commerce as Assistant Director (BS-17)" on deputation basis for a period of three years on standard terms and conditions.

This issues with the approval of the Secretary/ Chairman Railways.

Islamabad, the 19th January, 2021

No. 6/3-3/2021-A-I.—The following transfers/ postings are made with immediate effect and until further orders:

- (i) Mr. Ghulam Dastgir Khan Baloch, (Railways (C&T) Group/BS-20), presently working as Special Assistant to Federal Minister for Railways, Islamabad is posted as Chief Executive Officer PRFTC, Pakistan Railways, Hqs. Office, Lahore relieving additional charge of Syed Mazhar Ali Shah, AGM/Traffic. He will also hold additional charge of the Special Assistant to Federal Minister for Railways, Islamabad.
- (ii) Mr. Kashif Rasheed Yousfani, (Railways (C&T) Group/ BS-19), presently working as Director/ Establishment, Ministry of Railways, Islamabad is transferred and posted as Chief Marketing Manager (BS-20/ OPS), Pakistan Railways, Hqs. Office, Lahore *vice* Mr. Shoaib Adil.
- (iii) Mr. Mehmood Rehman Lakho, (Railways (C&T) Group/BS-19), presently working Dy. COPS /Goods, Pakistan Railways, Hqs. Lahore is transferred and posted as Joint Director/ Traffic (BS-19), Pakistan Railways Academy, Walton, Lahore *vice* Mr. Hamdan Nazir.
- (iv) Mr. Hamdan Nazir, (Railways (C&T) Group/ BS-19), presently working as Joint Director / Traffic, Pakistan Railways Academy, Walton, Lahore is transferred and posted as Dy. CCPS/Goods (BS-19), Pakistan Railways, Hqs. Office, Lahore *vice* Mr. Mehmood Rehman Lakho.

2. This issues with the approval of Secretary/ Chairman Railways.

Islamabad, the 20th January, 2021

No. 6/3-3/2021-A-I.—The following transfers/ postings are made with immediate effect and until further orders:

- i) Mr. Shah Rukh Afshar, (Civil/BS-20), presently working as Additional General Manager (Infrastructure/ BS-21/ OPS),

Pakistan Railways, HQs Office, Lahore is transferred and directed to immediately report to Ministry of Railways, Islamabad.

- ii) Syed Asif Mateen Zaidi, (Civil/BS-20), presently working as Chief Engineer (Open Line), Pakistan Railways, HQs Office, Lahore is transferred and posted as Additional General Manager (Infrastructure/ BS-21/ OPS), Pakistan Railways, HQs Office, Lahore *vide* Mr. Shah Rukh Afshar, transferred.
- iii) Mr. Arshad Salam Khattak, (Civil/ BS-20), presently working as Divisional Superintendent, Pakistan Railways, Karachi is transferred and posted as Chief Engineer (Open Line/ BS-20), Pakistan Railways, HQs Office, Lahore *vice* Syed Asif Mateen Zaidi, transferred.
- iv) Mr. Azam Ghafoor, (Stores & Purchase/ BS-20), presently working as Chief Controller of Stores, Pakistan Railways, HQs, Office, Lahore is transferred and posted as Chief Controller of Purchase (BS-20), Pakistan Railways, HQs Office, Lahore *vice* Mr. Sohail Iqbal Siddiqui.
- v) Mr. Sohail Iqbal Siddiqui, (Stores & Purchase/ BS-19), presently working as Chief Controller of Purchase, (BS-20/ OPS) is transferred and directed to report to CEO /Sr. GM, Pakistan Railways, HQs Office, Lahore for further posting.
- vi) Mr. Rashid Shahzad, (Stores & Purchase/ BS-19), presently awaiting posting is posted as Chief Controller of Stores (BS-20/ OPS), Pakistan Railways, HQs Office, Lahore *vice* Mr. Azam Ghafoor, transferred.
- vii) Mr. Muhammad Hanif Gul (Railways (C&T) Group/ BS-20), presently working as Divisional Superintendent, Pakistan Railways, Gawadar is transferred and posted as Divisional Superintendent (BS-20), Pakistan Railways, Karachi *vice* Mr. Arshad Salam Khattak, transferred.
- viii) Syed Imtiaz Hussain Farooq, (Railways (C&T) Group/ BS-18), presently working as STM (Freight), Pakistan Railways, HQs Office, Lahore is transferred and posted as Director (Operations/ BS-19/OPS), Ministry of Railways, Islamabad against a vacant post.
- ix) In partial modification of this Ministry's notification dated 19th January, 2021, Mr. Mehmood Rehman Lakho, (Railways (C&T) Group/ BS-19), presently working as

Dy. COPS (Goods), Pakistan Railways, HQs Office, Lahore is transferred and posted as Director (Establishment/ BS-19), Ministry of Railways, Islamabad *vice* Mr. Kashif Rasheed Yousfani, transferred.

2. This issues with the approval of Secretary/ Chairman Railways.

Islamabad, the 13th January, 2021

No. Admn-IV/1864-P.—In pursuance of Ministry of Information and Broadcasting, Islamabad Notification No.494/IG dated 22nd December, 2020, Mr. Ali Nawaz Malik a BS-19 Officer of the Information Group, presently posted as Director /Media (BS-19), Ministry of Railways has relinquished the charge of the post of Director /Media, Ministry of Railways, Islamabad with effect from 23rd December, 2020.

Islamabad, the 14th January, 2021

No. Admn-IV/19-TR/3.—Mr. Junaid Saleem Malik, a BS-18 Officer of (Store & Purchase) Department of Pakistan Railways on return from MCMC Course is posted as Deputy Director/ Admn-II *vice* vacancy with effect from 11th January, 2021.

This issues with the approval of Secretary/ Chairman Railways.

FAHEEM AHMED MALIK,
Assistant Director Admn-IV.

Islamabad, the 11th January, 2021

No. FW/EF/2016/NO-1/2.—Consequent upon promotion in BS-18 with effect from 1st January, 2020 in terms of Ministry of Railways, Islamabad's Notification No.FW/EF/2020/PM-1/3 dated 14th December, 2020 and FA&CAO/PR Pakistan Railway Lahore's Office S.O.O No.01/Admn-I/2021 dated 1st January, 2021, Mr. Mushk-I-Alam, Accounts Officer/Payment (BS-17) (OPS), Ministry of Railways, (Railways Board), Islamabad has assumed the charge of the post of Accounts Officer/ Payment (BS-18), Ministry of Railways, (Railway Board), Islamabad with effect from 1st January, 2021.

HUMERA REHMAN,
(Assistant Director/ Confdl.).

MINISTRY OF RELIGIOUS AFFAIRS AND
INTERFAITH HARMONY

Islamabad, the 14th January, 2021

No. F.10(1)/DD(Q)/2016.—In pursuance of the decision of the Central Ruet-e-Hilal Committee, in its meeting held today at Islamabad, the Federal Government in the Ministry

of Religious Affairs and Interfaith Harmony hereby announce that the moon of Jamad-ul-Sani 1442 AH has sighted, therefore the 1st Jamad ul Sani 1442 AH shall commence from Friday, the 15th January, 2021.

HAFIZ ABDUL QUDOOS,
Director (R&R).

[DIRECTORATE OF HAJJ]

Islamabad, the 13th January, 2021

No. 4(58)/1996-A&E.—Mrs. Qamar Shafiq, Staff Nurse (BPS-16), Hajj Dispensary, Directorate of Hajj, Islamabad is hereby granted 33 days L.F.P. with effect from 18th January, 2021 to 19th February, 2021.

On expiry of the said leave, she shall likely to resume her duty on the same post.

HASSEB AHMED SIDDIQUI,
Director (Hajj).

MINISTRY OF SCIENCE & TECHNOLOGY

Islamabad, the 11th January, 2021

No. F.2(55)/2013-PSQCA.—Having been found guilty of misconduct in terms of Rule 2(4) read with Rule 3(b) of Government Servants (Efficiency & Disciplinary) Rules 1973, and on the recommendation of Authorized Officer, the competent authority *i.e.* Secretary, Ministry of Science and Technology, MoST has imposed the major penalty of "Removal from Service" upon Mr. Nazeer Ahmed Lajwani, Assistant Director, BPS-17, SDC, PSQCA Karachi, under rule 4(1)(b)(iii) of Government Servants (Efficiency & Disciplinary) Rule 1973 with immediate effect.

He can appeal against the order within thirty days as admissible under Civil Servants (Appeal) Rules, 1977.

ASHAR MAHMOOD,
Section Officer (Org-III).

NATIONAL ASSEMBLY SECRETARIAT

Islamabad, the 1st March, 2021

No. T(228)/Estt.I(57).—Mr. Inam Ahmed, Deputy Director (Translation) (BS-19) in the National Assembly Secretariat is granted 15 days Rest and Recreation (R&R) leave in lieu of 10 days LFP with effect from 1st March, 2021 with permission to prefix Saturday & Sunday, the 27th & 28th February, 2021 to his leave.

On expiry of the above leave, he is expected to resume duty of the same post with effect from 16th March, 2021.

Islamabad, the 5th March, 2021

No. G(527)/Estt-I(58).—Ms. Bisma Rehman Zafar, Assistant Director (Research) (BS-17) in the National Assembly Secretariat is granted 15 days Rest and Recreation (R&R) leave in lieu of 10 days LFP with effect from 3rd March, 2021.

On expiry of the above leave, she is expected to resume duty of the same post with effect from 18th March, 2021.

Islamabad, the 8th March, 2021

No. G(534)/Estt-I(59).—On expiry of the leave granted *vide* this Secretariat's Notification No.G(534)/Estt.I(52) dated 11th February, 2021, Mr. Salman Ahmed, Translation Officer (BS-16) in the National Assembly Secretariat has resumed the charge of the same post with effect from 8th March, 2021.

Islamabad, the 10th March, 2021

No. 19(6)/2019-Estt.I(60).—The officers in column (2) were promoted in this Secretariat with effect from the date(s) in column (4) on the recommendations of Departmental Promotion Committees and they were placed under probation for a period of one year. The competent authority has been pleased to terminate their probation period under section 8(4) of the National Assembly Secretariat Employees Act 2018 on successful completion of one year from the date of their promotion:-

S. No.	Name	Designation	Date of Promotion
(1)	(2)	(3)	(4)
1.	Syed Haseen Raza Zaidi	Deputy Secretary (BS-19)	26th March, 2019
2.	Mr. Muhammad Farooq Mushtaq	Deputy Secretary (BS-19)	23rd December, 2019
3.	Mr. Muhammad Iqbal	Deputy Secretary (BS-19)	23rd December, 2019
4.	Mr. Abdul Majeed	Director (Reporting-Eng) (BS-19)	3rd December, 2019
5.	Syed Jamshed Haider Naqvi	Deputy Director (Translation) (BS-18)	11th December, 2019
6.	Mr. Nisar Ahmed	Section Officer (BS-18)	23rd December, 2019
7.	Mr. Naveed Anjum	Assistant Director (IT) (BS-17)	23rd December, 2019

S. No.	Name	Designation	Date of Promotion
(1)	(2)	(3)	(4)
8.	Mr. Shahzad Razzaq	Section Officer (BS-17)	23rd December, 2019
9.	Ms. Azra Begum	Section Officer (BS-17)	23rd December, 2019
10.	Mr. Ghulam Muhammad Mustafa	Assistant Director (Translation) (BS-17)	26th March, 2019
11.	Ms. Tahira Sadaf	Assistant Director (Translation) (BS-17)	23rd December, 2019
12.	Mr. Niaz Muhammad	Superintendent (BS-16)	23rd December, 2019

No. G(551)/Estt.I(61).—Mr. Muhammad Adeel Tahir, Deputy Director (IT) (BS-18) in the National Assembly Secretariat is granted 120 days leave on full pay on medical grounds with effect from 8th February, 2021 with permission to prefix Saturday & Sunday, the 6th & 7th February, 2021 and suffix Saturday & Sunday, the 3rd & 4th June, 2021.

On expiry of the above leave, he is expected to resume charge of the same post at Islamabad on 6th June, 2021.

SHEHRYAR KHAN,
Section Officer.

SENATE SECRETARIAT

Islamabad, the 2nd March, 2021

No. F.21(1)/2019-HRM(20).—The competent authority has been pleased to appoint Mr. Farhat Hayat working as Assistant Director (IT) (BPS-17) in Senate, against the post of Section Officer (BPS-17), through proper channel on regular basis, in the Senate Secretariat with effect from 24th February, 2021.

He is placed on probation for a period of two years extendable by a further period not exceeding one year provided that if no order has been made by the day following the termination of either of the aforementioned probationary period, the appointment shall be deemed to be held until further orders.

The other terms and conditions of his appointment will be the same as conveyed to him *vide* this Secretariat

Memorandum No.F.21(1)/2019-HRM, dated the 23rd February, 2021.

This issues with the approval of the Chairman Senate.

Islamabad, the 10th March, 2021

No. F.21(1)/2019-HRM(28).—The competent authority has been pleased to appoint Mr. Tofique Ahmed Memon, presently working as Assistant Director (Reporting) (BPS-17) on adhoc basis in Senate Secretariat, against the post of Assistant Director (Reporting-Bilingual) (BPS-17), through proper channel on regular basis, in the Senate Secretariat with effect from 24th February, 2021.

He is placed on probation for a period of two years extendable by a further period not exceeding one year provided that if no order has been made by the day following the termination of either of the aforementioned probationary period, the appointment shall be deemed to be held until further orders.

The other terms and conditions of his appointment will be the same as conveyed to him *vide* this Secretariat Memorandum No.F.21(1)/2019-HRM, dated the 23rd February, 2021.

This issues with the approval of the Chairman Senate.

ZAHOOR AHMED,
Section Officer (HRM-I).

Islamabad, the 1st March, 2021

No. M(1004)/2021-HRM(21).—In pursuance to the decision of Senate Finance Committee in its 47th meeting held on 8th January, 2021 and in continuation of Senate Secretariat's Notification No.F.3(2)/2020-HRM(20), the competent authority has been pleased to regularize the contract services of Mr. Shah Jamal Akbar, Assistant Protocol Officer (BPS-16) in the Senate Secretariat, Islamabad, with immediate effect.

He shall be on probation for a period of two years as provided in Rule 18(1) of Senate Secretariat (Service) Rules, 2017.

This issues with the approval of the Chairman Senate.

Islamabad, the 2nd March, 2021

No. F.21(1)/2019-HRM(20).—The competent authority has been pleased to appoint Mr. Farhat Hayat, Section Officer (BPS-17) against the post of Section Officer (BPS-17), on regular basis, in the Senate Secretariat with effect from 24th February, 2021.

He is placed on probation for a period of two years extendable by a further period not exceeding one year provided that if no order has been made by the day

following the termination of either of the aforementioned probationary period, the appointment shall be deemed to be held until further orders.

The other terms and conditions of his appointment will be the same as conveyed to him *vide* this Secretariat Memorandum No.F.21(1)/2019-HRM, dated the 23rd February, 2021.

This issues with the approval of the Chairman Senate.

Islamabad, the 3rd March, 2021

No. M(318)/94-HRM(23).—Upon completion of his Ph.D degree, name of Mr. Hassan Gul Eshrat, Director Staff (BPS-19), Senate Secretariat, Islamabad, may be written as Dr. Hassan Gul Eshrat, in official record.

Therefore, the concerned quarters are requested to take necessary action in this regard.

This issues with the approval of the competent authority.

No. G(223)/2014-HRM(22).—Mr. Javaid Rasool, Assistant Director (Research) (BPS-17), Senate Secretariat, Islamabad, is granted subject to title, 15 days rest & recreation leave in lieu of 10 days leave on full pay with effect from 1st March, 2021 with permission to prefix Saturday and Sunday falling on 27th & 28th February, 2021, respectively to the leave.

After expiry of the leave he is likely to resume duty of the same post at Islamabad.

Islamabad, the 4th March, 2021

No. M(310)/1994-HRM(25).—Mr. Muhammad Iqbal, Director Staff (BPS-19), Senate Secretariat Islamabad, is granted subject to title, 15 days rest & recreation leave in lieu of 10 days leave on full pay with effect from 1st March, 2021 with permission to prefix Saturday and Sunday falling on 27th & 28th February, 2021, respectively to the leave.

After expiry of the leave, he is likely to resume duty of the same post at Islamabad.

No. F.3(3)/2020-HRM-I(24).—The competent authority has been pleased to appoint Mr. Farid-ud-Din, Audit Officer (BPS-18), Auditor General of Pakistan, Islamabad, as Finance & Accounts Officer (BPS-18) on deputation basis, on standard terms and conditions, in the Senate Secretariat, Islamabad, with immediate effect.

He will be entitled to draw deputation allowance @ 20% of his basic pay, subject to a maximum of Rs.12,000/- per month.

This issues with the approval of Chairman Senate.

No. PA(50)/2018-HRM-II(18).—The competent authority has been pleased to terminate the probation period of Mr. Ayub Khan, Assistant Private Secretary (BS-16), Senate Secretariat, Islamabad, with effect from 22nd March, 2021.

No. F.3(2)/2020-HRM(19).—The competent authority has been pleased to appoint of Ms. Marriam Nabeel Singha D/o. John Kenneth Williams, against the post of Assistant Media Officer (BPS-16) on contract basis, without advertisement under Rule-17 of Senate Secretariat (Service) Rules, 2017 for a period of 04 weeks *i.e.* 23rd February, 2021.

The other terms and conditions of his appointment will be the same as conveyed to him *vide* the Senate Secretariat's Letter No.F.3(2)/2020-HRM, dated the 15th February, 2021.

This issues with the approval of Chairman Senate.

Islamabad, the 5th March, 2021

No. F.21(1)/2019-HRM(26).—The competent authority has been pleased to appoint Mr. Saqib Anwar, presently working as Assistant Director (Research) (BPS-17) (on ad-hoc basis), as Assistant Director (Research) on regular basis, against the advertised vacancy, in BPS-17 *viz* Rs.30,370-2,300-76,370, *plus* usual allowances, as admissible to the Federal Government employees, from time to time, in the Senate Secretariat with effect from 9th February, 2021.

He is placed on probation for a period of two years extendable by a further period not exceeding one year provided that if no order has been made by the day following the termination of either of the aforementioned probationary period, the appointment shall be deemed to be held until further orders.

The other terms and conditions of his appointment will be the same as conveyed to him *vide* this Secretariat Memorandum No.F.21(1)/2019-HRM, dated 4th February, 2021.

This issues with the approval of Chairman Senate.

No. M(739)/2015-HRM(27).—In continuation of this Secretariat's Notification No.M(739)/2015(139), dated 28th August, 2020. The competent authority has been pleased to extend an *ad-hoc* period of Mr. Saqib Anwar, Assistant Director Research (BPS-17) (*ad-hoc* basis) for a period from 17th December, 2020 to 8th February, 2021, in the Senat Secretariat, Islamabad.

This issues with the approval of Chairman Senate.

Islamabad, the 9th March, 2021

No. M(798)/2016-HRM(22).—The competent authority has approved to extend the probation period of the following Assistant Private Secretaries (BS-16), Senate

Secretariat, Islamabad, for a period of six months with effect from 13th March, 2021, under Rule 18(1) of the Senate Secretariat (Service) Rules, 2017:-

- i. Mr. Muhammad Farhan Yousaf
- ii. Mr. Asim Khan
- iii. Mirza Khan
- iv. Mr. Muhammad Naeem
- v. Rana Usman Mazhar

2. This issues with the approval of competent authority.

SADIA AMIR,
Section Officer (HRM-II).

SUPREME COURT OF PAKISTAN

Islamabad, the 3rd March, 2021

No. F.24/836/2015-SCA.—Mr. A. Shabbir Khan Khattak, Deputy Registrar (BS-20) of this Court is granted thirteen (13) days' LFP with effect from 15th February, 2021 to 27th February, 2021 (both days inclusive), on medical grounds, subject to verification of title of his leave account by the AGPR, Islamabad.

Islamabad, the 8th March, 2021

No. F.24/927/2021-SCA.—Mr. Ghulam Mujtaba Son of Muhammad Rafique is appointed as Assistant Private Secretary (BS-16) to Mr. Justice Iftikhar Muhammad Chaudhry, Hon'ble Former Chief Justice of Pakistan in this Court, with effect from 4th March, 2021, on the following terms and conditions:-

1.	Post	Assistant Private Secretary (BS-16)
2.	Place of Posting	With Mr. Justice Iftikhar Muhammad Chaudhry, Hon'ble Former Chief Justice of Pakistan or anywhere as the competent authority may decide.
3.	Period of Contract	Two years w.e.f. 04.03.2021 and will be valid only during life time of Mr. Justice Iftikhar Muhammad Chaudhry, Former HCJ
4.	Pay & Allowances	He will draw his salary in basic pay scale No.16 <i>viz</i> : Rs.18910-1520-64510 <i>plus</i> other usual allowances as may be admissible to his class of officers under the Supreme Court of Pakistan, from time to time.
5.	Travelling Allowance	As admissible to officers of Supreme Court of Pakistan/ Civil servants of the corresponding pay scale under the rules.

6.	Seniority	This contract appointment does not confer any right for being placed in the gradation/ seniority list of the cadre/group to which the subject post belongs.
7.	Leave	As admissible under the Federal Government Revised Leave Rules, 1980. However, provisions contained in Rules 5(c), 8, 11, 14, 16, 17, 18, 18-A, 19, 27, 33, 34, 35, 36 & 39 of Rules <i>ibid</i> shall not apply.
8.	Medical Facilities	As admissible to officers of the Supreme Court of Pakistan under the Rules provided that he is not availing medical facility under Government already.
9.	Pension	Service rendered under this contract shall not qualify for a pension or gratuity.
10.	General Provident Fund	No contribution towards G.P Fund shall be required.
11.	Conduct and Discipline	Supreme Court Establishment Service Rules, 2015 and instructions issued by the Supreme Court of Pakistan/ Federal Government or a prescribed authority shall apply.
12.	Appeal	Supreme Court Establishment Service Rules, 2015, shall apply.
13.	Termination of contract	The appointment during the period of contract shall be liable to termination on 30 days notice on either side or payment of basic pay in lieu thereof, without assigning any reason.
14.	Whole time employment posting and transfer	Whole time of the contract appointee would be at the disposal of the Hon'ble Former Chief Justice of Pakistan. He may be employed in any manner required by his lordship without claim for additional remuneration. He shall at all times obey the rules prescribed for the time being for the regulation of the service or cadre to which the post in which he has been employed belongs.
15.	Other matters	In respect of other matters not specified in this contract, the rules/ regulations as applicable to Supreme Court Employees /Civil Servants shall apply.
16.	Accommodation	Same facility of Government owned or hired residence as is admissible to persons of corresponding grade.

Islamabad, the 9th March, 2021

No. F.24/763/2008-SCA.—Syeda Saima Shabbir, Senior Research Officer (BS-20) of this Court is granted seven (07) days' LFP with effect from 5th March, 2021 to 11th March, 2021 (both days inclusive), on account of private affairs, subject to verification of title of her leave account by the AGPR, Islamabad.

No. F.24/569/99-SCA.—Mr. Sohail Ahmed, Assistant Registrar (BS-19) of this Court is granted ten (10) days' LFP with effect from 21st April, 2021 to 30th April, 2021 (both days inclusive), on account of private affairs, subject to verification of title of his leave account by the AGPR, Islamabad.

PERVAIZ IQBAL,
Assistant Registrar (Admn).

FEDERAL SHARIAT COURT

Islamabad, the 27th February, 2021

No. F.1(645)/2017-Admn-FSC.—Mrs. Amna Hejab, Judicial Assistant (B-17) of this Court is hereby granted 40 days leave with full pay with effect from 18th January, 2021 to 26th February, 2021, subject to verification by the Audit.

On return from leave she has joined the same post at the same station on 27th February, 2021.

No. F.1(156)/82-Admn-FSC.—Mr. Javed Iqbal, Judicial Assistant (B-17) of this Court is hereby granted 12 days leave with full pay with effect from 15th February, 2021 to 26th February, 2021, subject to verification by the Audit.

On return from leave he has joined the same post at the same station on 27th February, 2021.

MUHAMMAD ILYAS,
Assistant Registrar (Admn).

Islamabad, the 22nd February, 2021

No. F.1(227)/85-Admn-FSC.—In supersession of this Court's notification of even number, dated 16th September, 2020, Mr. Muhammad Aslam, Assistant Registrar (B-19) has been retired from Government Service with effect from 4th February, 2021 (afternoon) on attaining the age of superannuation.

ABDUL HAMEED,
Superintendent (Admn).

The Gazette of Pakistan

PUBLISHED BY AUTHORITY

KARACHI, WEDNESDAY, APRIL 28, 2021

PART II

Notifications issued by Ministry of Defence and Ministry of Defence Production

Karachi, the 28th April, 2021

MINISTRY OF DEFENCE

(Defence Division)

No. 314/2021 :

The following officers have been appointed as Colonel of the Regiment / Battalion as mentioned against each, with effect from 26th February, 2021 :

S. No.	No. Rank & Name	Regiment / Battalion
1.	PA-33335 Col. Zafar Aqil	42 Frontier Force Regiment
2.	PA-35902 Col. Mazhar Hussain	9 Light Commando Battalion (FF)
3.	PA-36007 Col. Khalid Hussain Nazir	185 Mountain Regiment Artillery
4.	PA-36158 Col. Shahid Sakhawat	22 Engineer Battalion
5.	PA-32359 Col. Farrukh Mirza, SI(M) (Retd.)	151 Light Air Defence (SP) Regiment

[No. 2/2/D-2(A-II)/2021].

No. 315/2021 :

The names of following Officers have been changed as under :-

For	Read
PA-26455 Lt. Gen. Muhammad Waseem Ashraf	PA-26455 Lt. Gen. Muhammad Waseem Ashraf Raja
PA-34284 Brig. Kamran Ahmad	PA-34284 Brig. Kamran Ahmed

For	Read
PA-36564 Col. Arif Rabani	PA-36564 Col. Arif Rabbani
PA-33263 Col. Naweed Anwar	PA-33263 Col. Naveed Anwar
PA-34420 Col. Amir Naveed	PA-34420 Col. Aamir Naveed Hussain
PA-42054 Lt. Col. M. Waqas Rasheed	PA-42054 Lt. Col. Muhammad Waqas Rasheed
PA-37890 Lt. Col. Muddassor Javed	PA-37890 Lt. Col. Muddassir Javed
MO-10379 Lt. Col. Muhammad Abdul Quddoos Kiani	MO-10379 Lt. Col. Muhammad Abdul Quddoos Kayani
PA-34442 Lt. Col. Tahir Aziz	PA-34442 Lt. Col. Tahir Aziz Chaudhry
JSS-03369 Maj. Nazia Nadeem Rizvi	JSS-03369 Maj. Nazia Safdar
PSS-52196 Maj. Benash Pervez	PSS-52196 Maj. Beenish Pervez

[No. 4/2/D-2(A-II)/2021].

No. 316/2021 :

In pursuance of Establishment Division's Notification Bearing No. F. No. 39/1107/2021-E-I, dated 1st March, 2021, Mr. Waqar Hussain Abbasi has assumed the charge of the post of Joint Secretary (BS-20/SG) in Ministry of Defence, Defence Division on 9th March, 2021.

[No. 5/4/2018/D-26(Admin-I)].

No. 317/2021 :

PA-24468 Maj. Gen. Manzoor Ahmed, HI(M), CMI has been dismissed from service, with effect from 9th March, 2021 and struck off strength from the same date.

[No. 4/6/D-2(A-II)/2020].

No. 318/2021 :

The following Honorary Lieutenants and Subedar Majors/ Subedars have been granted Honorary Commission to the rank of Honorary Captain / Lieutenant, with effect from 23rd March, 2021 :-

HONORARY CAPTAIN				
S. No.	Army No.	Rank	Name	Arm/Service
1.	PJO-1067243	H/ Lt. Clk.	Zahid Ali, TK-I	AC
2.	PJO-2592951	Hon. Lt.	Shafiq Abbas Khan, TK-I	Baloch

S. No.	Army No.	Rank	Name	Arm/Service
3.	PJO-2588492	Hon. Lt.	Ghulam Murtaza, TK-I	Baloch
4.	PJO-2591898	Hon. Lt.	Muhammad Saddique, TK-I	Baloch
5.	PJO-3329877	Hon. Lt.	Fazli Qadir, TK-I	FF
6.	PJO-2822574	Hon. Lt.	Muhammad Akram, TK-I	AK
7.	PJO-3444720	Hon. Lt.	Rounaqe Ali, TK-I	Sindh
8.	PJO-3058443	H/ Lt. Clk.	Sajid Mehmood, TK-I	Arty.
9.	PJO-3075313	Hon. Lt.	Shoukat Hussain, TK-I	Arty.
10.	PJO-3062171	Hon. Lt.	Muhammad Iqbal, TK-I	Arty.
11.	PJO-3069748	Hon. Lt.	Muhammad Ayub, TK-I	Arty.
12.	PJO-3055932	Hon. Lt.	Naseem Shahid Mirza, TK-I	Arty.
13.	PJO-3066819	Hon. Lt.	Riaz Ullah, TK-I	AAD
14.	PJO-1704952	Hon. Lt.	Muhammad Aslam, TK-I	Engrs.
15.	PJO-3636356	H/ Lt. Clk.	Zulfiqar Ali, TK-I	Sigs.
16.	PJO-3638904	Hon. Lt.	Muhammad Tufail, TK-I	Sigs.
17.	PJO-3253722	Hon. Lt.	Muhammad Saeed, TK-I	ASC
18.	PJO-7347277	Hon. Lt.	Mehtab Khan, TK-I	AMC
19.	PJO-6878678	H/ Lt. SMT.	Manzoor Ali, TK-I	Ord.
20.	PJO-6877884	Hon. Lt.	Azhar Saleem TK-I	Ord.
21.	PJO-7112481	Hon. Lt.	Sher Muhammad, TK-I	EME
22.	PJO-7109832	Hon. Lt.	Shamas Din, TK-I	EME

S. No.	Army No.	Rank	Name	Arm/Service
23.	PJO-7108300	Hon. Lt.	Javaid Iqbal, TK-I	EME
24.	PJO-165944	Hon. Lt.	Hafiz Muhammad Mumtaz, TK-I	AEC
25.	MJ-469141	Hon. Lt.	Abdul Khaliq, TK-I	MJD
HONORARY LIEUTENANT				
1.	PJO-1068065	RM Clk.	Bashir Ahmad, TK-I	AC
2.	PJO-1072566	RM	Muhammad Ejaz, TK-I	AC
3.	PJO-1070291	RM	Muhammad Rafiq Kiani, TK-I	AC
4.	PJO-2370973	SM Clk.	Khalid Hussain, TK-I	Punjab
5.	PJO-2373511	SM Clk.	Muhammad Arif	Punjab
6.	PJO-2387843	Sub.	Muhammad Abrar, TK-I	Punjab
7.	PJO-2374088	SM	Muhammad Majeed, TK-I	Punjab
8.	PJO-2378416	SM	Murad Ali Khan, TK-I	Punjab
9.	PJO-2376271	SM	Irfan Mehmood Anjum, TK-I	Punjab
10.	PJO-2376681	SM	Abdul Rehman, TK-I	Punjab
11.	PJO-2590053	SM	Mehdi Khan, TK-I	Baloch
12.	PJO-2588425	SM	Liaquat Ali, TK-I	Baloch
13.	PJO-2591973	SM	Muhammad Salim	Baloch
14.	PJO-2595601	SM	Muhammad Ismail, TK-I	Baloch
15.	PJO-2592166	SM	Shoukat Nawaz, TK-I	Baloch
16.	PJO-2591804	SM	Muhammad Jamil, TK-I	Baloch
17.	PJO-2590085	SM	Fateh Muhammad, TK-I	Baloch

S. No.	Army No.	Rank	Name	Arm/Service
18.	PJO-2581316	SM	Asim Raza, TK-I	Baloch
19.	PJO-2593563	SM	Munir Ahmed Saqib, TK-I	Baloch
20.	PJO-3060208	SM Steno	Ahmed Din, TK-I	FF
21.	PJO-3331339	SM	Wazir Badshah, TK-I	FF
22.	PJO-3326222	SM	Liaqat Hussain, TK-I	FF
23.	PJO-3330262	SM	Muhammad Akhtar, TK-I	FF
24.	PJO-3324500	SM	Khizar Hayat, TK-I	FF
25.	PJO-2822853	SM	Muhammad Ashraf , TK-I	AK
26.	PJO-2825257	SM	Abdul Hamid Khan, TK-I	AK
27.	PJO-2821717	SM	Irshad Anjum, TK-I	AK
28.	PJO-2826218	SM	Muhammad Rashid, TK-I	AK
29.	PJO-2826772	SM	Muhammad Asif Yasar, TK-I	AK
30.	PJO-2376516	SM	Muhammad Aslam, TK-I	Sindh
31.	PJO-3060516	SM Clk.	Akmal Hussain Shah, TK-I	Arty.
32.	PJO-3060191	SM Clk.	Tariq Mehmood, TK-I	Arty.
33.	PJO-3070240	SM	Muhammad Amin, TK-I	Arty.
34.	PJO-3061363	SM	Saif Ur Rehman, TK-I	Arty.
35.	PJO-3065105	SM	Muhammad Asghar, TK-I	Arty.
36.	PJO-3063546	SM	Masood Hussain, TK-I	Arty.
37.	PJO-3083310	SM	Muhammad Jamshad Khan, TK-II	Arty.

S. No.	Army No.	Rank	Name	Arm/Service
38.	PJO-3067736	SM	Shafqat Ali Awan, TK-I	Arty.
39.	PJO-3067350	SM	Zahid Hussain, TK-II	Arty.
40.	PJO-3067107	SM	Muhammad Amir, TK-I	Arty.
41.	PJO-3054535	SM	Nazar Muhammad, TK-I	Arty.
42.	PJO-3070323	Sub.	Tariq Mehmood, TK-I	Arty.
43.	PJO-3074297	SM	Muhammad Younas, TK-II	Arty.
44.	PJO-3070649	SM	Muhammad Akram, TK-I	Arty.
45.	PJO-3073689	SM	Qumar Ghulam, TK-II	Arty.
46.	PJO-3085561	SM	Ghulam Mustafa, TK-II	Arty.
47.	PJO-3069854	SM	Muhammad Bakhtiar, TK-II	Arty.
48.	PJO-3058422	SM Clk.	Muhammad Javed Akhtar, TK-I	AAD
49.	PJO-3070178	SM	Muhammad Anwar Khan, TK-I	AAD
50.	PJO-3064581	SM	Mushtaq Ahmed, TK-I	AAD
51.	PJO-3063156	SM	Ishfaq Ahmed, TK-I	AAD
52.	PJO-3060233	SM	Manzoor Ahmed, TK-I	AAD
53.	PJO-3828391	SM	Rafaqat Zaman, TK-I	AAD
54.	PJO-3062846	SM	Mehar Khan, TK-I	AAD
55.	PJO-1705210	SM Clk.	Irfan Ahmed, TK-I	Engrs.
56.	PJO-1709136	SM Clk.	Muhammad Aslam	Engrs.
57.	PJO-1708876	SM	Ijaz Mehmood, TK-I	Engrs.

S. No.	Army No.	Rank	Name	Arm/Service
58.	PJO-1705043	SM	Saeed Ahmed, TK-I	Engrs.
59.	PJO-1707336	SM	Muhammad Nawaz Shad, TK-I	Engrs.
60.	PJO-1706311	SM	Abdul Baqi, TK-I	Engrs.
61.	PJO-3638099	SM Clk.	Gulzar Ahmad, TK-I	Sigs.
62.	PJO-3643909	SM	Muhammad Khurshid Khan, TK-I	Sigs.
63.	PJO-3635658	SM	Shabbir Ahmad, TK-I	Sigs.
64.	PJO-3640930	SM	Fazal-UI-Haq, TK-II	Sigs.
65.	PJO-3640155	SM	Qismat Zada, TK-II	Sigs.
66.	PJO-3643874	SM	Muhammad Riaz, TK-I	Sigs.
67.	PJO-3642159	SM	Muhammad Asif, TK-I	Sigs.
68.	PJO-3643942	SM	Babo Khan, TK-I	Sigs.
69.	PJO-2590346	SM	Yousuf, TK-I	CMI
70.	PJO-2585801	SM	Mushtaq Hussain, TK-II	CMI
71.	PJO-2824513	SM	Muhammad Manzoor Khan, TK-I	CMI
72.	PJO-2377591	SM	Muhammad Ishaq, TK-I	CMI
73.	PJO-6394856	SM	Muhammad Jamshaid, TK-I	ASC
74.	PJO-6395259	SM	Zahid Akhtar, TK-II	ASC
75.	PJO-3254793	SM	Shoukat Ali Goraya, TK-I	ASC
76.	PJO-7345082	SM SMT	Afsar Khan, TK-I	AMC
77.	PJO-7346024	SM	Muhammad Iqbal, TK-I	AMC

S. No.	Army No.	Rank	Name	Arm/Service
78.	PJO-7349068	SM	Nazir Ahmed, TK-II	AMC
79.	PJO-6879272	SM SMT	Muhammad Aslam, TK-I	Ord.
80.	PJO-6878458	SM SMT	Tasveer Hussain Shah, TK-I	Ord.
81.	PJO-6878295	SM SMT	Khan Zaman, TK-II	Ord.
82.	PJO-6878299	SM	Abdul Hameed Khan, TK-I	Ord.
83.	PJO-7111763	SM Clk.	Asghar Ali, TK-I	EME
84.	PJO-7119622	Sub SMT.	Muhammad Farooq, TK-I	EME
85.	PJO-7124492	SM	Muhammad Jamil, TK-I	EME
86.	PJO-7113791	SM	Amir Nasir, TK-I	EME
87.	PJO-7108803	SM	Muhammad Nazir, TK-I	EME
88.	PJO-7115595	SM	Ali Muhammad, TK-I	EME
89.	PJO-7122217	SM	Dildar Hussain, TK-II	EME
90.	PJO-7112404	SM	Muhammad Nazir, TK-I	EME
91.	PJO-7120509	SM	Asmat Ullah, TK-II	EME
92.	PJO-7120764	SM	Muhammad Saeed, TK-II	EME
93.	PJO-7114115	SM	Muhammad Noman, TK-I	EME
94.	PJO-7114809	SM	Muhammad Rashid Ahmed, TK-I	EME
95.	PJO-7116363	SM	Arshad Ahmad, TK-I	EME
96.	PJO-7117191	SM	Gul Faraz Khan, TK-II	EME
97.	PJO-50651	SM	Tahir Mehmood, TK-I	AEC
98.	PJO-50882	SM	Liaqat Ali, TK-I	AEC
99.	PJO-50801	SM	Masood Ahmad Khan, TK-II	AEC

S. No.	Army No.	Rank	Name	Arm/Service
100.	MJ-407797	SM	Tanveer Hussain Shah, TK-II	MJD
101.	MJ-4076107	SM	Ehsan Ullah, TK-I	MJD
102.	MJ-469070	SM	Muhammad Ilyas, TK-I	MJD

[No. F. 4/9/D-2(A-II)/2021].

No. 319/2021 :

Mr. Jamal Ud Din, Assistant Private Secretary (BPS-16) (CNIC No. 71202-8371938-1) is granted 54 days leave on full pay, with effect from 8th March, 2021 to 30th April, 2021.

On expiry of leave, he is likely to resume his duty on the same post in Defence Division.

[No. 2/29/1996/D-32 (Admin-III)/2021].

No. 320/2021 :

The Federal Government in terms of Section 19 of PAF Act, 1953 has approved dismissal from service of Flt. Lt. Waseem Haider (Pak/9197) AD, with effect from 7th December, 2020.

[No. AHQ/22617/3/JAG(PC-63)/20/7/1/D-10(AF-II)/2021].

No. 321/2021 :

The names of following officers have been changed as under :-

For	Read
PA-35585 Brig. Shaukat Naeem	PA-35585 Brig. Shaukat Naeem Khan
PA-32714 Col. Ejaz Ahmad	PA-32714 Col. Ejaz Ahmed
PA-33467 Col. Muhammad Siddique Ahmed	PA-33467 Col. Raja Muhammad Siddique Ahmed
PA-36176 Lt. Col. Hamayun Khalil	PA36176 Lt. Col. Hamayun Khalil Jarral
PA-47300 Maj. Abdul Rehman Niazi	PA-47300 Maj. Muhammad Abdul Rehman Niazi
JSS-03457 Maj. Farkhandah	JSS-03457 Maj. Farkhandah Rashid Bajwa

[No. 4/2/D-2(A-II)/2021].

No. 322/2021 :

Mr. Muhammad Asif Mirza, Superintendent (BS-16), has been allowed to hold the current charge of the post of Section Officer (D-27) in addition to his own duties for a period of three months, with effect from 5th March, 2021 to 4th June, 2021 or till the availability of regular officer whichever is earlier.

This issues with the approval of competent authority *i.e.* Additional Secretary (Admin.).

[No. 4/1/90/D-32(Admin-III)/2021].

No. 323/2021 :

Mr. Shabbir Hussain, Section Officer (IT / P&D), Defence Division has been granted leave with full pay for 26 days from 15th March, to 9th April, 2021.

[No. 2/12/2010/D-26 (Admin-I)].

MIAN MUHAMMAD HILAL HUSSAIN, *HI(M)*,
Lt. Gen. (Retd.),
Secretary.

MINISTRY OF DEFENCE PRODUCTION

No. 324/2021 :

In pursuance of Establishment Division's Notification No. F.8/3/2020-E-I, dated 18th December, 2020, PA-29163 Major General Ghulam Jaffar has assumed the charge of the post of Additional Secretary (BPS-21), Ministry of Defence Production, Rawalpindi on 18th December, 2020.

[No. 2/10/2020/DP-2].

No. 325/2021 :

In pursuance of Establishment Division's Notification No. 40/626/2021-E-I, dated 26th February, 2021, Mr. Jamil Anwar, has assumed the charge of the post of Senior Joint Secretary (BPS-21), in Ministry of Defence Production, Rawalpindi on 26th February, 2021.

[No. 2/10/2018/DP-2].

No. 326/2021 :

In pursuance of Establishment Division's Notification No. 39/1096/2021-E-I, dated 26th February, 2021, Mr. Rehan Saleem, has relinquished the charge of the post of Joint Secretary (BPS-20), under Section 10 of Civil Servants Act, 1973, from Ministry of Defence Production, Rawalpindi on 26th February, 2021.

[No. 2/1/2020/DP-2].

No. 327/2021 :

In pursuance of Establishment Division's Notification No. 39/1096/2021-E-I, dated 26th February, 2021, Mr. Rehan Saleem, has assumed the charge of the post of Joint Secretary (BPS-20), in Ministry of Defence Production, Rawalpindi on 26th February, 2021.

[No. 2/1/2020/DP-2].

MUHAMMAD AWAIS QARNI,
Section Officer.

No. 328/2021 :

The competent authority has approved promotions of following officers of POF to BPS-20, with effect from 26th February, 2021 :-

S. No.	PL No. & Name	Promoted as
a.	No. 986844 Mr. M. Yasin	Director Admin
b.	No. 986745 Mr. Shoukat Hussain	MD Chemical
c.	No. 986117 Mr. Munawar Ahmad	MD Technical
d.	No. 99143 Dr. M. Masood	General Duty Medical Director

[No. 10/27/DP-7/2018].

MUHAMMAD TAHIR,
Section Officer.

The Gazette of Pakistan

PUBLISHED BY AUTHORITY

KARACHI, WEDNESDAY, APRIL 28, 2021

PART III

Notifications issued by the High Courts, the Federal Public Service Commission and by the Attached and Subordinate Offices of the Government of Pakistan.

AHK NATIONAL CENTRE FOR RURAL DEVELOPMENT

Islamabad, the 3rd February, 2021

No. F. 5(339)/2017-Admin.—Mr. Bilal Raza, Assistant Director (BPS-17), Akhtar Hameed Khan National Centre for Rural Development (AHKNCRD), Establishment Division Islamabad was granted 87 days leave on full pay (LFP) with effect from 19th October, 2020 to 13th January, 2021 with permission to prefix weekly holidays from 17th-18th October, 2020.

After the expiry of above leave, the officer has assumed his duties on the same post and at the same station on 14th January, 2021.

No. F. 5(346)/2018-Admin.—Mr. Hanifullah, Research Officer (BPS-17), Akhtar Hameed Khan National Centre for Rural Development (AHKNCRD), Establishment Division Islamabad was granted 15 days R&R leave in lieu of 10 days leave on full pay (LFP) with effect from 28th December, 2020 to 11th January, 2021 with permission to prefix weekly holidays from 26th-27th December, 2020.

After the expiry of above leave, the officer has assumed his duties on the same post and at the same station on 12th January, 2021.

MUHAMMAD YOUSAF,
Administrative Officer.

APPELLATE TRIBUNAL INLAND REVENUE

(Headquarters)

Islamabad, the 4th February, 2021

No. F. 1-ATP/HQ/(AD)/2021.—It is hereby notified with deep sorrow that Mrs. Shehnaz Firdous, Assistant

Registrar (BS-16) Appellate Tribunal Revenue, Lahore died during Government Service on 25th December, 2020.

Mrs. Shehnaz Firdous had been a valued officer of this office. Her behavior and attitude towards her colleagues, and general public was excellent and co-operative. Her performance was highly remarkable in the eyes of her seniors. Her services will always be remembered in good words, May Allah rest her soul in eternal peace.

Her name has been struck off from the strength of Appellate Tribunal Inland Revenue (ATIR).

ABDUL RASHEED UJJAN,
Assistant Registrar (Admn).

CENTRAL BOARD OF FILM CENSORS

Islamabad, the 1st February, 2021

No. F. 22-6/2010-CB-Admn.—Whereas, in exercise of the option to retire from Government service after completion of 25 years regular service, Malik Ahmed Nawaz, Film Inspector (BPS-16), Central Board of Film Censors, Islamabad, applied for retirement with effect from 23rd April, 2021 (AN) after availing Leave Preparatory to Retirement (LPR) for 365 days with effect from 25th April, 2020 in terms of Rule 16 of Revised Leave Rules, 1980.

And Whereas, he has completed 37 years and 5 months service without interruption and qualifies for retirement and L.P.R. for 365 days with effect from 25th April, 2020.

Now Therefore, Malik Ahmed Nawaz, Film Inspector (BPS-16), CBFC, Islamabad is allowed to proceed on Leave Preparatory to Retirement (LPR) for 365 days with effect from 25th April, 2020 to 23rd April, 2021. After expiry of L.P.R. he shall stand retired from Government Service with effect from 23rd April, 2021

(A.N) and shall be transferred to pension establishment from the said date subject to recovery of Government dues if any outstanding against him.

SHAHID H. SHAH,
Superintendent.

CENTRAL DIRECTORATE OF NATIONAL SAVINGS

Islamabad, the 3rd February, 2021

No. F. 26(1)Admn-I/2019.—In exercise of the powers delegated to the Head of the Department *vide* Establishment Division's O.M. No. 1/21/76--AR-R-II, dated 18th June, 1980, Director General, National Savings, has been pleased to appoint Mr. Talib Hussain, Assistant National Savings Officer (BS-14), Regional Directorate of National Savings, Bahawalpur, against the vacant post of National Savings Officer (BS-17), on current charge basis, with immediate effect, till retirement on superannuation or posting of National Savings Officer on regular basis, whichever is earlier.

He will draw pay in his own scale as BS-14 officer *plus* additional pay equal to 20% of his scale of pay subject to a maximum of Rs. 12,000/- per month in terms of FR-35 and provision to Section 17 of the Civil Servants Act, 1973 read with Finance Division's O.M. No. F. 1(3) Imp/2017-500, dated 3rd July, 2017.

ZAHEER ABBAS,
Joint Director (HR).

Islamabad, the 1st February, 2021

No. F. 1(391)Admn-I/2012.—Mr. Shahjahan, National Savings Officer (Current Charge) (BS-17), Regional Directorate of National Savings, Gujranwala, stand retire from Government Service with effect from 2nd March, 2021, on attaining the age of superannuation (being date of birth as 3rd March, 1961).

2. In terms of Section 18-A (i) of the Revised Leave Rules 1980, read with Finance Division's SRO No. 70(KE)/2012, dated 29th August, 2012 and O.M. dated 28th January, 2013, the competent authority has approved request for 365 days leave encashment in lieu of LPR in respect of above named officer leave pay for the purpose of encashment of LPR shall be computed on the basis of pay and allowances reckonable towards pension as shown in his last pay certificate.

No. F. 1(573)Admn-I/2013.—Mr. Ali Muhammad Channa, National Savings Officer (Current Charge) (BS-17), Regional Directorate of National Savings, Sukkur stand retire from Government Service with effect from 3rd January, 2021, on attaining the age of superannuation (being date of birth as 4th January, 1961).

2. In terms of Section 18-A (i) of the Revised Leave Rules 1980, read with Finance Division's SRO No. 70(KE)/2012, dated 29th August, 2012 and O.M. dated 28th January, 2013, the competent authority has approved request for 365 days leave encashment in lieu of LPR in respect of above named officer leave pay for the purpose of encashment of LPR shall be computed on

the basis of pay and allowances reckonable towards pension as shown in his last pay certificate.

SHAKEEL AHMED,
National Savings Officer (HR).

DIRECTORATE GENERAL OF SPECIAL EDUCATION

Islamabad, the 4th February, 2021

No. F. 1-25/2019-A-I (Pt).—Mrs. Verda Imtiaz, is appointed as Pediatrician (PPS-7) with effect from 16th October, 2020 in the Development Project "Establishment of Resource Unit for Autistic Children at National Special Education Centre for Mentally Retarded Children, Islamabad" on contract basis up to 30th June, 2021 on usual terms and conditions as mentioned in her offer of appointment *vide* No. F. 1-25/2018/A-I dated 13th October, 2020.

2. Mrs. Verda Imtiaz, has assumed the charge of the post of Pediatrician (PPS-7) in the Development Project "Establishment of Resource Unit for Autistic Children at National Special Education Centre for Mentally Retarded Children, Islamabad" with effect from 16th October, 2020.

No. PF. 16(MM)/A.II.—In terms of Clause 14 of her offer of appointment, the Secretary, Ministry of Human Rights, Islamabad has been pleased to accept the resignation tendered by Mrs. Malika Mahrukh, Speech Therapist, (PPS-07 equal to BPS-17), contractual employee, in the Development Project "Establishment of Resource Unit for Autistic Children at National Special Education Centre for Mentally Retarded Children, Islamabad" under the Directorate General of Special Education, Islamabad with effect from 2nd February, 2021, with the condition that no government dues are outstanding against her.

DR. MUHAMMAD WASEEM AKHTAR,
Deputy Director (Admn).

DIRECTORATE GENERAL OF TRAINING & RESEARCH
(CUSTOMS)

Karachi, the 4th February, 2021

No. 01 DGTR/2021.—In pursuance of Board's Notification No. 0212-C-I/2021 dated 1st February, 2021, Ms. Zeba Hai Azhar a BS-21 officer of Pakistan Customs Service has relinquished the charge of the post of Director General, Directorate General of Training & Research (Customs), Karachi with effect from 2nd February, 2021.

SAMSAM QADIR SHAH,
Assistant Director.

DIRECTORATE OF ELECTRONIC MEDIA AND
PUBLICATIONS

Islamabad, the 2nd February, 2021

No. 7-24/2010-E.—Mr. Umeed Ali Ghumro, Assistant Private Secretary (BPS-16), Regional Office DEMP, Karachi is granted 12 days leave on full pay with effect from 15th February, 2021 to 26th February, 2021

alongwith permission to affix closed holidays falling on 13th February, 2021 to 14th February, 2021 (Saturday, Sunday) and 27th February, 2021 to 28th February, 2021 (Saturday, Sunday). He is also permitted to leave the station.

After expiry of the leave Mr. Umeed Ali Ghumro, Assistant Private Secretary is likely to resume his duty on the same post and station on 1st March, 2021.

This issues with the approval of the Director General.

EHSAN ULLAH SHAHZAD,
Deputy Director (Admin).

FEDERAL DIRECTORATE OF EDUCATION

[MODEL COLLEGES WING]

Islamabad, the 28th January, 2021

No. F. 5-253/2018/MC/FDE.—The competent authority *i.e.* Secretary, Ministry of Federal Education & Professional Training, Islamabad has been pleased to accept the resignation tendered by Ms. Naheed Akhtar, Lecturer (BPS-17), Islamabad Model College for Girls, F-6/2, Islamabad with effect from 27th August, 2014.

Her name has, therefore, been struck off the strength of Islamabad Model College's set up.

PROF. M. AFTAB TARIQ,
Director (Model Colleges).

Islamabad, the 3rd February, 2021

No. F. 13-32/2018/MC/FDE/Deputt.—Consequent upon completion of period of deputation, the services of Ms. Mukhtiar Yasmin, working as Senior Teacher on deputation basis at Islamabad Model College for Girls, F-7/4, Islamabad under the Administrative Control of Federal Directorate of Education, Islamabad is hereby repatriated to her parent department *i.e.* Government Girls Higher Secondary School Chokara, District Karak Khyber Pakhtunkhwa with effect from 7th February, 2021 with the direction to report for duty to her parent department at-once under intimation to this Directorate.

This issues with the approval of Director General (Edu).

NOOR AHMAD KHAN,
Assistant Director (M.Cs).

GENERAL HEADQUARTERS, FGEI (C/G) DIRECTORATE

(IGT & E's Branch)

Rawalpindi, the 18th January, 2021

No. 04/PF-1252/90-FGEI (CA).—Mrs. Humaira Arshad, Associate Professor of Chemistry (BPS-19) FG Postgraduate College for Women, Wah Cantt is hereby granted 26 days leave on full average pay (FAP) with effect from 15th September, 2020 to 10th October, 2020 on account of private affairs.

On expiry of above leave, she was expected to resume duty at Wah.

No. 04/PF-06/Gen-FGEI (CA).—Ms. Farzana Begum, Assistant Professor (BPS-18) FG Girls Inter College, Karachi Cantt is granted 61 days leave on half average pay on medical grounds with effect from 1st October, 2020 to 30th November, 2020.

On expiry of above leave, she was expected to resume duty at Karachi.

No. 04/PF-2170/12-Gen-FGEI (CA).—Mrs. Diljeet Kour, Lecturer (BPS-17), FG Postgraduate College for Women, Kashmir Road, Rawalpindi Cantt is granted maternity leave (Pre/Post-confinement) for 90 days with effect from 2nd October, 2020 to 30th December, 2020.

This is issued in supersession of this Dte's letter of even number dated 16th October, 2020.

No. 04/PF-134/92-FGEI (CA).—Having exercise his option not to avail LPR on attaining the age of superannuation on 25th December, 2020 (AN), Mr. Anis Ahmed, Assistant Professor (BPS-18), FG Degree College, Okara Cantt is hereby granted Encashment of LPR for 263 days from 7th April, 2020 to 25th December, 2020 in accordance with Finance Division's O.M. No. F. 1(ii)-IMP/83 dated 18th August, 1983 & SRO (I)/2012 dated 29th August, 2012.

Certified that 263 days leave on full pay stands at his credit as verified by the Audit Office.

On expiry of encashment period, he will stand from Government Service and his name will be struck off from the strength of the said institution with effect from 25th December, 2020 (AN).

This is issued in supersession of this Dte's letter of even number dated 28th February, 2020.

Rawalpindi, the 20th January, 2021

No. 04/PF-167/07-FGEI (CA).—Mrs. Anila Rani, Lecturer in History (BPS-17) FG Postgraduate College for Women, Wah Cantt is granted leave of 49 days on full pay with effect from 13th January, 2020 to 2nd March, 2020 and 12 days with effect from 19th September, 2020 to 30th September, 2020 on medical grounds.

On expiry of above leave, she was expected to resume her duty at Wah.

MUHAMMAD GHAFAR, Lt. Col,
For Director General.

Rawalpindi, the 18th January, 2021

No. 04/PF-662/77-FGEI (SA).—Mrs. Gulnaz Safdar, SST, FG Public School No. 1 (Boys) Wah Cantt is hereby granted 34 days leave on full pay with effect from 9th November, 2020 to 12th December, 2020 on private affairs.

No. 04/PF-1746/77-FGEI (SA).—Mrs. Bilquis Begum, SST, FG Public School No. 5 (G) Wah Cantt is hereby granted 15 days leave on full pay with effect from 9th December, 2020 to 23rd December, 2020 on private affairs.

No. 04/PF-213/77-FGEI (SA).—Mrs. Syeda Sobia Zafar, Computer Instructor, FG Minwala Public School (Girls) Karachi Cantt. is hereby granted 45 days pre-confinement maternity leave on full pay with effect from 28th December, 2020 to 10th February, 2021.

On expiry of above leave, she will proceed on post-confinement maternity leave.

No. 04/PF-757/77-FGEI (SA).—Mrs. Humaira Sadiq, SST, FG Public School (G) Kashmir Road Rawalpindi Cantt is hereby granted 14 days leave on full pay with effect from 19th November, 2020 to 2nd December, 2020 on medical grounds.

No. 04/PF-397/77-FGEI (SA).—Ms. Robina Rashid, SST, FG Junior Public School No. 2 (2nd Shift) Gujranwala Cantt is hereby granted 72 days leave on full pay with effect from 21st July, 2020 to 30th September, 2020 on medical grounds.

No. 04/PF-2660/77-FGEI (SA).—Mrs. Shahida Ijaz, SST, FG Public School No. 1 (Girls) RA Bazar Lahore Cantt is hereby granted 06 days extension in leave on full pay with effect from 2nd November, 2020 to 7th November, 2020 on medical grounds.

Rawalpindi, the 19th January, 2021

No. 04/PF-927/77-FGEI (SA).—Mrs. Farrukh Shamim, TGT, FG Public School (G) Lalazar Rawalpindi is hereby granted 07 days leave on full pay with effect from 10th November, 2020 to 16th November, 2020 on medical grounds.

No. 04/PF-397/77-FGEI (SA).—Mrs. Rahat Tanveer, SST, FG Public School Nowshera Cantt is hereby granted 19 days leave on full pay with effect from 17th August, 2020 to 4th September, 2020 on private affairs.

No. 04/PF-139/77-FGEI (SA).—Mrs. Humaira Jamal, TGT, FG Junior Public School Mehfooz Road Rawalpindi Cantt. is hereby granted 21 days post-confinement maternity leave on full pay with effect from 18th August, 2020 to 7th September, 2020.

No. 04/PF-459/77-FGEI (SA).—Mrs. Saima, Vice Principal, FG Public School (G) Tariqabad Rawalpindi is hereby granted 82 days pre/post-confinement maternity leave on full pay with effect from 2nd October, 2020 to 22nd December, 2020.

No. 04/PF-355/77-FGEI (SA).—Mrs. Shumaila Noureen, SST (Deputationist), FG Public School No. 1 (G) Bahawlpur Cantt is hereby granted 07 days leave on full pay with effect from 14th November, 2020 to 20th November, 2020 on medical grounds.

No. 04/PF-688/77-FGEI (SA).—Mrs. Attia Kousar, TGT, FG Junior Public School No. 4 (2nd Shift) Wah Cantt is hereby granted 11 days leave as EOL without pay with effect from 7th October, 2020 to 17th October, 2020 on private affairs.

No. 04/PF-776/77-FGEI (SA).—Mrs. Laila Zameer, SST, FG Minwala Public School (Girls) Karachi Cantt is hereby granted 15 days leave as EOL without pay with effect from 19th October, 2020 to 2nd November, 2020 on medical grounds.

No. 04/PF-874/77-FGEI (SA).—Mst. Uzma Riaz, TGT, FG Junior Public School No. 6 Gujranwala Cantt is hereby granted special/iddat leave on full pay for 130 days with effect from 15th May, 2020 to 23rd September, 2020.

No. 04/PF-303/77-FGEI (SA).—Mrs. Hina Parveen, TGT, FG Sir Syed Public School (G) Rawalpindi is hereby granted 43 days post-confinement maternity leave on full pay with effect from 12th November, 2020 to 24th December, 2020.

No. 04/PF-3018/77-FGEI (SA).—Mrs. Shabnam Shahida, TGT, FG Public School No. 3 (G) 2nd Shift Multan, is hereby granted 07 days leave on full pay with effect from 9th November, 2020 to 9th November, 2020 on medical grounds.

No. 04/PF-599/77-FGEI (SA).—Mrs. Shazia Bibi, TGT, FG Junior Public School Kashmir Road Rawalpindi is hereby granted 45 days post-confinement maternity leave on full pay with effect from 20th September, 2020 to 3rd November, 2020.

No. 04/PF-976/77-FGEI (SA).—Mrs. Qamar Fatima, TGT, FG Jinnah Public Junior School No. 2 G/Line Chaklala Rawalpindi, is hereby granted 15 days leave on full pay with effect from 3rd September, 2020 to 17th September, 2020 on medical grounds.

No. 04/PF-379/77-FGEI (SA).—Consequent upon her request for grant of premature retirement from Govt. Service on completion of 30 years qualifying service for pension, Mrs. Zeba Yasir, SST, FG FPS School (2nd Shift) PAF Base Nur Khan Rawalpindi is hereby granted 192 days Encashment in lieu of LPR with effect from 1st April 2020 to 9th October, 2021 in accordance with Finance Division's O.M. No. F. 1(7)R-4/2004 dated 29th August, 2012.

Certified that 192 days leave on full pay is due at her credit verified by PAO.

She will stand retired from Government Service and her name will be struck off the strength of said school with effect from 9th October, 2021 (AN).

No. 04/PF-1323/77-FGEI (SA).—Having exercised the option not to avail LPR on attaining the age of superannuation i.e. 60 years on 1st February, 2022, Mrs. Nasreen Younas, TGT, FG Public Middle School Sikandarabad Abbottabad is hereby granted Encashment in lieu of LPR for 16 days with effect from 17th January, 2022 to 1st February, 2022 in accordance with Finance Division's O.M. No. F. 1(7) R-4/2004 dated 29th August, 2012.

2. Certified that 16 days leave on full pay is due stands at her credit as verified by PAO.

She will stand retired from Government Service and her name will be struck off the strength of said school with effect from 1st February, 2022 (AN).

Rawalpindi, the 20th January, 2020

No. 04/PF-937/77-FGEI (SA).—Mrs. Noor Fatima, SST, FG Public School No. 2 (Girls) Gujranwala Cantt. is hereby granted 45 days pre-confinement maternity

leave on full pay with effect from 4th November, 2020 to 18th December, 2020.

Rawalpindi, the 26th January, 2021

No. 04/PF-1652/77-FGEI (SA).—Mrs. Shehla Gul, Computer Instructor, FG Model Public School Wah Cantt is hereby granted 02 days leave on full pay with effect from 25th August, 2020 to 28th August, 2020 on private affairs.

Rawalpindi, the 27th January, 2021

No. 04/PF-1814/77-FGEI (SA).—Mrs. Gul-e-Nargis, TGT, FG Public School No. 7 (Girls) Wah Cantt is hereby granted 15 days leave on full pay with effect from 26th October, 2020 to 9th November, 2020 on medical grounds.

No. 04/PF-1725/77-FGEI (SA).—Mrs. Tahira Jabeen, SST, FG Junior Public School CAD Havelian Cantt is hereby granted 27 days post- confinement maternity leave on full pay with effect from 13th January, 2021 to 8th February, 2021.

On expiry of above leave, she is expected to resume her duty in the same school at Havelian Cantt.

No. 04/PF-809/77-FGEI (SA).—Mrs. Qurat ul Ain, SST, FG Public School No. 2 (Boys) Sialkot Cantt. is hereby granted 45 days pre-confinement maternity leave on full pay with effect from 13th November, 2020 to 27th December, 2020.

No. 04/PF-107/77-FGEI (SA).—Having exercise the option not to avail LPR on attaining the age of superannuation *i.e.* 60 years on 2nd January, 2021, Mrs. Shahida Khanum, SST, FG JAS Public School PMA Kakul Abbottabad Cantt is hereby granted Encashment in lieu of LPR for 314 days with effect from 24th February, 2020 to 2nd January, 2021 in accordance with Finance Division's O.M. No. F. 1(7) R-4/2004 dated 29th August, 2012.

Certified that 314 days leave on full pay is due at her credit as verified by PAO.

She will stand retired from Government Service and her name will be struck off the strength of said school with effect from 2nd January, 2021 (AN).

This Dte letter of even number dated 11th January, 2021 may be treated as cancelled.

SUNDAS GUL *Maj*,
For Director General.

Rawalpindi, the 18th January, 2021

No. 04/PF-94/77-FGEI (M).—Mr. Mahmood Anwar, Principal, FG Public School (Boys) Abbottabad Cantt. is hereby granted leave on full pay for 30 days from 5th January, 2021 to 3rd February, 2021 on private affairs.

No. 04/PF-03/77-FGEI (M).—On attaining the age of superannuation *i.e.* 60 years Mr. Abdul Salam, SST, FG Public School No. 2 (Boys) Tariqabad Rawalpindi is hereby granted 204 days Encashment in lieu LPR with effect from 23rd September, 2020 to 14th April, 2021

in accordance with Finance Division O.M. No. F. 1 (7)R-4/2004 dated 29th August, 2012.

Certified that 204 days leave on full pay stands at his credit.

He will be retired form Govt. service and his name will be struck off the strength of school with effect from 14th April, 2021 (AN).

Rawalpindi, the 19th January, 2021

No. 04/PF-22/77-FGEI (M).—Mr. Shakeel Ahmed, SST, FG Public School Karachi Cantt. is hereby granted Quarantine leave on full pay for 49 days from 28th July, 2020 to 14th September, 2020 on private affairs.

No. 04/PF-499/77-FGEI (M).—Mr. Abid Khan, SST, FG Public School D. I. Khan is hereby granted leave on full pay for 07 days from 10th November, 2020 to 16th November, 2020 on medical grounds.

No. 04/PF-145/77-FGEI (M).—Mr. Nayyar Khalid, SST, FG Sir Syed Public School (Boys) Rawalpindi Cantt. is hereby granted leave on full pay for 15 days from 9th November, 2020 to 23rd November, 2020 on medical grounds.

No. 04/PF-08/77-FGEI (M).—On attaining the age of superannuation Mr. Ghulam Farid VP (BPS-18), FG Junior Public School Gudwal Wah Cantt. is hereby granted 365 days Encashment in lieu of LPR with effect from 10th December, 2020 to 9th December, 2021 in accordance with Finance Division O.M. No. F. 1 (7)R-4/2004 dated 29th August, 2012.

Certified that 365 days leave on full pay stands at his credit.

He will be retired form Govt. service and his name will be struck off the strength of school with effect from 9th December, 2021 (AN).

Rawalpindi, the 21st January, 2020

No. 04/PF-29/77-FGEI (M).—Mr. Muhammad Irshad, SST, FG Junior Public School Mardan is hereby granted leave on full pay for 14 days from 11th November, 2020 to 24th November, 2020 on medical grounds.

ALI RAZA SHAH *Maj*,
For Director General.

GEOLOGICAL SURVEY OF PAKISTAN

Quetta, the 3rd June, 2020

No. Estt-I-814/PF.—Mr. Umar Farooq, Assistant Director, Geological Survey of Pakistan, Quetta is granted 12 days leave on full pay from 11th May, 2020 to 22nd May, 2020 (with permission to leave the station) subject to title.

On expiry of the leave, the officer is likely to assume his duty on the same post and station.

No. Estt-I-809/PF.—Mr. Muhammad Usman, Assistant Director, Geological Survey of Pakistan, Quetta is

granted 12 days leave on full pay from 11th May, 2020 to 22nd May, 2020 (with permission to leave the station) subject to title.

On expiry of the leave, the officer is likely to assume his duty on the same post and station.

Quetta, the 4th June, 2020

No. Estt-I-873/PF.—Mr. Hamid Hanif, Assistant Director, Geological Survey of Pakistan, Quetta is granted 22 days leave on full pay from 3rd April, 2020 to 24th April, 2020 (with permission to leave the station) subject to title.

On expiry of the leave, the officer is likely to assume his duty on the same post and station.

No. Estt-I-872/PF.—Mr. Arslan Qaiser, Assistant Director, Geological Survey of Pakistan, Quetta is granted 22 days leave on full pay from 3rd April, 2020 to 24th April, 2020 (with permission to leave the station) subject to title.

On expiry of the leave, the officer will assume his duty on the same post and station.

Quetta, the 29th June, 2020

No. Estt-I-592/PF.—Mr. Waseemuddin, Superintendent, Geological Survey of Pakistan, Quetta is granted 15 days leave on full pay from 16th June, 2020 to 30th June, 2020.

On expiry of the leave, the officer is will assume his duty on the same post and station.

No. Estt-I-691/PF.—Mr. Ahmed Sultan, Superintendent, Geological Survey of Pakistan, Quetta is granted 15 days R&R leave on full pay from 23rd June, 2020 to 7th July, 2020, subject to title.

On expiry of the leave, the officer will assume his duty on the same post and station.

ZAHID HUSSAIN KHAN,
Assistant Director (Admn).

INTELLECTUAL PROPERTY ORGANISATION OF
PAKISTAN

Islamabad, the 2nd February, 2021

No. 98/HR/IPO-Pak/2020.—In supersession of IPO-Pakistan's earlier notification of even number dated 30th December, 2020 and in pursuance of the Ministry of Commerce Notification No. 15(23)/2009-A-III/CTG dated 10th December, 2020, Mr. Mueed Aman Rana, a BS-18 officer of the Commerce & Trade Group, has assumed the charge of the post of the Deputy Director (BS-18) at the IPO-Pakistan Head Office, Islamabad on deputation basis for a period of three (03) years on standard terms & conditions with effect from 10th December, 2020.

Islamabad, the 3rd February, 2021

No. 100/HR/IPO-Pak/2021.—In pursuance of the Ministry of Commerce's Notification No. 15(11)/2010-Admn-III/CTG dated 21st January, 2021, Ms. Asma Khattak, a

BS-18 officer of the Commerce & Trade Group, has assumed the charge of the post of Deputy Director (BS-18) at IPO-Pakistan Head Office, Islamabad on deputation basis for a period of three (03) years on standard terms & conditions with effect from 22nd January, 2021.

HUMAIRA SHAKIR,
Assistant Director (HR).

ISLAMABAD HIGH COURT

Islamabad, the 4th February, 2021

No. PF. (86)/JO/Conf./IHC/915.—The Hon'ble Chief Justice as the competent authority has been pleased to accept the resignation of Syed Sabee-ul-Hassan, Civil Judge-*cum*-Judicial Magistrate, Islamabad, with effect from 3rd February, 2021, in the public interest.

SAJID BALOCH,
Registrar.

Islamabad, the 1st February, 2021

No. PF. (23)/JO/Conf./IHC/911.—In continuation of this office earlier Notification No. PF (23)/JO/Conf./IHC/906, dated 23rd January, 2021, the competent authority of this Court has been pleased to extend the earned leave of Mr. Muhammad Sohail, Additional District & Sessions Judge (BPS-20), West-Islamabad for further seven (7) days with effect from 24th January, 2021 to 30th January, 2021, with full pay (without Car/Conveyance Allowance).

Islamabad, the 6th February, 2021

No. F. (25)/HJ/Conf./IHC/918.—The Hon'ble Chief Justice has been please to grant 16-days *ex*-Pakistan leave in favour of Hon'ble Mr. Justice Babar Sattar, Judge, Islamabad High Court, Islamabad with effect from 5th March, 2021 to 20th March, 2021.

NEELAM JEHAN KHAN,
Assistant Registrar (Conf.).

JINNAH POSTGRADUATE MEDICAL CENTRE

Karachi, the 31st January, 2021

No. PF. 2-250/ZA/Admn-1/JPMC.—Mr. Zahir Ali S/o. Shair Ghani, Charge Nurse of this Centre has been granted LFP for 20 days with effect from 16th December, 2020 to 5th January, 2021, on medical grounds, subject to title.

He has resumed his duty on 6th January, 2021.

No. PF. 2-453/IS/Admn-1/JPMC.—Mst. Ishrat Sultana D/o. M. Ishaque, Charge Nurse of this Centre has been granted LFP for 07 days with effect from 4th January, 2021 to 10th January, 2021 on medical grounds, subject to title.

She has resumed her duty on 11th January, 2021.

Karachi, the 22nd January, 2021

No. PF. 2-370/S/Admn-1/JPMC.—Mst. Samina D/o. Farooq, Charge Nurse of this Centre has been granted LFP for 02 days with effect from 27th December, 2020 to 28th December, 2020, combined with EOL (without pay and allowances) for 06 days with effect from 29th December, 2020 to 3rd January, 2021, subject to title.

She has resumed her duty on 4th January, 2021.

No. PF. 2-342/FM/Admn-1/JPMC.—Mst. Farzana Mufti D/o. Mufti Abdul Qahar, Charge Nurse of this Centre has been granted EOL (without pay and allowances) for 05 days with effect from 4th January, 2021 to 8th January, 2021.

She has resumed her duty on 9th January, 2021.

No. PF. 2-362/AS/Admn-1/JPMC.—Mr. Ahtsham Shahzad S/o. Daniel Gill, Charge Nurse of this Centre has been granted LFP for 04 days with effect from 7th January, 2021 to 10th January, 2021, on medical grounds, subject to title.

He has resumed his duty on 11th January, 2021.

No. PF. 2-251/YAK/Admn-1/JPMC.—Mr. Younis Aijaz Khan, Charge Nurse of this Centre has been granted LFP for 10 days with effect from 4th January, 2021 to 13th January, 2021, subject to title.

He has resumed his duty on 14th January, 2021.

No. PF. 2-106/GJ/Admn-1/JPMC.—Mst. Ghazala Jabeen D/o. Ashfaq Hussain, Charge Nurse of this Centre has been granted LFP for 04 days with effect from 2nd January, 2021 to 5th January, 2021, on medical grounds subject to title.

She has resumed her duty on 6th January, 2021.

No. PF. 2-201/SA/Admn-1/JPMC.—Mst. Shaheen Akhtar D/o. Lal Din, Charge Nurse of this Centre has been granted LFP from 30th October, 2020 to 14th January, 2021, on medical grounds subject to title.

She has resumed her duty on 15th January, 2021.

No. PF. 2-283/MS/Admn-1/JPMC.—Mr. Muhammad Shahnawaz S/o. Abdul Maroof, Charge Nurse of this Centre has been granted LFP for 03 days with effect from 11th January, 2021 to 13th January, 2021, combined with EOL (without pay and allowances) for 02 days with effect from 14th January, 2021 to 15th January, 2021, subject to title.

He has resumed his duty on 16th January, 2021.

No. PF. 2-454/NB/Admn-1/JPMC.—Mst. Nasreen Bano D/o. Taj Muhammad, Charge Nurse of this Centre has been granted LFP for 10 days with effect from 4th January, 2021 to 13th January, 2021, on medical grounds subject to title.

She has resumed her duty on 14th January, 2021.

No. PF. 2-222/SN/Admn-1/JPMC.—Mst. Sofia Noreen D/o. Iqbal Masih, Charge Nurse of this Centre has been

granted LFP for 07 days with effect from 28th December, 2020 to 3rd January, 2021, subject to title.

She has resumed her duty on 4th January, 2021.

DR. SEEMIN JAMALI, *Ti.*,
Executive Director.

MODEL CUSTOMS COLLECTORATE APPRAISEMENT
AND FACILITATION (EAST)

Karachi, the 3rd February, 2021

No. P.F. 2(689)/2021-MCC-A&F (East).—In pursuance of Office of the Chief Collector of Customs, Appraisal and Facilitation (South)'s Office Order No. 01/2021-ESTT (CC-Appr) dated 30th January, 2021, Mr. Muhammad Umair Makki, Appraising Officer (BS-16) Officer of Customs Department, has assumed the charge of the post of Appraising Officer (BS-16), at MCC Appraisal and Facilitation (East), Custom House, Karachi, with effect from 2nd February, 2021.

No. P.F. 2(601)/2018-MCC-A&F (East).—In pursuance of Office of the Chief Collector of Customs, Appraisal and Facilitation (South)'s Office Order No. 01/2021-ESTT (CC-Appr) dated 30th January, 2021, Mr. Shahrukh Akhlaq Siddiqui, Principal Appraiser (BS-16) Officer of Customs Department, has relinquished the charge of the post of Principal Appraiser (BS-16), from the MCC Appraisal and Facilitation (East), Custom House, Karachi, on 1st February, 2021.

SHAHZAD ALI,
Assistant Collector HQs.

MODEL CUSTOMS COLLECTORATE OF ENFORCEMENT
& COMPLIANCE

Karachi, the 2nd February, 2021

No. 04/2021-Estt (P).—After completion of 28th Senior Management Course *vide* National Institute Management (NIM) Karachi Notification No. 13/4/2020 NIM dated 29th January, 2021 Mr. Omar Shafique (BS-19), has assumed the charge of the post of Additional Collector of Customs (BS-19), Model Customs Collectorate (Enforcement & Compliance), Custom House, Karachi, with effect from 30th January, 2021.

SHAFI ULLAH,
Assistant Collector (HQ-I).

OFFICE OF THE CHIEF ENGINEERING ADVISER/
CHAIRMAN FEDERAL FLOOD COMMISSION

Islamabad, the 24th December, 2020

No. F. 8(147)/05-Admn.—Mr. Muhammad Aksar, Assistant Private Secretary (BS-16) (Personnel No. 50014318) of this office is granted 19 days leave on full pay with effect from 14th December, 2020 to 1st January, 2021.

After expiry of the above leave, he is likely to resume his duty on the same post at the same station on 4th January, 2021 (2nd & 3rd January, 2021, being closed holidays).

MUHAMMAD MUNIR,
Deputy Director (A&A).

Islamabad, the 3rd December, 2020

No. F. 7(88)/92-Admn.—Mr. Ather Hameed, Engineering Adviser (Civil) BS-20 of this office is granted 12 days Quarantine leave due to suffering from "Corona Virus" to be treated as extra casual leave outside his leave account with effect from 16th November, 2020 to 27th November, 2020 as admissible under the Revised Leave Rules, 1980.

After expiry of the above leave, he has resumed his duty on the same post at the same station on 30th November, 2020 (28th & 29th November, 2020).

Islamabad, the 17th December, 2020

No. F. 7(120)/03-Admn.—Mr. Abdul Rashid Shah, Sub Engineering (BPS-16) (Personnel No. 50064901) of this office is granted 26-days leave on full pay with effect from 19th November, 2020 to 14th December, 2020.

After expiry of the above leave, he has resumed the charge of the same post at the same station on 15th December, 2020 (Tuesday).

Islamabad, the 11th January, 2021

No. F. 7(158)/09-Admn.—On completion of 30 years, 08 months and 26 days qualifying service as on 4th October, 2021 and after having the approval of the Secretary, Water Resources, being the competent authority *vide* Ministry of Water Resources Letter No. F. 3(31)/2016-CEA/CCFC, dated 23rd December, 2020, Malik Imtiaz Farooq, Social Mobilizer (BPS-18) of this office shall stand retired from Government Service on 5th October, 2021, on attaining the age of superannuation *i.e.* 60 years with 365 days leave encashment in lieu of LPR starting from 5th October, 2020 to 4th October, 2021.

Islamabad, the 19th January, 2021

No. F. 8(162)/10-Admn.—Mr. Muhammad Amin, APS (BPS-16) (Personnel No. 50092452) of this office is granted 12 days leave on full pay with effect from 4th January, 2021 to 15th January, 2021.

After expiry of the above leave he has resumed his duty on the same post at the same station on 18th January, 2021 (16th-17th January, 2021 closed holidays).

Islamabad, the 21st January, 2021

No. F. 7(166)/09-Admn.—The unauthorized absence of Mr. Muhammad Amin, Assistant Engineer (Floods) (BS-17) of this office for 32 days with effect from 9th November, 2020 to 10th December, 2020 treated as without pay and allowances.

After expiry of the above period he has resumed the charge of the same post at the same station on 11th December, 2020.

Islamabad, the 25th January, 2021

No. F. 7(172)/18-Admn.—Mr. Sibite Hassan, Assistant Engineer (Floods) (BPS-17) (Personnel No. 500195454) of this office is granted 11 days leave on full pay with effect from 14th December, 2020 to 24th December, 2020.

After expiry of the above leave he has resumed the charge on the same post at the same post at the same station on 28th December, 2020 (25th to 27th December, 2020 being closed holidays).

SYED MOHSIN RAZA SHAH,
Administrative Officer.

OFFICE OF THE DIRECTOR GENERAL FEDERAL
INVESTIGATION AGENCY

Islamabad, the 2nd February, 2021

No. A/P-I/Admn(N)/2021.—The following officers are hereby transferred and posted, with immediate effect and till further orders.

S#	Name	From	To
1.	Syed Arif Ali Shah, PS (BPS-17)	Office of ADG North, Lahore	Attached in FIA CBC, Punjab Zone-I, Lahore
2.	Raja Shahzad, Inspector (BPS-16)	Office of ADG North, Lahore	FIA ACC, Punjab Zone-I, Lahore
3.	Sumbal Rana, Inspector (BPS-16)	FIA ACC, Punjab Zone-I, Lahore	FIA EGOA Unit, Punjab Zone-I, Lahore

2. This is issued with the approval of Additional Director General (North).

ADEEL ABBAS,
Deputy Director Coord.

OFFICE OF THE INSPECTOR GENERAL FRONTIER
CORPS BALOCHISTAN

Quetta, the 23rd January, 2021

No. 101-9/Cfm/113/E-2-CONFIRMATION.—On completion of one year probationary period, following Junior Commissioned Officers of Frontier Corps Balochistan (North) are hereby confirmed in their present rank with effect from the dates noted against each :-

1. No 17838 Subedar (General Duty) Ashfaq Hussain, Punjabi of Bambore Rifles with effect from 4th December, 2020.
2. No 5620 Subedar (Observer) Muhammad Riaz, Pathan of Sui Rifles with effect from 31st August, 2019.
3. No 30378 Subedar (General Duty) Noor Aslam Khan, Pathan of Chaman Scouts with effect from 22nd December, 2019.

4. No 12119 Naib Subedar (General Duty) Shujat Ali, Pathan of Bambore Rifles with effect from 1st January, 2020.
5. No 44872 Naib Subedar (General Duty) Muhammad Ramzan, Baloch of Bambore Rifles with effect from 27th April, 2020.
6. No 7263 Naib Subedar (Gunner) Muhammad Saleem, Punjabi of Chaman Scouts with effect from 31st May, 2020.
7. No 5687 Naib Subedar (General Duty) Muhammad Ramzan, Punjabi of Sui Rifles with effect from 1st September, 2020.
8. No 26819 Naib Subedar (General Duty) Waseem Shah, Pathan of Maiwand Rifles with effect from 2nd July, 2020.
9. No 31866 Naib Subedar (Pioneer) Khan Laiq Khan, Pathan of Ghazaband Scouts effect from 10th January, 2021.
10. No 5266 Subedar (General Duty) Abdul Munir, Punjabi of Chiltan Rifles with effect from 1st October, 2020.
11. No 33527 Naib Subedar (General Duty) Abdul Hameed, Baloch of Ghazaband Scouts effect from 1st January, 2020.
12. No 1092 Naib Subedar (Painter) Maqsood Anwar, Pathan of Electrical Mechanical Engineering Branch effect from 3rd July, 2020.
7. Number 901825 Subedar Fazal Tawab of Dir Scouts with effect from 19th August, 2020.
8. Number 902269 Naib Subedar Sarfaraz Khan of Dir Scouts with effect from 30th September, 2019.
9. Number 902135 Naib Subedar Anwar Ali of Dir Scouts with effect from 22nd February, 2020.
10. Number 902318 Naib Subedar Muhabbad Khan of Dir Scouts with effect from 19th August, 2020.
11. Number 902108 Naib Subedar Niaz Amin of Dir Scouts with effect from 30th September, 2020.
12. Number 902549 Naib Subedar Muhammad Javed of Dir Scouts with effect from 5th August, 2020.

Peshawar, the 31st January, 2021

No. 22/Prom/33/RW.—The following promotions are ordered :-

TO BE SUBEDAR MAJOR ON PROBATION OF SIX MONTHS

1. No. 404158 Subedar Shoaib of 142 Wing Chitral Scouts with effect from 15th August, 2020, *vice* No. 403917 Subedar Major Azmat Ullah transferred to Headquarters Wing Chitral Scouts on Extra Regiment Employment Duty with effect from 15th August, 2020.
2. No. 80436 Subedar (Electrician) Hidayat Ur Rehman (Electrical Mechanical Engineering Establishment) of Headquarters Frontier Corps Khyber Pakhtunkhwa (North) with effect from 2nd December, 2020 *vice* No. 80416 Subedar Major Zahoor Ahmed Bhatti proceeded on pension with effect from 1st December, 2020.
3. No. 502988 Subedar Said Ghawas of 233 Wing Orakzai Scouts with effect from 14th March, 2020, *vice* No. 103766 Subedar Major Islam Khan transferred to Headquarters Wing Orakzai Scouts on Extra Regiment Employment Duty with effect from 14th March, 2020.

TO BE SUBEDAR ON PROBATION OF SIX MONTHS

1. Number 901974 Subedar Muhammad Khan of Dir Scouts with effect from 30th June, 2020.
2. Number 503575 Subedar Nasib Gul of Dir Scouts with effect from 18th February, 2020.
3. Number 901970 Subedar Khial Khan of Dir Scouts with effect from 2nd August, 2020.
4. Number 1102964 Subedar Abdur Rehman of Dir Scouts with effect from 9th August, 2020.
5. Number 901594 Subedar Sabzali Khan of Dir Scouts with effect from 22nd February, 2020.
6. Number 1200502 Subedar Shah Wali Khan of Dir Scouts with effect from 24th August, 2020.
4. No. 404599 Naib Subedar Fazale Nabi of 145 Wing Chitral Scouts (Settle District) with effect from 1st September, 2020 *vice* No. 404167 Subedar Gul Akbar proceeded on pension with effect from 31st August, 2020.
5. No. 901608 Naib Subedar Noor Muhammad of 181 Wing Dir Scouts (Settle District) with effect from 19th January, 2020 *vice* No. 901324 Subedar Ghulam Farid Khan proceeded on pension with effect from 18th January, 2020.
6. No. 80519 Naib Subedar (Armourer) Musa Wali Khan (Electrical Mechanical Engineering Establishment) of Headquarters Frontier Corps Khyber Pakhtunkhwa (North) with effect from 5th August, 2020 *vice* No. 80422 Subedar (Armourer)

FAISAL AZAD KAYANI, *Major,*
For Inspector General.

OFFICE OF THE INSPECTOR GENERAL FRONTIER
CORPS KHYBER PAKHTUNKHWA

Peshawar, the 26th January, 2021

No. 25/Cfm/DS/X/RW.—On completion of probationary period of six months, under mentioned Junior Commissioned Officers are confirmed in their present rank from the date as noted against each :-

- Fida Hussain proceeded on pension with effect from 4th August, 2020.
7. No. 902123 Naib Subedar Umerin Khan of 181 Wing Dir Scouts (Settle District) with effect from 28th September, 2020 *vice* No. 203006 Subedar Farman Ullah proceeded on pension with effect from 27th September, 2020.
 8. No. 1200571 Naib Subedar Shamshad Khan of 105 Wing Khyber Rifles (Settle District) with effect from 14th September, 2019 from the date of confirmation on creation of vacancy in Battalion system in Settle District of 105 Wing Khyber Rifles with effect from 1st April, 2019.
 9. No. 902131 Naib Subedar Alam Zeb of 101 Wing Khyber Rifles (Settle District) with effect from 12th December, 2020 after completion of six months deferment period *vice* No. 503115 Subedar Israr Hussain proceeded on pension with effect from 26th December, 2019.
 10. No. 1200552 Naib Subedar Muhammad Ilyas of 211 Wing Tirah Rifles (Settle District) with effect from 13th November, 2020 after completion of deferment period *vice* No. 1200025 Subedar Sakhi Muhammad transferred to Scouts Training Academy on Extra Regiment Employment duty with effect from 1st April, 2020.
 11. No. 1102885 Naib Subedar Watan Khan of 207 Wing Mohmand Rifles (Settle District) with effect from 25th November, 2020 after completion of six months deferment period on rotation vacancy of Subedar between Settle & Tribal District in new raising 207 Wing Mohmand Rifles with effect from 1st June, 2019.
 12. No. 802177 Naib Subedar Tasreer Khan of 171 Wing Bajaur Scouts (Settle District) with effect from 5th March, 2020 *vice* No. 801552 Subedar Sher Alam promoted Subedar Major with effect from 5th March, 2020.
 13. No. 702522 Naib Subedar Azmat Ali Khan of 166 Wing Bara Rifles (Settle District) with effect from 10th January, 2021 *vice* No. 702025 Subedar Sher Alam proceeded on pension with effect from 9th January, 2021.
 14. No. 702565 Naib Subedar Noor Jamal of 166 Wing Bara Rifles (Tribal District) with effect from 27th January, 2021 *vice* No. 103702 Subedar Nabi Shah proceeded on pension with effect from 26th January, 2021.
- TO BE NAIB SUBEDAR ON PROBATION OF SIX MONTHS*
15. No. 405197 Havildar Ishq-e-Ilahi of 142 Wing Chitral Scouts (Settle District) with effect from 11th April, 2020 from the date of qualification *vice* No. 404554 Naib Subedar Shahbaz Khan promoted Subedar with effect from 1st January, 2019.
 16. No. 405064 Havildar Muhammad Khan of 142 Wing Chitral Scouts (Tribal District) with effect from 16th August, 2020 *vice* No. 404550 Naib Subedar Muhammad Ishaq proceeded on pension with effect from 15th August, 2020.
 17. No. 405272 Havildar Atiq Ur Rehman of 142 Wing Chitral Scouts (Settle District) with effect from 11th April, 2020 from the date of qualification *vice* No. 404592 Naib Subedar Iqbal Ud Din promoted Subedar with effect from 15th February, 2020.
 18. No. 203647 Havildar Saddiq Khan of 166 Wing Chitral Scouts (Tribal District) with effect from 20th January, 2020 from the date of qualification *vice* No. 702417 Naib Subedar Nooruz Khan promoted Subedar with effect from 1st June, 2019.
 19. No. 80557 Havildar (Armourer) Momin Khan (Electrical Mechanical Engineering Establishment) of Headquarters Frontier Corps Khyber Pakhtunkhwa (North) with effect from 5th August, 2020 *vice* No. 80519 Naib Subedar (Armourer) Musa Wali Khan promoted Subedar with effect from 5th August, 2020.
 20. No. 504783 Havildar Ijaz Mahmood of 102 Wing Khyber Rifles (Settle District) with effect from 1st April, 2019 on creation of vacancy in Battalion system with effect from 1st April, 2019.
 21. No. 504492 Havildar Ghufuran Ullah (Signal Establishment) of 107Wing Khyber Rifles with effect from 1st July, 2020 in existing vacancy of new raised 107 Wing Khyber Rifles with effect from 1st July, 2020.
 22. No. 802561 Havildar Gul Nazir of 216 Wing Tirah Rifles (Tribal District) with effect from 5th December, 2020 after completion of deferment period *vice* No. 504487 Naib Subedar Farid Ullah transferred to Headquarters Wing on Extra Regiment Employment duty with effect from 1st April, 2020.
 23. No. 1103370 Havildar Shah Ahmad of 207 Wing Mohmand Rifles (Settle District) with effect from 21st April, 2020 from the date of qualification in existing vacancy on new raising of 207Wing Mohmand Rifles.
 24. No. 1104244 Havildar Muslim Khan of 202 Wing Mohmand Rifles (Settle District) with effect from 25th April, 2020 *vice* No. 1200610 Naib Subedar Imtiaz Khan proceeded on pension with effect from 24th April, 2020.
 25. No. 1104319 Havildar Nasib Shah of 202 Wing Mohmand Rifles (Settle District) with effect from 8th July, 2020 *vice* No. 702356 Naib Subedar Sabz Ali promoted Subedar with effect from 8th July, 2020.
 26. No. 1103322 Havildar Sarbaz Khan of Field Battery Mohmand Rifles with effect from 1st September, 2020 against higher rank of Subedar *vice* No. 1102698 Naib Subedar Bahadar Khan proceeded on pension with effect from 31st August, 2020.

27. No. 902261 Havildar Habib Khan of 181 Wing Dir Scouts (Settle District) with effect from 7th January, 2021 after completion of 6 months deferment period vice No. 901608 Naib Subedar Noor Muhammad promoted Subedar with effect from 19th January, 2020.
28. No. 405124 Havildar Mulki Azam of 186 Wing Dir Scouts (Settle District) with effect from 5th December, 2020 after completion of 6 months deferment period vice No. 901850 Naib Subedar Khaista Malik promoted Subedar with effect from 1st February, 2020.
29. No. 505504 Havildar Allama Iqbal of 233 Wing Orakzai Scouts (Settle District) with effect from 22nd January, 2020 on creation of vacancy in battalion system in 233 Wing Orakzai Scouts Settle District with effect from 1st April, 2019.

MUHAMMAD IMRAN, *Lieutenant Colonel*,
Officer Incharge Records.

OFFICE OF PAKISTAN COMMISSIONER FOR INDUS
WATERS

Islamabad, the 2nd February, 2021

No. PCIW/PF-1(133)/2018-Admn/9.—Competent Authority (Head of the Department) has been pleased to grant additional charge in additional to his own duties against the leave vacancy of Assistant Commissioner for Indus Waters (BS-17) for a period from 14th September, 2020 to 28th February, 2021.

This issues with the approval of Pakistan Commissioner for Indus Waters.

Islamabad, the 4th February, 2021

No. PCIW/7(3)/2020-Admn/26.—Consequent upon the recommendation of Departmental Promotion Committee in its meeting held on 4th February, 2021 and with the approval of Secretary, Ministry of Water Resources being the appointing authority of BS-17 to BS-19, Mr. Shaukat Ali, Assistant Private Secretary (BS-16) is hereby promoted as Private Secretary (BS-17) in the office of Pakistan Commissioner for Indus Waters with immediate effect.

ZAHID HUSSAIN,
Deputy Director (Admn).

PAKISTAN POST

[DIRECTORATE GENERAL PAKISTAN POST]

Islamabad, the 4th February, 2021

No. CP. 5-10/2003-XVI.—On the recommendations of the Departmental Promotion Committee and with the approval of the competent authority viz Deputy Director General (Admn), Directorate General, Pakistan Post, Islamabad, the following Assistants (BPS-16) are promoted to the post of Superintendent (BPS-16), Directorate General, Pakistan Post, Islamabad on regular/acting charge basis as mentioned against each with effect from

the date they actually assume the charge of the post of Superintendent (BPS-16):-

S. No.	Name of Officers	Remarks
1	Mr. Alam Zeb	Promoted to the post of Superintendent (BPS-16) on regular basis against clear vacancy.
2	Mr. Ahsan Waheed	-do-
3	Mr. Muhammad Nazir	-do-
4	Mr. Muhammad Shoaib Gul	-do-
5	Mr. Asghar Ayaz Memon	Promoted to the post of Superintendent (BPS-16) on acting charge basis against deputation leave vacancy, liable to be reverted to the post of Assistant on joining back of regular incumbent unless adjusted against a clear vacancy.
6	Mr. Mukhtar Ahmed	-do-
7	Mr. Muhammad Akhtar	-do-

2. The above named officers will be on probation for a period of one (01) year from the date they actually assume charge of the post of Superintendent (BPS-16). This period may be further extended by another one year, if considered necessary by the competent authority in terms of Rules 21 (1) (2) and (4) of the Civil Servants (Appointment, Promotion and Transfer) Rules, 1973.

No. CP. 5-10/2003-XVI.—On the recommendations of the Departmental Promotion Committee and with the approval of the competent authority viz Deputy Director General (Admn), Directorate General, Pakistan Post, Islamabad, the mentioned below Stenotypist (BPS-14) is promoted to the post of Assistant Private Secretary (BPS-16), Directorate General, Pakistan Post, Islamabad on acting charge basis with effect from the date he actually assumes the charge of the post of Assistant Private Secretary (BPS-16):-

S. No.	Name of Officer	Remarks
1	Mr. Muhammad Nasir Masood Khan	Promoted to the post of Assistant Private Secretary (BPS-16) on acting charge basis against LPR vacancy, liable to be reverted to the post of Stenotypist on joining back of regular incumbent unless adjusted against a clear vacancy.

2. The above named officers will be on probation for a period of one (01) year from the date they actually assume charge of the post of Assistant Private Secretary (BPS-16). This period may be further extended by another one year, if considered necessary by the competent authority in terms of Rules 21 (1) (2) and (4) of the Civil Servants (Appointment, Promotion and Transfer) Rules, 1973.

AHMAD ARBAB ABID,
Asstt. Deputy Director General (HR).

PAKISTAN PUBLIC WORKS DEPARTMENT

Islamabad, the 20th January, 2021

Islamabad, the 28th January, 2021

No. AI-717/700 (1652).—Consequent upon his transfer *vide* this office, office order of even number dated 6th January, 2021, Mr. Ghulam Hussain Shaikh, relinquished the charge to the post of Executive Engineer (QS), D.G's Office, Pak. PWD, Islamabad on 12th January, 2021.

Islamabad, the 1st February, 2021

No. AI-717/700 (1652).—Consequent upon his transfer *vide* this office, office order of even number dated 6th January, 2021, Mr. Ghulam Hussain Shaikh, assumed the charge to the post of Executive Engineer, Central Civil Division-VI, Pak. PWD, Karachi on 18th January, 2021.

Islamabad, the 2nd February, 2021

No. AI-717/700 (1252).—Pursuant to Ministry of Housing & Works Notification No. F. 2(9)/2016-Admn-III, dated 20th January, 2021 Mr. Muhammad Rashid, relinquished the charge to the post of Chief Engineer (C.Z), Pak, PWD, Lahore on 21st January, 2021 on current charge basis.

No. AI-717/700 (1224).—Consequent upon his transfer *vide* this office, office order of even number dated 21st January, 2021, Mr. Aurangzeb Ansari, assumed the charge to the post of Executive Engineer (QS), Central Civil Circle-II, Pak. PWD, Islamabad on 21st January, 2021.

M. B. KHATTAK,
Chief Administrative Officer.

PRESS INFORMATION DEPARTMENT

Islamabad, the 31st December, 2020

No. F-23(2830)/96-A.—With the approval of competent authority *i.e.* Director General/PIO Mr. Nadeem Akram, Assistant Administrative Officer, (BS-16) is granted 120 days leave on full pay with effect from 12th January, 2021 with permission to leave the station. The officer will join his duties after the expiry of leave at the same position and station.

SHAHID IMRAN RANJHA,
Deputy Director (Admin).

No. F-23(2805)/96-A.—Mr. Amir Shahzad, Assistant Information Officer (BS-16) Islamabad is granted 120 days leave on full pay from 1st September, 2020 to 29th December, 2020.

After availing 120-days leave on full pay, he has resumed duty on 30th December, 2020 on the same post and station.

IMRAN NASEER,
Information Officer (Admin).

SECRETARIAT TRAINING INSTITUTE

Islamabad, the 2nd February, 2021

No. F. 11-7/20120-Admn.—Mr. Faiz Akbar Faiz, Deputy Assistant Director (BS-16), Secretariat Training Institute, Islamabad, shall stand retired from Government Service, on attaining the age of superannuation with effect from 15th January, 2022.

2. In terms of Rule 18-A(1) of Revised Leave Rules, 1980, the option exercised by the above mentioned officer for encashment of L.P.R. on monthly basis, in lieu of 365 L.F.P. from 15th January, 2021 to 14th January, 2022, is hereby accepted.

This issues with the approval of Director General, STI, Islamabad.

NADEEM SIDDIQUI,
Deputy Director (Admn-I).

STAFF WELFARE ORGANIZATION

Islamabad, the 1st February, 2021

No. SWD-2(283)/87/Admn/429-33.—Mr. Muhammad Saeed, Chief Welfare Officer (BS-18), Staff Welfare Organization, Peshawar will stand retired from Government Service with effect from 11th December, 2021. According to this office record, his date of birth is 12th December, 1961.

No. SWD-2(195)/86/Admn/424-28.—Mr. Muhammad Soomer Chohan, Welfare Officer (BS-16), Staff Welfare Organization, Quetta will stand retired from Government Service with effect from 30th September, 2021. According to this office record, his date of birth is 1st October, 1961.

SABBAH MUSOOD,
Assistant Director (Admin).

The Gazette of Pakistan

PUBLISHED BY AUTHORITY

KARACHI, WEDNESDAY, APRIL 28, 2021

PART IV

Notifications issued by the minor administrations and miscellaneous notifications not included in any other part

MINISTRY OF INTERIOR

Members :

Islamabad, the 6th April, 2021

xi. Deputy Chief (Dev.), Ministry of Interior, Islamabad.

No. F. 6-10/2020/CDA-II(Mol).—The Competent Authority is pleased to constitute an 'Evaluation Committee' comprising the following to review all the components of Model Prison, Islamabad :-

xii. Consultant / Architect of the project, House No. 6, Street No. 6, F-6/3, Islamabad.

2. ToRs of the Committee will be as under :-

Chairperson :

i. Additional Secretary (Coord), Ministry of Interior, Islamabad.

i. Security Audit of Model Prison

Members :

ii. Chief Commissioner, ICT, Islamabad

ii. Ensuring protection of Women and Juvenile prisoners.

iii. Joint Secretary, Law & Justice Commission of Pakistan, Islamabad.

iii. Adoption of United Nations Standard Minimum Rules for the Treatment of Prisoners (the Nelson Mandela Rules).

iv. Director General, Pak PWD, Islamabad

iv. Farming of New Jail manual.

v. Chairman, Capital Development Authority, Islamabad.

SHAH JEHAN,
Deputy Secretary (CDA.MCI).

vi. Inspector General (Prisons), Government of Punjab, Lahore.

ISLAMABAD CAPITAL TERRITORY, CO-OPERATIVES
DEPARTMENT

vii. Inspector General of Police, Islamabad Capital Territory, Islamabad.

Islamabad, the 6th April, 2021

viii. Representative of Islamabad Bar Council, Islamabad.

No. 2080/CR/ICT/B.—In exercise of powers vested under section 54 of Cooperative Societies Act, 1925 read with Rule 33 of Cooperative Societies Rules, 1927, the Additional Deputy Commissioner (HQ), ICT, Islamabad is appointed as Registrar's nominee to decide the Case within 60 days titled as "Mr. Munir Ahmed Abbasi S/o. Muhammad Siddiqu Abbasi R/o. House No. 199, Main Double Road Sector I-14/3, Islamabad VS Jammu & Kashmir Cooperative Housing Society, Islamabad" in

ix. Representative of Ministry of Planning, Development & Special Initiatives, Islamabad.

x. Deputy Secretary (CDA/MCI), Ministry of Interior.

accordance with the requirements of Rules 33 of Islamabad Cooperative Societies Rules, 2018. The fee of the nominee is fixed as Rupees 20,000/- both the parties had to pay Rs. 10,000/- each. If the case is not decided within stipulated period the deposited fee shall be refunded to the both parties.

2. By orders of the Deputy Commissioner / Registrar Cooperative Societies, ICT, Islamabad.

No. 2083/CR/ICT/B.—In exercise of powers vested under section 54 of Cooperative Societies Act, 1925, read with Rule 33 of Cooperative Societies Rules, 1927, the Assistant Commissioner (City), ICT, Islamabad is appointed as Registrar's nominee to decide the Case within 60 days titled as "Mr. Ali Shan S/o. Muhammad Iqbal, Flat. No. 3, Block 92/B, G-9/2, Islamabad VS Federal Employees Cooperative Housing Society, Islamabad" in accordance with the requirements of Rules 33 of Islamabad Cooperative Societies Rules, 2018. The fee of the nominee is fixed as Rupees 20,000/- both the parties had to pay Rs. 10,000/- each. If the case is not decided within stipulated period the deposited fee shall be refunded to the both parties.

2. By orders of the Deputy Commissioner / Registrar Cooperative Societies, ICT, Islamabad.

No. 2084/CR/ICT/B.—In exercise of powers vested under section 54 of Cooperative Societies Act, 1925 read with Rule 33 of Cooperative Societies Rules, 1927, the Additional Deputy Commissioner (HQ), ICT, Islamabad is appointed as Registrar's nominee to decide the Case within 60 days titled as "Rana Adeel Ahmad S/o. Rana Muhammad Amjad R/o Gali Mudrasy Wali Muhala Mashn Compound Daska Distt. Attock VS Federal Employees Cooperative Housing Society, Islamabad" in accordance with the requirements of Rules 33 of Islamabad Cooperative Societies Rules, 2018. The fee of the nominee is fixed as Rupees 20,000/- both the parties had to pay Rs. 10,000/- each. If the case is not decided within stipulated period the deposited fee shall be refunded to the both parties.

2. By orders of the Deputy Commissioner / Registrar Cooperative Societies, ICT, Islamabad.

No. 2086/CR/ICT/B.—In exercise of powers vested under section 54 of Cooperative Societies Act, 1925 read with Rule 33 of Cooperative Societies Rules, 1927, the Additional Deputy Commissioner (HQ), ICT, Islamabad is appointed as Registrar's nominee to decide the Case within 60 days titled as "Syed Manzoor Hussain VS Civilian Employees Cooperative Housing Society, Islamabad" in accordance with the requirements of Rules 33 of Islamabad Cooperative Societies Rules, 2018. The fee of the nominee is fixed as Rupees 20,000/- both the parties had to pay Rs. 10,000/- each. If the case is not decided within stipulated period the deposited fee shall be refunded to the both parties.

2. By orders of the Deputy Commissioner / Registrar Cooperative Societies, ICT, Islamabad.

No. 2092/CR/ICT/B.—Consequent upon the elections of Managing Committee of Pakistani Professionals Cooperative Housing Society, Islamabad, the following members of the Society have been elected un-opposed for the period of three years in accordance with the Islamabad Capital Territory Cooperative Societies (Managing Committee Elections) Rules 2019, with immediate effect :

S. No.	Name of the Candidate / MS. No.	Post
1.	Syed Shahid Zulfiqar Ali / MS#OP-113	President
2.	Ms. Qaiser Sultana Ch. / MS#PP-235	Vice President
3.	Mr. Bashir Ud Din / MS#PP-2	Secretary
4.	Athar Ashraf Nizami / MS : PP-011	Treasurer
5.	Muhammad Hammad Bashir Saeed / MS:OP-115	Executive Member
6.	Farukh Ameen / MS:PP-07	Executive Member
7.	Mr. Aziz Ahmed Khan / MS#PP-201	Executive Member
8.	Muhammad Pervaiz Mirza / MS#OP-118/111	Executive Member

2. The newly elected Managing Committee is directed to take following actions immediately :-

- The Managing Committee will take over the charge of the Society immediately and act in accordance with the Cooperative Societies Act, 1925 and Islamabad Cooperative Societies Rules, 2018, as well as Byelaws of the Society and directions issued under Section 44-D & 44-E, dated 15th March, 2017.
- The Managing Committee of the Society should clear all issues pertaining to LOP / NOC from concerned Development Authority.

- iii. The Managing Committee is directed to pursue all the cases pending in different Courts on behalf of Society.
- iv. As per clause (2) of Gazette notification dated 3rd March, 2017 each member of a Managing Committee of Cooperative Society shall declare the details of assets in his name or in the name of his dependants as per enclosed performa within 30 days.
- v. The Managing Committee will submit its monthly progress report to the Registrar, Cooperative Societies, Islamabad.
3. This issues with the approval of Deputy Commissioner / Registrar Cooperative Societies, ICT, Islamabad.

MUHAMMAD MAZHAR ALI,
Circle Registrar,
Cooperative Societies Department.

The Gazette of Pakistan



PUBLISHED BY AUTHORITY

KARACHI, WEDNESDAY, APRIL 28, 2021

PART V

Notifications, etc., issued by The Patent Office

NEW APPLICATIONS FOR THE PATENTS

The dates shown in the crescent brackets are the dates claimed under section 86 of the Patents Ordinance, 2000.

7th September, 2020

577/2020 Nouman Idris Butt, Pakistan.—“SMART SURGICAL NEEDLE HOLDER”.

578/2020 COMPANIA INDUSTRIAL DE TABACOS MONTE PAZ S.A., and UNIVERSIDAD DE LA REPUBLICA, Uruguay (Priority 10th September, 2019, UY).—“FILTER MATERIAL AND FILTER TO RETAIN POLYAROMATIC HYDROCARBONS, CARBONYL AND OTHER SMOKE COMPOUNDS FROM TOBACCO PRODUCTS”.

579/2020 CASALE SA, Switzerland (Priority 24th September, 2019, EP).—“A METHOD FOR CONTROLLING A VIBRATING PRILLING BUCKET IN A UREA PRILLING PROCESS”.

580/2020 UPL LIMITED, India (Priority 10th September, 2019, IN).—“A STABLE LIQUID COMPOSITION”.

8th September, 2020

581/2020 RevoLaze, LLC, U.S.A (Priority 9th September, 2019, US).—“IMPROVED SCOURING PROCESS FOR RING DYED DENIM FABRIC AND MATERIAL PRODUCED THEREOF”.

9th September, 2020

582/2020 R.J. REYNOLDS TOBACCO COMPANY, U.S.A. (Priority 11th September, 2019, US).—“POUCHED PRODUCTS WITH ENHANCED FLAVOR STABILITY”.

583/2020 R.J. Reynolds Tobacco Company, U.S.A (Priority 11th September, 2019, US).—“ORAL PRODUCT WITH CELLULOSIC FLAVOR STABILIZER”.

584/2020 Advanced Accelerator Applications (Italy) Srl, Italy (Priority 17th September, 2019, EP).—“METHODS FOR RADIOLABELLING GRPR ANTAGONISTS AND THEIR KITS”.

10th September, 2020

585/2020 Wahab Hassan Butt, Pakistan.—“A COMPUTER-IMPLEMENTED REAL-TIME COMMUNICATION AND PARTICIPATION METHOD”.

586/2020 Muhammad Zaman & Farya Shabbir, Pakistan.—“Linseed-g-AAm hydrogel for enhanced solubility and sustained release of Tacrolimus”.

587/2020 Muhammad Zaman & Iqra Mubeen, Pakistan.—“DEVELOPMENT OF SEQUENTIAL RELEASE OF PITAVASTATIN AND EZETIMIBE IN THE FOR BILAYER TABLET”.

588/2020 BASF SE, Germany. (Priority 12th September, 2019, EP).—“REGULATORY NUCLEIC ACID MOLECULES FOR ENHANCING GENE EXPRESSION IN PLANTS”.

11th September, 2020

589/2020 National Agriculture Research Centre, Pakistan.—“Cradle for Laparoscopic Artificial Insemination in goats”

590/2020 Asghari Bano, Neelum Arooj and Asif Riaz, Pakistan.—“New method for the desalination of high TDS bearing water”.

APPLICATION ACCEPTED

Notice is hereby given that the person interested in opposing the grant of Patents to any of the applications referred to below at any time within four months from the date of this Patents' journal may give notice at the Patent Office on the prescribed Form P-7 of the Patents Rules 18(1) of 2003.

The six figures number shown in the right hand side are those given to applications on acceptance of the complete specification under which the specification will be printed and subsequent proceeding taken.

The figures shown within square brackets after the title of inventions indicate their classification index at acceptance.

Typed copies of the specification which are to open to public inspection can be supplied by the Patent Office on payment of the prescribed charges which may be ascertained on application to the office.

163/2009 Monsanto Technology LLC., U.S.A.—“METHOD AND COMPOSITION COMPRISING CORN PLANT EVENT MON87460”.

A01H1/04, C12N15/82 & C12Q1/68.

143596

The present invention relates to a corn chromosome comprising a first transgene/genomic junction polynucleotide of SEQ ID NO: 1 a heterologous transgenic insert of SEQ ID NO:7 comprising a truncated rice actin promoter that is operably linked to a cspB gene, and a second transgene/genomic junction polynucleotide of SEQ ID NO:2, wherein a 5' terminus of said insert overlaps a 3' terminus of SEQ ID NO: 1, and wherein a 3' terminus of said insert overlaps a 5' terminus of SEQ ID NO:2.

85/2013 Commercialbank Mattersburg im Burgenland Aktiengesellschaft, Austria.—“METHOD FOR BREAKDOWN OF TOXIC ORGANIC COMPOUNDS CONTAINED IN WASTE-WATERS AND/OR WASTE GASES”.

B01D53/78 & B01D53/70.

143597

Method for breakdown of toxic organic compounds contained wastewaters and/or waste gases, in which the wastewaters and/or waste gases (2) loaded with toxic organic compounds are first passed into an aqueous basic alkali/alkaline earth solution/suspension

bath (3) for destabilization of the toxic organic compounds and then the solution/suspension bath (3) containing the destabilized toxic organic compounds is fed in ascending fashion into a capillary mass (4) arranged above it, consisting of a mixture of pulps and peat mixed with bentonite, zeolite and/or lime with a particle size <200 µm.

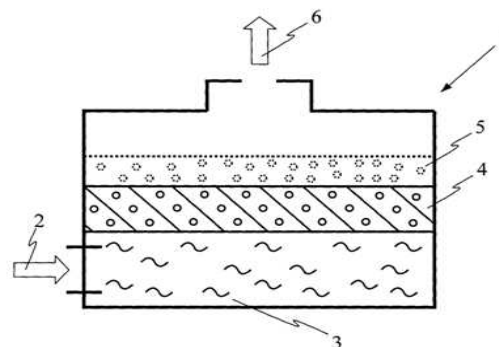

297/2017 CHIESI FARMACEUTICI S.p.A., Italy.—“NOVEL IMIDAZOLONE COMPOUND”.

C07D401/14, C07D403/14 & C07D403/04.

143598

This invention relates to imidazolone compound having neutrophil elastase inhibitory properties of compound of formula (I),

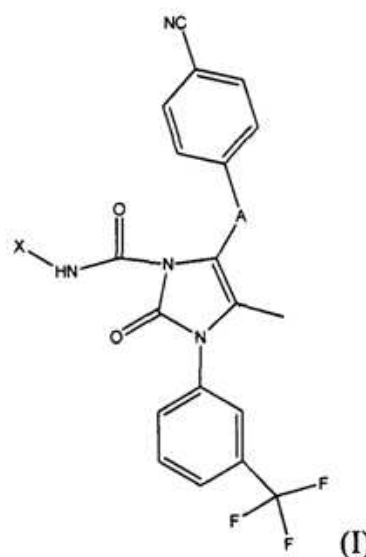

wherein

A is selected from the group consisting of

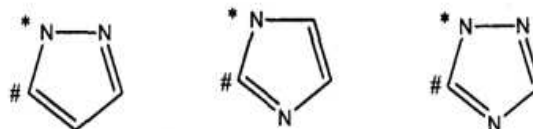

X is selected from the group consisting of

299/2017

CHIESI FARMACEUTICI S.p.A., Italy.—“NOVEL PYRAZOLONE COMPOUND”.

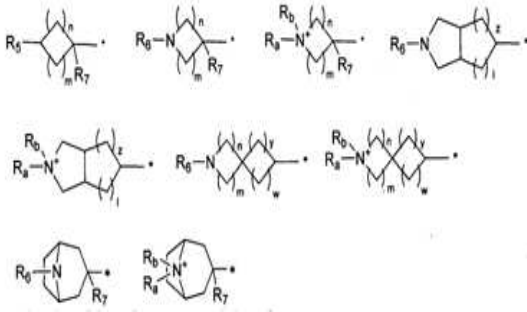

C07D403/14 & C07D401/14.

143600

This invention relates to compound of formula (I)

Or is selected from the group consisting of

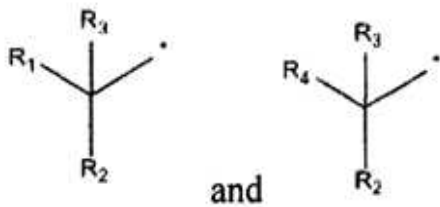

R₁, n, m, t, y, w, z, l, R₂, R₃, R₄, R₅, R₆, R_a, R_b, R_c, R_d, R_e, R₇, R₈, R₉, R₁₀ are as defined herein.

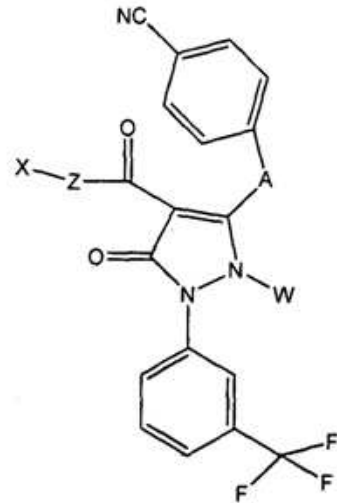

298/2017

CHIESI FARMACEUTICI S.p.A., Italy.—“NOVEL IMIDAZOLONE AND PYRAZOLONE COMPOUND”.

wherein

Z is —O- or —NH;

W is -H or (C1-C4)alkyl;

A is selected from the group consisting of

C07D231/22, C07D403/04 & C07D233/06.

143599

This invention relates to imidazolone and pyrazolone compound of formula (I)

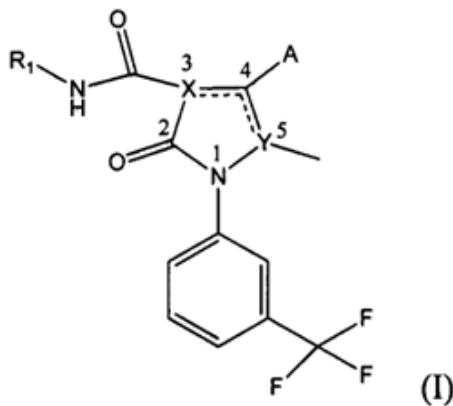
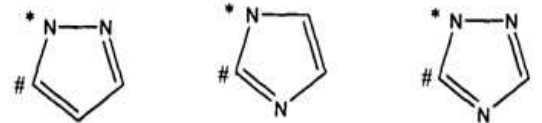

X, R₁, R₂, R₃, R₄, R₅, N, O, F and NC as defined herein;

The invention provides pyrazolone compound having neutrophil elastase inhibitory properties; and composition comprising compound of the invention.

727/2018

Sumitomo SHI FW Energia Oy., Finland.—“A boiler SYSTEM WITH A support construction”.

F22B37/00.

143601

wherein
 X is -C or-N;
 Y is C or N, wherein X and Y are not simultaneously C or N;
 R₁, A, R₂, R₃, R_a, R_b and R_c as defined herein;
 having neutrophil elastase inhibitory properties.

A boiler system (10), comprising a support construction (42) and a furnace (12) supported to the support construction at a vertically middle section of the furnace, the furnace being enclosed by water tube walls comprising two side walls (18) and two end walls (20), a roof (16) and a bottom (14), the side walls having a total height H from the bottom to the

roof, wherein each of the two side walls comprises a vertical upper portion (30) that extends from the roof to a level of 30-70 % of the height H, a lower portion (32) that extends from the bottom to a level of 30-70 % of the height H and has a vertical upper portion (36), and an in downward direction outwards bent intermediate portion (38) at a level between the upper portion of the side wall and the vertical upper portion of the lower portion of the side wall, wherein the support construction (42) comprises horizontal wall supporting beams (48) that are arranged parallel to the side walls (18) at a level below the roof (16) of the furnace and directly above the vertical upper portions (36) of the lower portions (32) of the two side walls (18), and the furnace (12) is supported to the support construction (42) by having the intermediate portions (38) of the side walls connected to adjacent horizontal wall supporting beams (48) so as to balance vertical loads of the furnace.

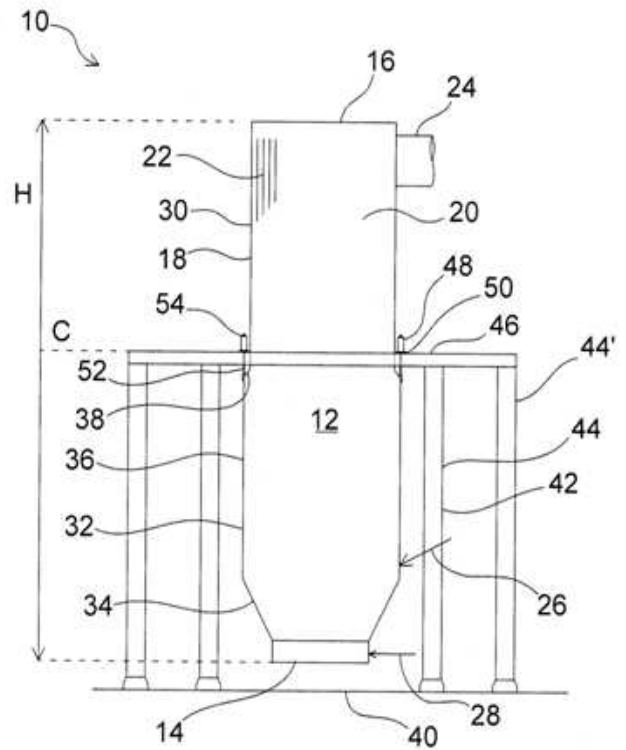

NEW APPLICATIONS FOR THE INDUSTRIAL DESIGNS

S. No.	Design No.	Title & Class	Applicant
7th September, 2020			
1.	20481	AEROSOL SPRAY FOR VEHICLES (CLASS-1)	MUHAMMAD SAEED NOOR, Karachi
2.	20482	LOCK DOWN HOLE FOR MOTORBIKE AND VEHICLES (CLASS-01)	Nazir Ahmad, Lahore
3.	20483	LOCK DOWN HOLE FOR MOTORBIKE AND VEHICLES (CLASS-1)	Nazir Ahmad, Lahore
4.	20484	MOBILE PHONE (CLASS-3)	VIVO MOBILE COMMUNICATION CO., LTD, CHINA
8th September, 2020			
5.	20485	BALL FOR SPORTS (Class-06)	MIKASA CORPORATION, JAPAN
9th September, 2020			
6.	20486	Car (Class-01)	CHERY AUTOMOBILE CO., LTD. CHINA

S. No.	Design No.	Title & Class	Applicant
11th September, 2020			
7.	20487	MP3 AUDIO PLAYER (BODY) (CLASS-1)	NADEEM SHAREEF, Multan
8.	20488	MP3 AUDIO PLAYER (BODY) (CLASS-1)	NADEEM SHAREEF, Multan
9.	20489	MP3 AUDIO PLAYER (BODY) (CLASS-1)	NADEEM SHAREEF, Multan
10.	20490	MP3 AUDIO PLAYER (BODY) (CLASS-1)	NADEEM SHAREEF, Multan
11.	20491	MP3 AUDIO PLAYER (BODY) (CLASS-1)	NADEEM SHAREEF, Multan
12.	20492	MP3 AUDIO PLAYER (BODY) (CLASS-1)	NADEEM SHAREEF, Multan
13.	20493	MP3 AUDIO PLAYER (BODY) (CLASS-1)	NADEEM SHAREEF, Multan
14.	20494	MP3 AUDIO PLAYER (BODY) (CLASS-1)	NADEEM SHAREEF, Multan

REGISTRATION OF DESIGNS

The following designs have been registered.

S. No.	Design No.	Title & Class	Applicant
7th September, 2020			
1.	20173	Divider (Class-03)	Sayyed Engineers Limited.
2.	20174	Compass (Class-03)	Sayyed Engineers Limited
3.	20225	Bottle (Class-03)	Syed Muhammad

S. No.	Design No.	Title & Class	Applicant
11th September, 2020			
4.	19532	KINETIC MONUMENTS (Class-12)	Muhammad Iqbal S/o. Ghulam Hussain
5.	19535	KINETIC MONUMENTS (Class-12)	Muhammad Iqbal S/o. Ghulam Hussain
6.	20115	ERASER (Class-03)	Abrar Ahmed, M/s. National Cottage Industries
7.	20116	ERASER (Class-03)	Abrar Ahmed, M/s. National Cottage Industries

DR. MUHAMMAD FAYYAZ AHMAD,
Controller of Patents & Registrar of Designs.

The Gazette of Pakistan

PUBLISHED BY AUTHORITY

KARACHI, WEDNESDAY, APRIL 28, 2021

PART VI

Advertisements and Notices issued by Corporate Bodies and
Private Individuals on payment

IN THE HIGH COURT OF SINDH AT KARACHI

(Companies Jurisdiction)

Judicial Company Misc. No. 02 of 2021

IN THE MATTER OF COMPANIES ACT, 2017

AND

HOME CATALOG SHOPPING (PRIVATE) LIMITED

Having its Registered Office situated at Office No. 725,
7th Floor, Regus Office, Executive Tower,
Dolmen City Mall, Clifton, Karachi.

HOME CATALOG SHOPPING
(PRIVATE) LIMITED,

A private limited company incorporated
under the laws of Pakistan having its
Registered Office situated at Office
No. 725, 7th Floor, Regus Office,
Executive Tower, Dolmen City Mall,
Clifton, Karachi.....Petitioner

NOTICE OF PETITION TO ALL CONCERNED:

Notice is hereby given that the above named
Petitioner has filed this Petition Under Section 301(a) &
304 of the Companies Act, 2017, Read with other
enabling provisions, praying :

- That the Petitioner company *i.e.* Home Catalog
(Private) Limited may be wound up by the Court
under the provisions of the Companies Act, 2017
and an Official Liquidator appointed; and
- Such other order may be made as shall be just.

The petition was presented on 4th February, 2021
by the above named Petitioner through their
counsel M/s. Mohsin Tayebaly & Co., Advocates,
the said petition is fixed in Court before :
Deputy Registrar (Original Side) on 16th March,
2021 at 10:00 A.M.

Any person desirous of supporting or opposing the
making of an order as prayed in the Petition should appear
at the time of hearing by himself or by his advocate. A Copy
of the petition will be furnished to any person requiring the
same on application and payment of usual fees for copies of
such documents.

Given under my hand and Seal of the Court this 19th day
of February, 2021.



By Order

Sd/-

Assistant Registrar
Execution & Misc. Branch.

IN THE HIGH COURT OF SINDH AT KARACHI

(Companies Jurisdiction)

Judicial Company Misc. No. 03 of 2021

In the matter of :

Sections 279 to 283 and 285(8) of the Companies
Act, 2017

- ASSOCIATED CONSULTING
ENGINEERS ACE LIMITED**, a public
company limited by shares, incorporated
under the provisions of the companies
Act, VII of 1913, and existing under
the provisions of the Companies Act,
2017, having its Registered Office at
C-46, KDA Scheme No. 1, Karachi.

2. ACE ARCHITECTURAL & TOWN PLANNING SERVICES LIMITED, a public company limited by shares, incorporated and existing Under the provisions of the Companies Act, 2017, having its Registered Office at C-46, KDA Scheme # 1, Karsaz, Gulshan Town, Karachi.Petitioners

Notice is hereby given that the above named petitioner has filed this Petition under Section 279 Read with Sections 280 to 283 and 285(8) of the Companies Act, 2017, praying that this Hon'ble Court may be pleased to pass the following orders, if the required majority of shareholders and secured creditors (to the extent applicable) of the Petitioners No. 1 and 2 have approved the Scheme of Arrangement at meetings called by orders of this Hon'ble Court on the Petitioners' application made under Rule 55 of the Companies Court Rules, 1997 :

(a) make an order under Section 279(2) of the Companies Act, 2017 sanctioning the Scheme of Arrangement as *set forth* in Annexure "C" hereto so as to make the Scheme of Arrangement binding on the Petitioners and the creditors (as applicable) and shareholders of the Petitioners No. 1 and 2, along with all other persons.

(b) make the following orders under Section 282 of the Companies Act, 2017 namely :

(i) An order under Section 282(3) of the Companies Act, 2017, transferring to and vesting in the Petitioner No. 2 the specific portions of the undertaking of the Petitioner No. 1, *i.e.* the Demerged Undertaking, including all assets, properties, liabilities, rights, benefits, powers, privileges, contracts, licences, permits, authorizations and obligations with respect thereto, as more particularly described in the Scheme of Arrangement as *set forth* in Annexure "C" hereto.

(ii) All necessary orders to give effect to the Scheme of Arrangement, including but not limited to, orders whereby all assets, business, undertaking, properties, rights, licences, permits, authorizations, obligations and liabilities of the Petitioner No. 1, to the extent of the Demerged Undertaking (as defined in the Scheme of Arrangement), are transferred to and stand vested in the Petitioner No. 2, with effect from the Effective Date as defined under the Scheme of Arrangement, being the start of business on 1st July, 2020, or such date as may be specified by this Hon'ble Court.

(iii) An order under Section 282(3)(c) of the Companies Act, 2017 directing that all suits, appeals, arbitration, governmental investigations and other legal proceedings instituted by or against the Petitioner No. 1, with respect to the Demerged Undertaking, and any judgments, orders or directions passed in respect of the Petitioner No. 1, with respect to the Demerged Undertaking, shall be treated as suits, appeals and legal proceedings by or against the Petitioner No. 2, and judgments, orders or directions passed in respect of the Petitioner No. 1 (to the extent of the Demerged Undertaking), may be continued, prosecuted and enforced by or against the Petitioner No. 2 accordingly.

(iv) An order that all books of accounts and other documents which would before the Effective Date have been the evidence in respect of any matter for or against the Petitioner No. 1, shall be admissible in evidence in respect of the same matter for and against Petitioner No. 2, to the extent of the Demerged Undertaking of the Petitioner No. 1 being merged with and into the Petitioner No. 2.

(c) make such further order(s) as this Hon'ble Court may deem fit.

The petition was presented on 8th February, 2021 by the above named Petitioner through their counsel M/s. Mohsin Tayebaly & Co., Advocates, the said Petition is fixed in Court before : Deputy Registrar (Original Side) on 16th March, 2021 at 10:00 A.M.

Any person desirous of supporting or opposing the making of an Order as prayed in the Petition should appear at the time of hearing by himself or by his advocate, A copy of petition will be furnished to any person requiring the same on application and payment of usual fees for copies of such document.

Given under my hand and Seal of the Court this 18th day of February, 2021.



By Order

Sd/-

Assistant Registrar
Execution & Misc. Branch.

