



The Gazette of Pakistan

PUBLISHED BY AUTHORITY

No. 15]

KARACHI, WEDNESDAY, APRIL 14, 2021

CONTENTS

	PAGES		PAGES
PART I — Notifications regarding appointments, promotions, etc., issued by Ministries/Divisions of the Government of Pakistan, Department of the Auditor-General of Pakistan and the Supreme Court of Pakistan other than the Ministry of Defence and Ministry of Defence Production	403—430	PART IV — Notifications issued by the minor administrations and miscellaneous notification not included in any other part	33—34
PART II — Notifications issued by the Ministry of Defence and Ministry of Defence Production	101—106	PART V — Notifications etc., issued by The Patent Office.	101—108
PART III — Notifications issued by the High Courts, the Federal Public Service Commission and by the Attached and Subordinate Offices of the Government of Pakistan	221—232	PART VI — Advertisements and Notices issued by Corporate Bodies and Private Individuals on payment	25—xx
		SUPPLEMENT NO.	
		Weekly, notification of cases and deaths from quarantiable diseases	

PART I

Notifications regarding appointments, promotions, etc. issued by Ministries/Divisions of the Government of Pakistan, Department of the Auditor-General of Pakistan and the Supreme Court of Pakistan other than the Ministry of Defence and Ministry of Defence Production

PRIME MINISTER'S OFFICE (PUBLIC)

Islamabad, the 9th March, 2021

No. F. 3(2)/2020-Admn.—In pursuance of Establishment Division's Notification No. F. 1/2/2020-E-5(PAS), dated 26th February, 2021, Mr. Muhammad Haroon-ur-Rafique, a BS-20 officer of Pakistan Administrative Service on his promotion to BS-21, has relinquished the charge of the post of Joint Secretary (BS-20) in the Prime Minister's Office (Public), with effect from 1st March, 2021.

HAIDER MUNAWAR CHEEMA,
Section Officer (Admn).

[BOARD OF INVESTMENT]

Islamabad, the 8th March, 2021

No. 1(2)-HR/2021.—Mr. Zulfiqar Ali, Director (Policy and Planning) (BS-19) Board of Investment, Islamabad is

allowed to hold the additional charge of the post of Director (Legal/BS-19) with immediate effect for a period of three months or till the joining of regular incumbent, whichever is earlier.

In terms of Finance Division's O. M. No. 1(2)Imp/ 2016-333 dated 1st July, 2016, the officer is eligible to draw special pay @ 20% of the basic pay subject to not exceeding Rs. 12,000/- per month.

No. 1(2)-HR/2021.—Mr. Shahzad Ahmed, Deputy Assistant Director (BS-16), Board of Investment, Islamabad is allowed to hold the current charge of the post of Assistant Director (BS-17) with immediate effect for a period of three months or till the joining of regular incumbent, whichever is earlier.

In terms of Finance Division's O. M. No. 1(2)Imp/2016-333 dated 1st July, 2016, the officer is eligible to draw special pay @ 20% of the basic pay subject to not exceeding Rs. 12,000/- per month.

No. 1(2)-HR/2021.—Mr. Atif Noor Khan, Deputy Assistant Director (BS-16), Board of Investment, Islamabad is allowed to hold the current charge of the post of Assistant Director (BS-17) with immediate effect for a period of three months or till the joining of regular incumbent, whichever is earlier.

In terms of Finance Division's O. M. No. 1(2)Imp/2016-333 dated 1st July, 2016, the officer is eligible to draw special pay @ 20% of the basic pay subject to not exceeding Rs. 12,000/- per month.

ABDUL SATTAR,
Deputy Director (HR).

[ADMINISTRATION WING]

Karachi, the 8th March, 2021

No. E-II/30(2850)/BOI/2021.—After availing 40 days leave on full pay with effect from 11th January, 2021 to 19th February, 2021 which was granted *vide* this office's notification of even number dated 8th January, 2021, Mr. Suhrab Khan, Assistant Private Secretary (BPS-16) of this office has resumed his duties on 22nd February, 2021 (20th & 21st February, 2021) being public holidays on the same post and station.

AFTAB AHMED,
Director.

NATIONAL ACCOUNTABILITY BUREAU

Islamabad, the 18th February, 2021

No. 3(2022)/HQ/2021/PM-I.—In pursuance of Office of the Controller of Military Accounts, Rawalpindi, Letter No. G/ AN-I/1694/RC/36673 dated 11th February, 2021, Competent Authority has been pleased to approve appointment of Mr. Gulzar Hussain, Computer Operator, office of the Controller of Military Accounts against a vacant post of Assistant Private Secretary (BPS-16), National Accountability Bureau (HQ), Islamabad for an initial period of three years on deputation basis with effect from 11th February, 2021, on standard terms & conditions.

IMRAN SOHAIL,
Additional Director (PM).

Islamabad, the 19th February, 2021

No. 7-7(204)/P/2006/Admn-I/L.—The Competent Authority has been pleased to grant 60 days leave in respect of Mr. Asif Waheed, Deputy Director (BS-18) NAB (Lahore) with effect from 8th January, 2021 to 8th March, 2021

on medical grounds as admissible under Revised Leave Rules, 1980.

On the expiry of leave, the officer shall resume his duties at the same post and station.

MUHAMMAD ZEESHAN HAIDER,
Deputy Director (PM-V).

Islamabad, the 18th February, 2021

No. 7-4(60)-Admn-II/2000.—Consequent upon superannuation of Mr. Nadeem Aslam, Data Control Supervisor (BPS-16), DG (HRM) is pleased to approve his retirement from Government Service on attaining the age of superannuation on 1st February, 2022 under Section 8.05 of NAB Employees Terms & Conditions of Service (TCS) 2002.

No. 7-4(60)-Admn-II/2000.—Consequent upon superannuation DG (HRM) is pleased to grant encashment of 365 days leave on full pay in lieu of leave preparatory to retirement (LPR) as per rules to Mr. Nadeem Aslam, Data Control Supervisor (BPS-16), NAB (KP) Peshawar.

LUBNA BASHIR,
Assistant Director (PM-II).

Islamabad, the 18th February, 2021

No. 7-7(4)/Inquiry/K/2020-PM-III.—In continuation of this Bureau's notification of even number dated 10th August, 2020 & 17th November, 2020 and in terms of Section 11.04 of NAB Employee's Terms & Conditions of Services (TCS) (2002), the suspension period of Mr. Asif Amanat, Assistant Director (BPS-17), NAB (Karachi) stands further extended for a period of three months with effect from 10th February, 2021.

No. 3(1819)/B/2017/PM-III.—In pursuance of NAB HQ notification of even number dated 14th January, 2021, Mr. Ghazanfar Hussain Siddiqui, Assistant Accounts Officer (BPS-17), an officer of office of the Accountant General Balochistan Quetta, has relinquished the charge of the post of Assistant Director (BPS-17) NAB (Balochistan), Quetta, with effect from 4th February, 2021.

Islamabad, the 19th February, 2021

No. 3(1341)/S/2013-PM-III.—In continuation of this Bureau's notification of even number dated 3rd September, 2020 & 14th December, 2020 and in terms of Section 11.04 of NAB Employee's Terms & Conditions of Services (TCS) (2002), the suspension period of Mr. Muhammad Umair, Assistant Director (BPS-17), NAB (Karachi) stands further extended for a period of two months with effect from 3rd February, 2021.

No. 10-1(51)/27/CI&MT/NAB/HQ2020/535.—In pursuance of this Bureau's notification of even number dated 5th August, 2019, Mr. Saqib Siddique, has relinquished the charge of the post of Assistant Director (BPS-17) NAB (Balochistan), Quetta with effect from 22nd January, 2021 and assumed the charge of the post of Assistant Director (BPS-17) NAB (Karachi), with effect from 3rd February, 2021.

HAMZA NIHAL TARIQ,
Assistant Director (PM-III).

Islamabad, the 18th February, 2021

No. 1(714)/Admn/2016/3286.—Director General NAB (R) / Islamabad has been pleased to grant 29 days leave on full pay (LFP) with effect from 22nd February, 2021 to 22nd March, 2021 in respect of Mr. Aqeel Zafar, Assistant Director (BPS-17), NAB Rawalpindi/Islamabad.

On the expiry of leave, the officer will resume his duty of the same post at the same station.

No. 1(538)/Admn/2013/3287.—Director General NAB (R) / Islamabad has been pleased to grant 19 days leave on full pay (LFP) on medical grounds with effect from 1st February, 2021 to 19th February, 2021 in respect of Mr. Azmat Ullah, Assistant Director (BPS-17), NAB (R), Sub Office Gilgit.

On the expiry of leave, the officer will resume his duties of the same post at the same station.

MUHAMMAD QASIM,
Assistant Director (Admn).

CABINET SECRETARIAT

(Cabinet Division)

Islamabad, the 28th January, 2021

No. PF. (3241)-Admn-I.—Mr. Kanwar Wajahat Ali, Assistant Private Secretary, Cabinet Division has been granted 17 days LFP with effect from 13th January, 2021 to 29th January, 2021, under the Revised Leave Rules, 1980.

After expiry of above leave, the officer will resume his duty at the same post and station.

ASIF MAHMOOD,
Section Officer (Admn-I).

Islamabad, the 9th February, 2021

No. PF. (739)-Admn-II.—In pursuance of Establishment Division's Notification No.1-53/2020-E-II, dated 30th December, 2020, Mr. Muhammad Ashfaq, Deputy Secretary (BS-19)

Cabinet Division, stands retired from Government Service on attaining the age of superannuation on 31st December, 2020.

The competent authority, has also been pleased to approve grant of Leave Encashment of 365 days to the officer in lieu of whole period of L.P.R due and admissible in terms of Rule 18-A (1) of Revised Leave Rules, 1980, as amended.

No. PF.(1093)-Admn-II.—With the approval of Additional Secretary-III, Ms. Saima Ashraf, Deputy Secretary (Dev-I) (BS-19), Cabinet Division has been granted fifteen (15) days leave on full pay (LFP) on medical grounds from 1st February, 2021 to 15th February, 2021, under the Revised Leave Rules 1980, subject to title.

On the expiry of leave, the officer is likely to resume her duties on the same post at the same station.

No. PF.(1129)-Admn-II.—In pursuance of Establishment Division's Notification No.PF.1111/2011-E-VII dated 8th February, 2021, Mr. Najeeb Ullah Khan, Section Officer (OMG/BS-18), Institutional Reforms Cell, under Cabinet Division has relinquished the charge of the said post with effect from 1st February, 2021.

No. PF.(1159)-Admn-II.—With the approval of Additional Secretary-III, Ms. Fazelat Naeem, Section Officer (Implementation) (BS-18), Cabinet Division has been granted twenty five (25) days leave on full pay (LFP) from 2nd February, 2021 to 26th February, 2021, under the Revised Leave Rules 1980, subject to title.

On the expiry of leave, the officer is likely to resume her duties on the same post and station.

SYED ZAWAD HAIDER,
Section Officer (Admn-II).

(Aviation Division)

Islamabad, the 7th January, 2021

No. F. 1-11/2020-Admin.—Mr. Muhammad Namaan Mustafa, Section Officer (Admin) has been granted Additional Charge of the post of Section Officer (General) for a period of three (03) months with effect from 4th January, 2021 or till the posting of a regular Section Officer whichever is earlier.

This issues with the approval of Secretary Aviation Division.

SHEIKH NOOR MUHAMMAD,
Deputy Secretary (Admin).

Islamabad, the 7th January, 2021

No. 1/9/2018/Met.—In pursuance of Aviation Division's notification of even number dated 5th October, 2020, following officers of Pakistan Meteorological Department have assumed the charge of the posts on the dates as mentioned against each:-

Sr. No.	Names/Designation M/s	Charge assume of the post	Date of Joining	Place of posting on promotion
1.	Munazza Hameed	Sr. Electronic Engineer (BS-18)	06-10-2020	Flood Forecasting Division (FFD), Lahore.
2.	Jia Kumar	Sr. Electronic Engineer (BS-18)	23-11-2020	Flood Forecasting Division (FFD), Lahore.
3.	Syed Waseem Haider	Electronic Engineer (BS-17)	10-07-2020	PMD, Headquarters Camp Office Karachi
4.	Kamal Ahmed	Electronic Engineer (BS-17)	10-07-2020	Regional Met. Centre (RMC), Karachi
5.	Muhammad Anwar	Electronic Engineer (BS-17)	10-09-2020	Flood Forecasting Division (FFD), Lahore
6.	Muhammad Munir	Electronic Engineer (BS-17)	29-10-2020	Flood Forecasting Division (FFD), Lahore
7.	Shahid Mehmood	Meteorologist (BS-17)	06-11-2020	Flood Forecasting Division (FFD), Lahore
8.	Manzoor Hussain	Meteorologist (BS-17)	09-11-2020	Regional Met. Centre (RMC), Lahore
9.	Naeem-UI-Haq	Meteorologist (BS-17)	03-08-2020	DMO, PMD, Hyderabad

2. The officers will be on probation for a period of one year and if no order is issued on expiry of probation period, it shall deem to have been extended for a period not exceeding one year.

Islamabad, the 11th January, 2021

No. 1/6/2013/Met.—Dr. Muhammad Hanif, Chief Meteorologist (BS-20), R&D, Pakistan Meteorological Department, Islamabad shall stand retired from Government Service with effect from 26th April, 2021 on attaining the age of superannuation.

SEHRISH MAZARI,
Section Officer.

(Establishment Division)

Islamabad, the 1st February, 2021

No. F. 40/581/2014-E-1.—Mrs. Samina A Hasan, a BS-21 officer of Secretariat Group, presently posted as Senior Joint Secretary, Cabinet Division, is transferred and posted as Additional Secretary, Revenue Division, with immediate effect and until further orders.

Islamabad, the 2nd February, 2021

No. F. 3-24/2020-E-2.—Mr. Zulfiqar Ali Samin, Assistant Chief (Dev.) (BS-18), Interior Division, is transferred and posted as Deputy Secretary (BPS-19), Federal Education

No. 3-18/2020-E-2.—Mr. Muhammad Khalid, a BS-18 officer of Office Management Group, presently Officer on Special Duty (OSD), Establishment Division is transferred and his services are placed at the disposal of Railways Division, for onward posting as Director, under Section-10 of Civil Servants Act, 1973, with immediate effect and until further orders.

Islamabad, the 17th February, 2021

No. F.11/16/2017-E-1.—The transfers/ postings of the following officers of Office of Auditor General of Pakistan with immediate effect and until further orders:-

S. No.	Name of Officers (M/S)	From	To	Look-after charge
1.	Izzat Jahan (BS-20/PA&AS)	Awaiting posting at AGP Office, Islamabad/ on NS & War Course 2020-2021	Chief Finance & Accounts Officer, Overseas Pakistanis & Human Resource Development Division, Islamabad	Assigned Look-after charge of the post of Chief Finance & Accounts Officer, Industries & Production Division, Islamabad
2.	Asif Hameed (BS-20/PA&AS)	Chief Finance & Accounts Officer, Overseas Pakistanis & Human Resource Development Division, Islamabad	Director (Finance), PNRA, Islamabad	--
3.	Ghulam Mustafa Somon (BS-20/PA&AS)	Chief Finance & Accounts Officer, Maritime Affairs Division, Islamabad	Director (Finance), SUPRACO, Karachi	--

and Professional Training Division, under Section 10 of Civil Servants Act, 1973 with immediate effect and until further orders.

Islamabad, the 3rd February, 2021

CORRIGENDUM

No. F. 8/3/2020-E-I.—The words “PA-29136 Major General Ghulam Jafar” written in the first line of this Division’s notification of even number dated 18th December, 2020 be read as “PA-29163 Major General Ghulam Jaffar”.

Islamabad, the 4th February, 2021

No. F. 3-19/2011-E-2.—Mr. Khalid Rasool, a BS-19 officer of the Commerce and Trade (C&T) Group, presently posted as Deputy Secretary, Interior Division, is repatriated to his parent department *i.e.* Commerce Division, with immediate effect and until further orders.

Islamabad, the 12th February, 2021

No. 1-6/2019-E-2.—Syed Farrukh Mehboob, a BS-19 officer of Secretariat Group, presently posted as Deputy Secretary, Economic Affairs Division, is transferred and posted as Director (BS-19), President’s Secretariat (Public), on deputation basis for a period of three (03) years, on standard terms and conditions, with immediate effect and until further orders.

No. 1-32/2013-E-2.—Mr. Saifullah Janbaz, a BS-19 Officer of the Secretariat Group, presently posted as Deputy Secretary, National Food Security & Research Division, is transferred and posted as Deputy Secretary, Interior Division, with immediate effect and until further orders.

No. 1-14/2017-E-2.—Mr. Tariq Aleem Gill, a BS-19 Officer of the Secretariat Group, presently posted as Deputy Secretary, Interior Division, is transferred and posted as Deputy Secretary, National Food Security & Research Division, with immediate effect and until further orders.

No. F.40/561/2013-E-1.—The Additional charge of the post of Secretary, Law and Justice Division, assigned to Raja Naeem Akbar, Senior Consultant (MP-I), Law and Justice Division, is extended with effect from 8th February, 2021, for a period of three (03) months or till posting of a regular incumbent, whichever is earlier.

OBITUARY

No. 1-81/2008-E-2.—The Government of Pakistan announces with deep regret the sad demise of Mr. Abdul Razzak Mughal, a BS-19 officer of Secretariat Group who expired on 20th January, 2021.

2. Mr. Abdul Razzak Mughal was born on 24th September, 1961. He first joined service under the Federal Government on 30th May, 1988 and subsequently after his appointment in OMG on 17th November, 1999, served in various capacities in the Federal Secretariat. At the time of his death on 20th January, 2021, the officer was serving as Deputy Secretary, Industries and Production Division, Islamabad, Mr. Abdul Razzak Mughal was a conscientious, hard working and dedicated officer who held important assignments and exhibited commendable devotion to duty. His death has deprived the Government of Pakistan of an able and competent officer.

3. The Government of Pakistan wishes to place on record its appreciation of the dedicated services rendered by the deceased.

4. In expressing its deep sense of grief at the sudden demise of Mr. Abdul Razzak Mughal the Government of Pakistan conveys its condolence and sympathy to the members of the bereaved family. May his soul rest in peace. Aameen.

Islamabad, the 23rd February, 2021

No. F.50/1/2011-E-I.—The contract appointment of Mr. Muhammad Rafique Tahir, as Joint Educational Advisor (BS-20), head of National Curriculum Council (NCC) Project, under Ministry of Federal Education & Professional

training, is extended for a period of one (01) year, with effect from 6th July, 2020, in term of Finance Division's O.M. No. F. 4(9) R-14/2008 dated 19th July, 2017.

Islamabad, the 25th February, 2021

No. F.1-18/2012-E-2.—Mr. Abdul Latif (SG/BS-19), presently posted in Benazir Income Support Programme (BISP), on deputation basis, is transferred and posted as Deputy Secretary, Human Resource Management Policy Reforms Cell (HRMPCR), M. S. Wing Establishment Division, with effect from 21st March, 2021.

Islamabad, the 26th February, 2021

No. F.41/481/2017-E-I.—Mr. Pervaiz Ahmed Junejo, a BS-22 officer of Secretariat Group, presently posted as Executive Director, National Institute of Population Studies (NIPS), under National Health Services, Regulations & Coordination Division, is transferred and posted as Secretary, States & Frontier Regions (SAFRON) Division, with immediate effect and until further orders.

No. F.40/620/2019-E-I.—Mr. Abdul Sattar Khokhar, a BS-21 officer of Secretariat Group, presently posted as Senior Joint Secretary, Aviation Division, is transferred and posted as Additional Secretary, Cabinet Division, with immediate effect and until further orders.

No. F.40/592/2017-E-I.—Mr. Owais Nauman Kundi, a BS-21 officer of Secretariat Group, presently posted as Senior Joint Secretary, Economic Affairs Division, is transferred and posted as Additional Secretary, Law & Justice Division, with immediate effect and until further orders.

No. F.40/597/2017-E-I.—Mr. Muhammad Shakeel Malik, a BS-21 officer of Secretariat Group, presently posted as Additional Secretary, Parliamentary Affairs Division, is assigned look after charge of the post of Secretary, Parliamentary Affairs Division, in addition to his own duties, with immediate effect and until further orders.

No. F.40/633/2021-E-I.—Mr. Iftikhar-UI-Hassan Shah Gilani, a BS-20 officer of Secretariat Group, presently posted as Joint Secretary, Planning Development & Special Initiatives Division, is promoted to BS-21 in that Group, on regular basis, with immediate effect.

On promotion, Mr. Iftikhar-UI-Hassan Shah Gilani, is posted as Senior Joint Secretary, Planning Development & Special Initiatives Division, until further orders.

No. F.40/634/2021-E-I.—Dr. Muhammad Tariq Moj, a BS-20 officer of Secretariat Group, presently at the disposal of National School of Public Policy (NSPP), Lahore, under Section 10 of Civil Servants Act, 1973, is promoted to BS-21 in that Group, on regular basis, with immediate effect.

On promotion, Dr. Muhammad Tariq Moj, shall remain at the disposal of NSPP, Lahore under Section 10 of Civil Servants Act, 1973, until further orders.

No. F.40/635/2021-E-I.—Syed Moazzam Ali, a BS-20 officer of Secretariat Group, presently posted as Joint Secretary, Prime Minister's Office (Public), Islamabad on deputation basis, is promoted to BS-21 in that Group, on regular basis, with immediate effect.

On promotion, Syed Moazzam Ali, is posted as Senior Joint Secretary, Prime Minister's Office (Public), until further orders.

No. F.40/636/2021-E-I.—Mr. Taimur Tajamal, a BS-20 officer of Secretariat Group, presently posted as Joint Secretary, Cabinet Division, is promoted to BS-21 in that Group, on regular basis, with immediate effect.

On promotion, Mr. Taimur Tajamal, is posted as Senior Joint Secretary, Cabinet Division, until further orders.

No. F.40/637/2021-E-I.—Dr. Asmat Nawaz, a BS-20 officer of Secretariat Group, presently at the disposal of President's Secretariat (Public), as Director General (BS-20), is promoted to BS-21 in that Group, on regular basis, with immediate effect.

On promotion, Dr. Asmat Nawaz, is transferred and posted as Senior Joint Secretary, Commerce Division, until further orders.

No. F.40/638/2021-E-I.—Mr. Hassan Naqvi, a BS-20 Officer of Secretariat Group, presently posted as Joint Secretary, Aviation Division, is promoted to BS-21 in that Group, on regular basis, with immediate effect.

On promotion, Mr. Hassan Naqvi, is posted as Senior Joint Secretary, Aviation Division, until further orders.

No. F.40/639/2021-E-I.—Mr. Qumar Sarwar Abbasi, a BS-20 officer of Secretariat Group, presently posted as Joint Secretary, Planning Development & Special Initiatives Division, is promoted to BS-21 in that Group, on regular basis, with immediate effect.

On promotion, Mr. Qumar Sarwar Abbasi, is posted as Senior Joint Secretary, Planning Development & Special Initiatives Division, until further orders.

No. F.40/640/2021-E-I.—Mr. Saad Fazil Abbasi, a BS-20 Officer of Secretariat Group, presently posted as Joint Secretary, Finance Division, is promoted to BS-21 in that Group, on regular basis, with immediate effect.

On promotion, Mr. Saad Fazil Abbasi, is posted as Senior Joint Secretary, Finance Division, until further orders.

No. F.40/641/2021-E-I.—Mr. Alam Zeb Khan, a BS-20 officer of Secretariat Group, presently posted as Administrator (BS-20), Abandoned Properties Organization (APO), under Cabinet Division, under Section 10 of Civil Servants Act, 1973, is promoted to BS-21 in that Group, on regular basis, with immediate effect.

On promotion, Mr. Alam Zeb Khan, is transferred and posted as Senior Joint Secretary, Power Division, until further orders.

No. F.40/642/2021-E-I.—Mr. Muhammad Ashfaq Ghumman, a BS-20 officer of Secretariat Group, presently posted as Joint Secretary, Planning Development & Special Initiatives Division, is promoted to BS-21 in that Group, on regular basis, with immediate effect.

On promotion, Mr. Muhammad Ashfaq Ghumman, is posted as Senior Joint Secretary, Planning Development & Special Initiatives Division, until further orders.

No. F.40/643/2021-E-I.—Mr. Sajid Mahmood Qazi, a BS-20 officer of Secretariat Group, presently posted as Joint Secretary, Petroleum Division, is promoted to BS-21 in that Group, on regular basis, with immediate effect.

On promotion, Mr. Sajid Mahmood Qazi, is posted as Senior Joint Secretary, Petroleum Division, until further orders.

No. F.40/645/2021-E-I.—Syed Mujtaba Hussain, a BS-20 officer of Secretariat Group, presently posted as Joint Secretary, Climate Change Division, is promoted to BS-21 in that Group, on regular basis, with immediate effect.

On promotion, Syed Mujtaba Hussain, is posted as Senior Joint Secretary, Climate Change Division, until further orders.

No. F.40/626/2021-E-I.—Mr. Jamil Anwar, a BS-20 officer of Secretariat Group, presently posted as Joint Secretary, Defence Production Division, is promoted to BS-21 in that Group, on regular basis, with immediate effect.

On promotion, Mr. Jamil Anwar, is posted as Senior Joint Secretary, Defence Production Division, until further orders.

No. F.40/627/2021-E-I.—Ms. Aisha Humera Chaudhary, a BS-20 officer of Secretariat Group, presently posted as Joint Secretary, Commerce Division, is promoted to BS-21 in that Group, on regular basis, with immediate effect.

On promotion, Ms. Aisha Humera Chaudhary, is posted as Senior Joint Secretary, Commerce Division, until further orders.

No. F.40/644/2021-E-I.—Mr. Rizwan Ahmed Sheikh, a BS-20 Officer of Secretariat Group, presently posted as Joint Secretary, Finance Division, is promoted to BS-21 in that Group, on regular basis, with immediate effect.

On promotion, Mr. Rizwan Ahmed Sheikh, is posted as Senior Joint Secretary, Finance Division, until further orders.

No. F.40/628/2021-E-I.—Mr. Alamgir Ahmed Khan, a BS-20 Officer of Secretariat Group, presently at the disposal of Government of Punjab, is promoted to BS-21 in that Group, on regular basis, with immediate effect.

On promotion, Mr. Alamgir Ahmed Khan, is transferred and posted as Senior Joint Secretary, Religious Affairs and Interfaith Harmony Division, until further orders.

No. F.40/629/2021-E-I.—Mr. Muhammad Khurshid, a BS-20 Officer of Secretariat Group, presently posted as Executive Director General (EDG) (BS-21), Privatization Commission, under Section 10 of Civil Servants Act, 1973, is promoted to BS-21 in that Group, on regular basis, with immediate effect.

On promotion, Mr. Muhammad Khurshid, is posted as EDG (BS-21), Privatization Commission, on deputation basis, on standard terms and conditions, until further orders.

No. F.40/631/2021-E-I.—Mr. Tariq Rashid, a BS-20 Officer of Secretariat Group, presently posted as Chief Executive Officer (CEO), Pakistan Housing Authority (PHA), under Housing & Works Division, on deputation basis, is promoted to BS-21 in that Group, on regular basis, with immediate effect.

On promotion, Mr. Tariq Rashid, shall remain posted as CEO, PHA, until further orders.

No. F.40/632/2021-E-I.—Ms. Samar Ihsan, a BS-20 Officer of Secretariat Group, presently posted as Joint Secretary, Economic Affairs Division, is promoted to BS-21 in that Group, on regular basis, with immediate effect.

On promotion, Ms. Samar Ihsan, is posted as Senior Joint Secretary, Economic Affairs Division, until further orders.

No. F.39/1096/2021-E-I.—Mr. Rehan Saleem, a BS-19 Officer of Secretariat Group, presently posted as Joint Secretary, Defence Production Division, under Section 10 of Civil Servants Act, 1973, is promoted to BS-20 in that Group, on regular basis, with immediate effect.

On promotion, Mr. Rehan Saleem, is posted as Joint Secretary, Defence Production Division, until further orders.

No. F.39/1104/2021-E-I.—Mr. Muhammad Irfan Khan, a BS-19 Officer of Secretariat Group, presently posted at the disposal of Housing & Works Division, for further

posting as Director, Pakistan Housing Authority (PHA) on deputation basis, is promoted to BS-20 in that Group, on regular basis, with immediate effect.

On promotion, Mr. Muhammad Irfan Khan, is transferred and posted as Director General, PHA, on deputation basis, on standard terms and conditions, until further orders.

No. F.39/1097/2021-E-I.—Ms. Ayesha Zareen Siddique, a BS-19 Officer of Secretariat Group, presently at the disposal of Civil Service Academy (CSA) Lahore, under Section 10 of Civil Servants Act, 1973, is promoted to BS-20 in that Group, on regular basis, with immediate effect.

On promotion, services of Ms. Ayesha Zareen Siddique, shall remain at the disposal of CSA, Lahore, under Section 10 of Civil Servants Act, 1973, until further orders.

No. F.39/1103/2021-E-I.—Mr. Muhammad Mureed Rahimoon, a BS-19 Officer of Secretariat Group, presently posted as Joint Secretary, National Heritage & Culture Division, under Section 10 of Civil Servants Act, 1973, is promoted to BS-20 in that Group, on regular basis, with immediate effect.

On promotion, Mr. Muhammad Mureed Rahimoon, is posted as Joint Secretary, National Heritage & Culture Division, until further orders.

No. F.39/1105/2021-E-I.—Mr. Arshad Farid Khan, a BS-19 Officer of Secretariat Group, presently posted as Joint Secretary, Religious Affairs & Interfaith Harmony Division, under Section 10 of Civil Servants Act, 1973, is promoted to BS-20 in that Group, on regular basis, with immediate effect.

On promotion, Mr. Arshad Farid Khan, is posted as Joint Secretary, Religious Affairs & Interfaith Harmony Division, until further orders.

No. F.39/1101/2021-E-I.—Mr. Kamran Farooq Ansari, a BS-19 Officer of Secretariat Group, presently posted as Joint Secretary, Maritime Affairs Division, under Section 10 of Civil Servants Act, 1973, is promoted to BS-20 in that Group, on regular basis, with immediate effect.

On promotion, Mr. Kamran Farooq Ansari, is posted as Joint Secretary, Maritime Affairs Division, until further orders.

No. F.39/1100/2021-E-I.—Ms. Khalida Bashir, a BS-19 officer of Secretariat Group, presently at the disposal of National School of Public Policy (NSSP), Lahore, under Section 10 of Civil Servants Act, 1973, is promoted to BS-20 in that Group, on regular basis, with immediate effect.

On promotion, service of Ms. Khalida Bashir, shall remain at the disposal of NSPP, Lahore, under Section 10 of Civil Servants Act, 1973, until further orders.

No. F.39/1099/2021-E-I.—Mr. Abdul Shabbir Khan Khattak, a BS-19 officer of Secretariat Group, presently at the disposal of Supreme Court of Pakistan, Islamabad, under Section 10 of Civil Servants Act, 1973, is promoted to BS-20 in that Group, on regular basis, with immediate effect.

On promotion, services of Mr. Abdul Shabbir Khan Khattak are placed at the disposal of Supreme Court of Pakistan, Islamabad, on deputation basis, on standard terms and conditions, until further orders.

No. F.39/1106/2021-E-I.—Mr. Muhammad Pervaiz Alam, a BS-19 officer of Secretariat Group, presently posted as Deputy Secretary, Finance Division, is promoted to BS-20 in that Group, on regular basis, with immediate effect.

On promotion, Mr. Muhammad Pervaiz Alam, is posted as Joint Secretary, Finance Division, until further orders.

No. F.39/1107/2021-E-I.—Mr. Waqar Hussain Abbasi, a BS-19 officer of Secretariat Group, presently posted as Deputy Secretary, Human Rights Division, is promoted to BS-20 in that Group, on regular basis, with immediate effect.

On promotion, Mr. Waqar Hussain Abbasi, is transferred and posted as Joint Secretary, Inter Provincial Coordination (IPC) Division, until further orders.

No. F.39/1098/2021-E-I.—Ms. Samreen Zahara, a BS-19 officer of Secretariat Group, presently posted as Joint Secretary, Privatisation Division, under 10 of Civil Servants Act, 1973, is promoted to BS-20 in that Group, on regular basis, with immediate effect.

On promotion, Ms. Samreen Zahara, is posted as Joint Secretary, Privatisation Division, until further orders.

No. F.39/1109/2021-E-I.—Mr. Muhammad Jamil, a BS-19 officer of Secretariat Group, presently posted as Director General (BS-20), Privatisation Commission, under Section 10 of Civil Servants Act, 1973, is promoted to BS-20 in that Group, on regular basis, with immediate effect.

On promotion, Mr. Muhammad Jamil, is posted as Director General (BS-20), Privatisation Commission, on deputation basis, on standard terms and Conditions, until further orders.

No. F.39/1108/2021-E-I.—Syed Sibte-Abbas Zaidi, a BS-19 officer of Secretariat Group, presently posted as Deputy Secretary, National Heritage & Culture Division, is promoted to BS-20 in that Group, on regular basis, with immediate effect.

On promotion, Syed Sibte-Abbas Zaidi, is transferred and posted as Joint Secretary, Law & Justice Division, until further orders.

No. F.39/1122/2021-E-I.—Mr. Muhammad Riaz, a BS-19 officer of Secretariat Group, presently posted as Deputy Secretary, Finance Division, is promoted to BS-20 in that Group, on regular basis, with immediate effect.

On promotion, Mr. Muhammad Riaz, is transferred and posted as Joint Secretary, National Health Services, Regulations & Coordination Division, until further orders.

No. F.39/1123/2021-E-I.—Mr. Mumtaz Hussain Shah a BS-19 officer of Secretariat Group, presently posted as Director, President Secretariat (Public), on deputation basis, is promoted to BS-20 in that Group, on regular basis, with immediate effect.

On promotion, Mr. Mumtaz Hussain Shah, is transferred and posted as Joint Secretary, Finance Division, until further orders.

No. F.39/1124/2021-E-I.—Mr. Muhammad Shamim Khan, a BS-19 Officer of Secretariat Group, presently posted as Deputy Secretary, Finance Division, is promoted to BS-20 in that Group, on regular basis, with immediate effect.

On promotion, Mr. Muhammad Shamim Khan, is posted as Joint Secretary, Finance Division, until further orders.

No. F.39/1125/2021-E-I.—Mr. Tariq Mahmood, a BS-19 Officer of Secretariat Group, presently posted as Director General (BS-20), Benazir Income Support Programme (BISP), under Section 10 of Civil Servants Act, 1973, is promoted to BS-20 in that Group, on regular basis, with immediate effect.

On promotion, Mr. Tariq Mahmood, is posted as Director General (BS-20), BISP, on deputation basis, on standard terms and conditions, until further orders.

No. F.39/1126/2021-E-I.—Mr. Amjad Ahmad, a BS-19 Officer of Secretariat Group, presently posted as Joint Secretary, Religious Affairs & Interfaith Harmony Division, under Section 10 of Civil Servants Act, 1973, is promoted to BS-20 in that Group, on regular basis, with immediate effect.

On promotion, Mr. Amjad Ahmad, is posted as Joint Secretary, Religious Affairs & Interfaith Harmony Division, until further orders.

No. F.39/1127/2021-E-I.—Dr. Imran Ullah Khan, a BS-19 Officer of Secretariat Group, presently posted as Joint Secretary, Finance Division, under Section 10 of Civil Servants Act, 1973, is promoted to BS-20 in that Group, on regular basis, with immediate effect.

On promotion, Dr. Imran Ullah Khan, is posted as Joint Secretary, Finance Division, until further orders.

No. F.39/1128/2021-E-I.—Mrs. Shabnam Amir Khan, a BS-19 Officer of Secretariat Group, presently posted as Joint Secretary, Establishment Division, under Section 10 of

Civil Servants Act, 1973, is promoted to BS-20 in that Group, on regular basis, with immediate effect.

On promotion, Mrs. Shabnam Amir Khan, is posted as Joint Secretary, Establishment Division, until further orders.

No. F.39/1133/2021-E-I.—Mrs. Nasira Batool Jafri, a BS-19 Officer of Secretariat Group, presently posted as Joint Secretary, Defence Division, under Section 10 of Civil Servants Act, 1973, is promoted to BS-20 in that Group, on regular basis, with immediate effect.

On promotion, Mrs. Nasira Batool Jafri, is posted as Joint Secretary, Defence Division, until further orders.

No. F.39/1134/2021-E-I.—Mr. Mukhtar Paras Shah, a BS-19 Officer of Secretariat Group, presently posted as Director General (BS-20), Secretariat Training Institute (STI), under Section 10 of Civil Servants Act, 1973, is promoted to BS-20 in that Group, on regular basis, with immediate effect.

On promotion, Mr. Mukhtar Paras Shah, is posted as Director General (BS-20), STI, on deputation basis, on standard terms and conditions, until further orders.

No. F.39/1135/2021-E-I.—Mr. Sajjad Haider Yaldram, a BS-19 Officer of Secretariat Group, presently posted as Deputy Secretary, Power Division, is promoted to BS-20 in that Group, on regular basis, with immediate effect.

On promotion, Mr. Sajjad Haider Yaldram, is transferred and posted as Joint Secretary, Finance Division (Military Finance Wing), until further orders.

No. F.39/1136/2021-E-I.—Mr. Imran Jamil Shami, a BS-19 Officer of Secretariat Group, presently posted as Director General (BS-20), Privatisation Commission, under Section 10 of Civil Servants Act, 1973, is promoted to BS-20 in that Group, on regular basis, with immediate effect.

On promotion, Mr. Imran Jamil Shami, is posted as Director General (BS-20), Privatisation Commission, on deputation basis, on standard terms and conditions, until further orders.

No. F.39/1137/2021-E-I.—Mr. Tahir Qurban, a BS-19 Officer of Secretariat Group, presently posted as Deputy Secretary, Azad Jammu & Kashmir Council Secretariat, on deputation basis, is promoted to BS-20 in that Group, on regular basis, with immediate effect.

On promotion, Mr. Tahir Qurban, is transferred and posted as Joint Secretary, Interior Division, until further orders.

No. F.39/1129/2021-E-I.—Syed Ahsan Mumtaz, a BS-19 Officer of Secretariat Group, presently posted as Joint Secretary, National Food Security & Research Division, under Section 10 of Civil Servants Act, 1973, is

promoted to BS-20 in that Group, on regular basis, with immediate effect.

On promotion, Syed Ahsan Mumtaz, is posted as Joint Secretary, National Food Security & Research Division, until further orders.

No. F.39/1130/2021-E-I.—Mr. Muhammad Din Chakrani, a BS-19 Officer of Secretariat Group, presently posted as Director General (Investment), Employees Old Age Benefit Institution (EOBI), under Overseas Pakistanis & Human Resource Development Division, is promoted to BS-20 in that Group, on regular basis, with immediate effect.

On promotion, Mr. Muhammad Din Chakrani, is transferred and posted as Joint Secretary, Planning Development & Special Initiatives Division, until further orders.

No. F.39/1131/2021-E-I.—Mr. Ahmed Nadeem Khan, a BS-19 Officer of Secretariat Group, presently at the disposal of National School of Public Policy (NSPP), Lahore, on deputation basis, is promoted to BS-20 in that Group, on regular basis, with immediate effect.

On promotion, services of Mr. Ahmed Nadeem Khan shall remain at the disposal of NSPP, Lahore, on deputation basis, on standard terms and conditions, until further orders.

No. F.39/1132/2021-E-I.—Ms. Nabeela Umar, a BS-19 Officer of Secretariat Group, presently posted as Director, National Vocational & Technical Training Commission (NAVTTTC), Regional Office, Karachi, under Wed Lock Policy, is promoted to BS-20 in that Group, on regular basis, with immediate effect.

On promotion, Ms. Nabeela Umar, is transferred and posted as Joint Secretary, Finance Division (Military Finance Wing), until further orders.

No. F.39/1110/2021-E-I.—Mr. Amjad Ali, a BS-19 Officer of Secretariat Group, presently posted as Director, President Secretariat (Public), on deputation basis, is promoted to BS-20 in that Group, on regular basis, with immediate effect.

On promotion, Mr. Amjad Ali, is transferred and posted as Joint Secretary, Housing & Works Division, until further orders.

No. F.39/1111/2021-E-I.—Mr. Khan Nawaz, a BS-19 Officer of Secretariat Group, presently posted as Member (Finance), Heavy Industries Taxila Board (HITB), under Section 10 of Civil Servants Act, 1973, is promoted to BS-20 in that Group, on regular basis, with immediate effect.

On promotion, Mr. Khan Nawaz, is posted as Member (Finance), HITB, on deputation basis, on standard terms and condition, until further orders.

No. F.39/1112/2021-E-I.—Mr. Muhammad Wishaq, a BS-19 Officer of Secretariat Group, presently posted as Deputy Secretary, Prime Minister's Office, Islamabad, on deputation basis, is promoted to BS-20 in that Group, on regular basis, with immediate effect.

On promotion, Mr. Muhammad Wishaq, is posted as Joint Secretary, Prime Minister's Office, until further orders.

No. F.39/1113/2021-E-I.—Mr. Waqar-ud-Din Siddiqui, a BS-19 Officer of Secretariat Group, presently posted as Joint Secretary, Industries & Production Division, under Section 10 of Civil Servants Act, 1973, is promoted to BS-20 in that Group, on regular basis, with immediate effect.

On promotion, Mr. Waqar-ud-Din Siddiqui, is posted as Joint Secretary, Industries & Production Division, until further orders.

No. F.39/1114/2021-E-I.—Mr. Iftikhar Hussain Naqvi, a BS-19 Officer of Secretariat Group, presently posted as Director General (BS-20), Privatisation Commission, under Section 10 of Civil Servants Act, 1973, is promoted to BS-20 in that Group, on regular basis, with immediate effect.

On promotion, Mr. Iftikhar Hussain Naqvi, is posted as Director General (BS-20), Privatisation Commission, on deputation basis, on standard terms and conditions, until further orders.

No. F.39/1115/2021-E-I.—Mr. Farooq Sultan Khattak, a BS-19 Officer of Secretariat Group, presently at the disposal of Benazir Income Support Programme (BISP), KP Region, on deputation basis, is promoted to BS-20 in that Group, on regular basis, with immediate effect.

On promotion, Mr. Farooq Sultan Khattak, is transferred and posted as Joint Secretary, Finance Division (Military Finance Wing), until further orders.

No. F.39/1116/2021-E-I.—Mr. Shahzad Ahmad, a BS-19 Officer of Secretariat Group, presently posted as Deputy Secretary, Finance Division, is promoted to BS-20 in that Group, on regular basis, with immediate effect.

On promotion, Mr. Shahzad Ahmad, is posted as Joint Secretary, Aviation Division until further orders.

This Division's Notification No.1-46/2009-E-2 dated 28th August, 2020 is hereby withdrawn *ab-initio*.

No. F.39/1117/2021-E-I.—Mr. Riaz Ahmed, a BS-19 Officer of Secretariat Group, presently posted as Deputy Secretary, Finance Division, is promoted to BS-20 in that Group, on regular basis, with immediate effect.

On promotion, Mr. Riaz Ahmed, is transferred and posted as Joint Secretary, Economic Affairs Division, until further orders.

No. F.39/1118/2021-E-I.—Mr. Faisal Nisar Ch, a BS-19 Officer of Secretariat Group, presently at the disposal of Government of Punjab, on deputation basis, is promoted to BS-20 in that Group, on regular basis, with immediate effect.

On promotion, Mr. Faisal Nisar Ch, is transferred and posted as Joint Secretary, Interior Division, until further orders.

No. F.39/1119/2021-E-I.—Rana Muhammad Aslam, a BS-19 Officer of Secretariat Group, presently posted as Deputy Secretary, Economic Affairs Division, is promoted to BS-20 in that Group, on regular basis, with immediate effect.

On promotion, Rana Muhammad Aslam, is posted as Joint Secretary Economic Affairs Division, until further orders.

No. F.39/1121/2021-E-I.—Mr. Abdul Malik, a BS-19 Officer of Secretariat Group, presently posted as Deputy Secretary, Finance Division, is promoted to BS-20 in that Group, on regular basis, with immediate effect.

On promotion, Mr. Abdul Malik, is transferred and posted as Joint Secretary, Religious Affairs & Interfaith Harmony Division, until further orders.

No. F.39/1138/2021-E-I.—Mr. Muhammad Ramzan, a BS-19 Officer of Secretariat Group, presently posted as Deputy Secretary, Prime Minister's Office (Public), on deputation basis, is promoted to BS-20 in that Group, on regular basis, with immediate effect.

On promotion, Mr. Muhammad Ramzan, is transferred and posted as Joint Secretary, Interior Division, until further orders.

No. F.39/1139/2021-E-I.—Mr. Asif Ali Alvi, a BS-19 Officer of Secretariat Group, presently posted as Deputy Secretary, Finance Division, is promoted to BS-20 in that Group, on regular basis, with immediate effect.

On promotion, Mr. Asif Ali Alvi, is transferred and posted as Joint Secretary, Finance Division (Military Finance Wing), until further orders.

No. F.39/1140/2021-E-I.—Mr. Nazir Ahmed, a BS-19 Officer of Secretariat Group, presently posted as Deputy Secretary, Cabinet Division, is promoted to BS-20 in that Group, on regular basis, with immediate effect.

On promotion, Mr. Nazir Ahmed, is posted as Joint Secretary, Cabinet Division, until further orders.

No. F.39/1142/2021-E-I.—Mr. Mazhar ul Hassan Shah, a BS-19 Officer of Secretariat Group, presently posted as Deputy Secretary, Finance Division is promoted to BS-20 in that Group, on regular basis, with immediate effect.

On promotion, Mr. Mazhar ul Hassan Shah, is transferred and posted as Joint Secretary, Commerce Division, until further orders.

No. F.39/1094/2021-E-I.—Mr. Ghulam Mujtaba Joyo, a BS-19 Officer of Secretariat Group, presently posted as Joint Secretary, Cabinet Division, under Section 10 of Civil Servants Act, 1973, is promoted to BS-20 in that Group, on regular basis, with immediate effect.

On promotion, Mr. Ghulam Mujtaba Joyo, is posted as Joint Secretary, Cabinet Division, until further orders.

No. 1-11/2014-E-2.—Mr. Saeed Ahmad Malik, a BS-19 Officer of the Secretariat Group, presently at the disposal of National Highway Authority (NHA) under Communication Division under Section 10 of Civil Servants Act, 1973 is granted extension for further period of one year with effect from 1st February, 2021.

Islamabad, the 1st March, 2021

No. F.29/1/2017-E-I.—This Division's notification of even number dated 20th December, 2019, regarding posting of Ray Muhammad Nasir Ali Khan, a BS-21 Officer of Economist and Planners Group, presently posted as Joint Chief Economist, Planning Development & Reform Division, as Senior Joint Secretary, Textile/ Commerce Division, is hereby withdrawn *ab-initio*.

No. F.39/1117/2021-E-I.—Mr. Riaz Ahmed, a BS-19 Officer of Secretariat Group, presently posted as Deputy Secretary, Finance Division, is promoted to BS-20 in that Group, on regular basis, with effect from 26th February, 2021.

On promotion, Mr. Riaz Ahmed, is transferred and posted as Joint Secretary, Communications Division, until further orders.

This Division's notification of even number dated 26th February, 2021 is hereby withdrawn *ab-initio*.

No. F.39/1110/2021-E-I.—Mr. Amjad Ali, a BS-19 Officer of Secretariat Group, presently posted as Director, President Secretariat (Public), on deputation basis, is promoted to BS-20 in that Group, on regular basis, with effect from 26th February, 2021.

On promotion, Mr. Amjad Ali, is transferred and posted as Joint Secretary, Religious Affairs & Interfaith Harmony Division, until further orders.

This Division's notification of even number dated 26th February, 2021 is hereby withdrawn *ab-initio*.

No. F.39/1107/2021-E-I.—Mr. Waqar Hussain Abbasi, a BS-19 Officer of Secretariat Group, presently posted as Deputy Secretary, Human Rights Division, is promoted to BS-20 in that Group, on regular basis, with effect from 26th February, 2021.

On promotion, Mr. Waqar Hussain Abbasi, is transferred and posted as Joint Secretary, Defence Division, until further orders.

This Division's notification of even number dated 26th February, 2021 is hereby withdrawn *ab-initio*.

No. F.39/1130/2021-E-I.—Mr. Muhammad Din Chakrani, a BS-19 Officer of Secretariat Group, presently posted as Director General (Investment), Employees Old Age Benefit Institution (EOBI), under Overseas Pakistanis & Human Resource Development Division, is promoted to BS-20 in that Group, on regular basis, with effect from 26th February, 2021.

On promotion, Mr. Muhammad Din Chakrani, is transferred and posted as Joint Secretary, Commerce Division, until further orders.

This Division's notification of even number dated 26th February, 2021 is hereby withdrawn *ab-initio*.

No. F.39/1124/2021-E-I.—Mr. Muhammad Shamim Khan, a BS-19 Officer of Secretariat Group, presently posted as Director General, Privatisation Commission, under Section 10 of Civil Servants Act, 1973, is promoted to BS-20 in that Group, on regular basis, with effect from 26th February, 2021.

On promotion, Mr. Muhammad Shamim Khan, is posted as Director General, Privatisation Commission, on deputation basis, on standard terms and conditions, until further orders.

This Division's notification of even number dated 26th February, 2021 is hereby withdrawn *ab-initio*.

No. F.11/16/2017-E-1.—In pursuance of Office of Auditor General of Pakistan Notification No.14-Dir(A)/2-3/21 dated 26th February, 2021 Mr. Jehangir Mushtaq Virk, a BS-19 Officer of Pakistan Audit and Accounts Service, presently posted as Joint Secretary, Establishment Division, under Section 10 of Civil Servants Act, 1973, is promoted to BS-20 in that Group, on regular basis, with effect from 26th February, 2021.

On promotion, the officer shall remain posted as Joint Secretary, Establishment Division, under Section 10 of Civil Servants Act, 1973, until further orders.

No. F.11/16/2017-E-1.—In pursuance of Office of Auditor General of Pakistan Notification No.14-Dir(A)2-3/21 dated 26th February, 2021, the transfer/ posting of the following BS-19 Officer of Pakistan Audit & Accounts Service (PA&AS), on her regular promotion to BS-20/ equivalent, is ordered, with effect from 26th February, 2021 and until further orders:-

S. No.	Name of Officer (M/S)	From	To
1.	Shazana Durrani	Chief Finance & Accounts Officer, Establishment Division, Islamabad (ACB).	Chief Finance & Accounts Officer, Establishment Division, Islamabad.

No. F.39/1121/2021-E-I.—Mr. Abdul Malik, a BS-19 Officer of Secretariat Group, presently posted as Deputy Secretary, Finance Division, is promoted to BS-20 in that Group, on regular basis, with effect from 26th February, 2021.

On promotion, Mr. Abdul Malik, is posted as Joint Secretary, Finance Division, until further orders.

This Division's notification of even number dated 26th February, 2021 is hereby withdrawn *ab-initio*.

Islamabad, the 2nd March, 2021

No. F.34/07/2015-E-1.—Ms. Aiysha Khalid, a BS-20 Officer of Inland Revenue Service, presently posted as Joint Secretary, Federal Education & Professional Training Division, is transferred and repatriated to her parent department *i.e.* Federal Board of Revenue, with immediate effect or from the date of relinquished of charge, whichever is earlier.

Islamabad, the 3rd March, 2021

No. F.1-18/2011-E-2.—In partial modification of this Division's notification of even number dated 23rd September, 2020, Mr. Mazhar ul Hassan Shah, a BS-20 Officer of Secretariat Group, presently posted as Joint Secretary, Commerce Division, shall stand retired from Government Service, on attaining the age of superannuation, on 2nd March, 2021.

Islamabad, the 4th March, 2021

No. F.39/1065/2017-E-1.—Mr. Khial Zad Gul, a BS-20 Officer of Secretariat Group, presently posted as Joint Secretary, Climate Change Division, is transferred and posted as Joint Secretary, Parliamentary Affairs Division, with immediate effect and until further orders.

No. F.24/06/2011-E-I.—Consequent upon his repatriation *vide* Establishment Division's notification of even number dated 20th August, 2019 Mr. Khusdil Khan Malik a BS-20 Officer of Federal Government Education Institutions (Cantonments/ Garrisons) Directorate, Rawalpindi stands relieved of duties and directed to report to Defence Division.

Islamabad, the 5th March, 2021

No. 1-46/2013-E-2.—Mr. Muhammad Zahid Mustafa, a BS-19 Officer of the Secretariat Group, presently posted as Deputy Secretary, Overseas Pakistanis and Human Resource Development Division, is transferred and posted as Deputy Secretary, Prime Minister's Office (Public), with immediate effect and until further orders.

Islamabad, the 8th March, 2021

No. F.31/05/2020-E-1.—Mr. Nadir Mumtaz Warraich, a BS-22 Officer of Inland Revenue Service, presently at the disposal of Federal of Revenue, is transferred and posted as Special Secretary (BS-22), Maritime Affairs Division, by upgrading and re-designating the post of Additional Secretary (BS-21) as Special Secretary (BS-22) as personal to the officer, with immediate effect and until further orders.

No. F.29/01/2017-E-I.—Dr. Javed Humayun, a BS-21 Officer of Economist and Planners Group, presently posted as Senior Joint Secretary, National Food Security & Research Division, is transferred and directed to report to his parent Department *i.e.* Planning Development & Special Initiatives Division, with immediate effect.

No. F.29/01/2017-E-I.—Ray Muhammad Nasir Ali Khan, a BS-21 Officer of Economist and Planners Group, presently posted as Joint Chief Economist Planning Development & Special Initiatives Division, is transferred and posted as Senior Joint Secretary, National Food Security & Research Division, with immediate effect and until further orders.

No. F.12/03/2018-E-1.—In pursuance of Office of Auditor General of Pakistan Notification No.15-Dir(A)2-2/21 dated 26th February, 2021, Mr. Dost Ali Shah, a BS-20 Officer of Pakistan Audit and Accounts Service, presently

posted as Joint Secretary/ Financial Adviser, Finance Division (Military Finance Wing), is promoted to BS-21 in that group, on regular basis, with effect from 26th February, 2021.

On promotion, the officer is posted as Senior Joint Secretary/ Financial Adviser, Finance Division (Military Finance Wing), until further orders.

No. F.12/05/2018-E-I.—Mr. Muhammad Ikram, a BS-20 Officer of Economist and Planners Group, presently posted as Chief Economist, Planning, Development & Special Initiatives Division, is transferred and posted as Joint Secretary, Overseas Pakistanis & Human Resource Development Division, with immediate effect and until further orders.

No. F.12/05/2018-E-I.—Mr. Tassaduq Hussain, a BS-20 Officer of Economist and Planners Group, presently posted as Joint Secretary, Overseas Pakistanis & Human Resource Development Division, is transferred and directed to report to his parent Department *i.e.* Planning Development & Special Initiatives Division, with immediate effect.

No. F.11/16/2017-E-I.—The transfers/ postings of the following BS-20 Officers of Office of Auditor General of Pakistan, with immediate effect and until further orders:-

S. No.	Name of Officers (M/S)	From	To
1.	Tariq Bashir Chattha	Awaiting for posting at the AGP office, Islamabad	Chief Finance & Accounts Officer, Parliamentary Affairs Division, Islamabad
2.	Javed Zia Burney	Director General Audit, LC, Sindh, Karachi	Chief Finance & Accounts Officer, Housing & Works Division, Islamabad

S. No.	Name of Officers (M/S)	From	To
3.	Shahzad Naim	Director (Finance), KRL, Rawalpindi.	Chief Finance & Accounts Officer, Science & Technology Division, Islamabad.
4.	Zulfiqar Ali	Awaiting posting on return from leave.	Chief Finance & Accounts Officer, Planning Development & Special Initiatives Division, Islamabad.
5.	Zia-ul-Islam Khan Niazi	Chief Finance & Accounts Officer, Planning Development & Special Initiatives Division, Islamabad.	Repatriated to parent department for further posting.

No. F. 11/16/2017-E-I.—In pursuance of office of Auditor General of Pakistan Notification No. 14-Dir(A)/2-3/21 dated 26th February, 2021. The transfers/postings of the following BS-19 officers of Pakistan Audit & Accounts Service (PA&AS), on their regular promotion to BS-20/equivalent, are ordered, with effect from 26th February, 2021 and until further orders:-

S. No.	Name of Officers (M/S)	From	To
1.	Sajid Mehmood Raja	Chief Finance & Accounts Officer, Interior Division, Islamabad (OPS).	Chief Finance & Accounts Officer, Interior Division, Islamabad.
2.	Asad Ullah Khan	Director, District Audit KP, Kohat	Chief Finance & Accounts Officer, Maritime Affairs Division, Islamabad.
3.	Muhammad Saeed Tiwana	Chief Finance & Accounts Officer, Information Technology & Telecommunication Division, Islamabad (OPS).	Chief Finance & Accounts Officer, Information Technology & Telecommunication Division, Islamabad.
4.	Waseem Arshad	Chief Finance & Accounts Officer, Communications Division, Islamabad (OPS).	Chief Finance & Accounts Officer, Communications Division, Islamabad.
5.	Muhammad Asif	Director/Principal MATI, Rawalpindi.	Chief Finance & Accounts Officer, Railways Division, Islamabad.
6.	Iffat Farooq (Mrs)	Director Staff (SMC), NIM, Lahore.	Chief Finance & Accounts Officer, National Health Services, Regulations & Coordination Division, Islamabad.
7.	Aijaz Ali	Director, Audit, (Railways), Lahore.	Chief Finance & Accounts Officer, Industries & Production Division, Islamabad.
8.	Azhar Khaliq	General Manager (Audit), SPARCO, Karachi.	Chief Finance & Accounts Officer, Kashmir Affairs and Gilgit Baltistan Division, Islamabad.
9.	Shuja Ali	Director, PAAA, Quetta.	Chief Finance & Accounts Officer, Economic Affairs Division, Islamabad.

No. F. 1-4/2014-E-2.—Mr. Rohail Aziz Quidwai, a BS-19 officer of the Secretariat Group, presently at the disposal of Petroleum Division, is directed to report to Establishment Division, with effect from 1st March, 2021.

Islamabad, the 9th March, 2021

No. F. 39/1049/2017-E-1.—Mr. Shahid Ahmed Sandhu, a BS-20 officer of Secretariat Group, presently posted as Joint Secretary, Religious Affairs & Interfaith Harmony Division, is transferred and his services are placed at the disposal of President's Secretariat (Public) for his further posting as Director General, President's Secretariat (Public), on deputation basis, on standard terms & conditions, with immediate effect and until further orders.

No. F. 55/3/2017-E-1.—Mr. Kamran Rashid Khan, a BS-20 officer of Pakistan Audit & Accounts Service (PA&AS), presently posted as Joint Secretary/Financial Adviser, Finance Division (Military Finance Wing), is repatriated to his parent department *i.e.* Office of Auditor General of Pakistan, with immediate effect.

Islamabad, the 10th March, 2021

No. F. 1/28/2020-E-6/E-8.—The competent authority is pleased to appoint Mr. Altaf Ahmad, as Digital Communication Officer (MP-III Scale), Digital Media Wing, Information and Broadcasting Division, with immediate effect and until further orders.

The tenure of appointment will be in accordance with the Finance Division's O.M. No. F. 3(2)R-4/2011 dated 14th July, 2017.

No. F. 1/28/2020-E-6/E-8.—The competent authority is pleased to appoint Ms. Maria Talpur, as Digital Media Consultant (MP-III Scale), Digital Media Wing, Information and Broadcasting Division, with immediate effect and until further orders.

The tenure of appointment will be in accordance with the Finance Division's O.M. No. F. 3(2)R-4/2011 dated 14th July, 2017.

Islamabad, the 11th March, 2021

No. F. 3-45/2019-E-2.—Mr. Zia-ur-Rehman, a BS-19 officer of Pakistan Railways (Commercial & Transportation Group), presently posted as Deputy Secretary, Poverty Alleviation & Social Safety Division is transferred and posted as Deputy Secretary, Prime Minister's Office (Public) with immediate effect and until further orders.

Islamabad, the 12th March, 2021

No. F. 1-47/2011-E-2.—Rana Muhammad Yousaf Khan, a BS-19 officer of Secretariat Group, presently posted as Deputy Secretary, Federal Education and Professional Training Division is transferred and posted as Deputy Secretary, Interior Division with immediate effect and until further orders.

Islamabad, the 16th March, 2021

No. F. 40/646/2021-E-I.—Mr. Munir Ahmed, a BS-20 officer of Secretariat Group, presently posted as Joint Secretary, Finance Division, is promoted to BS-21 in that Group, on regular basis, with effect from 4th March, 2021.

On promotion, Mr. Munir Ahmed, is posted as Senior Joint Secretary, Finance Division, with immediate effect and until further orders.

No. F. 39/1141/2021-E-I.—Mr. Muhammad Iqbal Asif, a BS-19 officer of Secretariat Group, presently posted as Deputy Secretary, Aviation Division, is promoted to BS-20 in that Group, on regular basis, with effect from 2nd March, 2021.

On promotion, Mr. Muhammad Iqbal Asif, is posted as Joint Secretary, Aviation Division, with immediate effect and until further orders.

No. F. 39/1102/2021-E-I.—Mr. Ahmed Jan Malik, a BS-19 officer of Secretariat Group, presently posted as Joint Secretary, Poverty Alleviation & Social Safety Division, under Section 10 of Civil Servants Act, 1973, is promoted to BS-20 in that Group, on regular basis, with effect from 26th February, 2021.

On promotion, Mr. Ahmed Jan Malik, is posted as Joint Secretary, Poverty Alleviation & Social Safety Division, with immediate effect and until further orders.

No. F. 39/1122/2021-E-I.—Mr. Muhammad Riaz, a BS-19 officer of Secretariat Group, presently posted as Deputy Secretary, Finance Division, is promoted to BS-20 in that Group, on regular basis, with effect from 26th February, 2021.

On promotion, Mr. Muhammad Riaz, is transferred and posted as Joint Secretary, Cabinet Division, to act as Secretary, Assets Recovery Unit (ARU) under Cabinet Division, with immediate effect and until further orders.

This Division's notification of even number dated 26th February, 2021 is hereby withdrawn *ab-initio*.

No. F. 39/1120/2021-E-I.—Mir Afzal Khan, a BS-19 officer of Secretariat Group, presently posted at the disposal of Federal Board of Revenue (FBR), is promoted to BS-20 in that Group, on regular basis, with effect from 1st March, 2021.

On promotion, Mir Afzal Khan, is transferred and posted as Joint Secretary, National Health Services, Regulations & Coordination Division, with immediate effect and until further orders.

No. F. 39/1053/2017-E-I.—Dr. Mirza Ali Mahsud, a BS-20 officer of Secretariat Group, presently posted as Joint Secretary, Interior Division, is transferred and posted as Joint Secretary, Religious Affairs & Interfaith Harmony Division, with immediate effect and until further orders.

No. F. 5/4/2014-E-I.—Mr. Manzoor Ahmad Kiyani, a BS-20 officer of Pakistan Audit & Accounts Service (PA&AS), presently posted as Joint Secretary, Cabinet Division, is repatriated to his parent department *i.e.* Office of Auditor General of Pakistan, with immediate

effect or from the date of relinquishment of charge, whichever is earlier.

OBITUARY

No. F. 39/1048/2015-E-1.—Government of Pakistan, with great sorrows, announces the tragic demise of Mr. Muhammad Arshad Khan, a BS-20 officer of Secretariat Group on 9th March, 2021.

2. Mr. Muhammad Arshad Khan joined government service on the 6th of November, 1996 in the 24th Common Training Program. He had earned M.A. degree in English Literature from Government Gordon College, Rawalpindi.

3. Mr. Muhammad Arshad Khan served in the Federal Government in various capacities in the Office Management Group and the Secretariat Group. Lastly he was posted as Joint Secretary, Aviation Division.

4. Wherever Mr. Muhammad Arshad Khan served, he served with zeal and fervor. His colleagues, seniors and juniors alike, held him in great reverence. His death has deprived the Government of Pakistan of an outstanding officer.

5. The Government of Pakistan wishes to place on record its appreciation of the dedicated services rendered by the deceased.

6. Government of Pakistan extends its deepest condolences to the bereaved family of Mr. Muhammad Arshad Khan, May Allah rest his soul in eternal peace and bestow forbearance upon the grieving hearts of his family. Ameen.

No. F. 23/01/2019-E-1.—Mr. Muhammad Saeedullah Khan Niazi, a BS-19 officer of Pakistan Audit & Accounts Service (PA&AS), presently posted as Joint Secretary, National Health Services, Regulations & Coordination Division, under Section 10 of Civil Servants Act, 1973, is repatriated to his parent department *i.e.* Office of Auditor General of Pakistan, with immediate effect.

No. 1-28/2012-E-2.—Mr. Naeem Iqbal, a BS-19 officer of the Secretariat Group, presently posted as Deputy Secretary, Planning, Development and Special Initiatives Division is transferred and posted as Deputy Secretary, Prime Minister's Office (Public) with immediate effect and until further orders.

No. 1-40/2013-E-2.—Mr. Khalid Javed, a BS-19 officer of the Secretariat Group, presently posted as Deputy Secretary, Religious Affairs and Interfaith Harmony Division is transferred and posted as Deputy Secretary, Planning, Development and Special Initiatives Division with immediate effect and until further orders.

QURATUL AIN FATIMA, *Flt. Lt. (R)*,
Deputy Secretary.

(Poverty Alleviation & Social Safety Division)

Islamabad, the 25th January, 2021

No. PASSD.SO.P.1-8/2020(Admn).62.—In pursuance of Establishment Division's Notification No. PF(1188)/E-5

(PAS) dated 9th December, 2020, Rani Hafsa Kanwal, a BS-18 Officer of Pakistan Administrative Service has assumed the charge of the post of Section Officer (BS-18), Poverty Alleviation & Social Division, Islamabad on 8th January, 2021.

GUL ZAMAN,
Section Officer (Admn).

[BENAZIR INCOME SUPPORT PROGRAMME]

Islamabad, the 1st January, 2021

CORRIGENDUM

No. F. 1(1010)/BISP/HR/S/2017.—In partial modification of this office notification of even number dated 10th December, 2020, the following sentence is hereby inserted in Para 1:-

"the officer shall be repatriated to his parent department i.e. National Library of Pakistan, Islamabad upon completion of his extended period of deputation on 4th June, 2021"

This issues with the approval of the Secretary, BISP.

Islamabad, the 4th January, 2021

No. 1(811)/BISP/HR/KP/2016.—Malik Zulfiqar Ahmed, Assistant Director (BS-17) of Pakistan Bait-ul-Mal, presently posted as Assistant Director (SPS-17), BISP Regional Office, KPK, on deputation basis, upon completion of his 5th year deputation, shall stand repatriated to his parent department on 18th January, 2021.

This issues with the approval of the Secretary BISP.

No. 1(797)/BISP/HR/KP/2015.—Mr. Ihsan Ullah, Assistant Director BISP Tehsil Office, Banda Daud Shah, is hereby, assigned look after charge of the vacant post of Assistant Director, BISP Tehsil Office, Karak for a period 25 days with effect from 4th January, 2021 to 28th January, 2021, in addition to his own duties, during the leave period of the incumbent of the post.

This issues with the approval of the Director General (Admin & HR), BISP.

MUHAMMAD AHMAD USMANI,
Deputy Director (HR-III).

Islamabad, the 4th January, 2021

No. 1(1004)/BISP/HR/2017.—In terms of Rule 5 (a) of the Revised Leave Rules, 1980 (as amended from time to time), Mr. Nasir Saeed Akhtar Warraich, Director (BS), CT Wing, BISP HQ, Islamabad is granted 14 days leave on full pay with effect from 11th November, 2020 to 26th November, 2020 on account of illness (Covid-19).

This issues with the approval of Secretary, BISP.

MUHAMMAD SALEEM ULLAH,
Deputy Director (HR)/
HQ Establishment.

FEDERAL TAX OMBUDSMAN SECRETARIAT

Islamabad, the 6th January, 2021

No. F. 1(303)/2010-A-I.—With the approval of Hon'ble Federal Tax Ombudsman, Mr. Muhammad Farhan Khan, Deputy Director (BS-18) is hereby appointed as Director (BS-19) in the Federal Tax Ombudsman Secretariat on current charge basis for a period of three months with effect from 23rd December, 2020 and until further orders.

He is entitled to draw 20% Special Pay in terms of Finance Division's O.M. No., F. 2(9)-R-3/85 dated 15th March, 1987.

SAJJAD AHMED,
Assistant Director (Estab).

MINISTRY OF COMMERCE

Islamabad, the 4th January, 2021

No. 7(6)/2017-Admn-I/HR-I.—Hafiz Muhammad Ahmed, BS-18 officer of Commerce & Trade Group, posted as Section Officer (Imp-I), Ministry of Commerce, Islamabad, had been assigned additional charge for the post of Section Officer (Exp-II), Ministry of Commerce with effect from 8th October, 2020 to 30th November, 2020.

This issues with the approval of Secretary Commerce.

No. 7(21)/2020-Admn-I/HR-I.—Consequent upon her request and with approval of the competent authority, i.e. Secretary Commerce, Ms. Sana Shoukat, BS-17 officer of Office Management Group, presently posted as Section Officer, Ministry of Commerce, Islamabad, has been granted eighty eight (88) days leave on half pay (LHP) as per following detail:-

30th November, 2020 to 21st December, 2020	Twenty two (22) days Outstation Leave on Half Pay
22nd December, 2020 to 17th January, 2021	Twenty seven (27) days ex-Pakistan Leave Half Pay
18th January, 2021 to 25th February, 2021	Thirty nine (39) days Outstation Leave on Half Pay.

MUHAMMAD IMTIAZ,
Deputy Director (HR-I).

DEPARTMENT OF THE AUDITOR-GENERAL OF PAKISTAN

Islamabad, the 28th December, 2020

No. 708/PAAS-II/36-2020.—Consequent upon promotion to the post of Deputy Director/equivalent (BS-18) on regular basis vide O/o. Auditor General of Pakistan Islamabad's Notification No. 42/Dir(A)II/CA-II/1-5/P-18/2020 dated 10th December, 2020 and posting/transfer vide Notification No. 42-Dir(A-II)/2-(5/6)/2020-II dated 10th December, 2020, Mr. Umair Ali, a BS-18 PA&AS Officer, has relinquished the charge as Assistant Accountant General in O/o the Accountant General Pakistan Revenues, Islamabad on 11th December, 2020 and assumed the charge of the

Dy. Controller in O/o. the Controller Military Accounts (Rawalpindi Command) Rawalpindi on the same date.

No. 709/PAAS-II/39-2020.—Consequent upon promotion to the post of Deputy Director/equivalent (BS-18) on regular basis vide O/o. Auditor General of Pakistan Islamabad's Notification No. 42/Dir(A)II/CA-II/1-5/P-18/2020 dated 10th December, 2020 and posting/transfer vide Notification No. 42-Dir(A-II)/2-(5/6)/2020-II dated 10th December, 2020, Ms. Fatima Hameed, a BS-18 PA&AS Officer, has relinquished the charge as Deputy Director (OPS), in O/o the Directorate General Audit, Social Safety Nets, Regional Office Lahore on 14th December, 2020 and assumed the charge of the same post (BS-18) on regular basis, on the same date.

No. 710/PAAS-II/43-2020.—Consequent upon promotion to the post of Deputy Director/equivalent (BS-18) on regular basis vide O/o. Auditor General of Pakistan Islamabad's Notification No. 42/Dir(A)II/CA-II/1-5/P-18/2020 dated 10th December, 2020 and posting/transfer vide Notification No. 42-Dir(A-II)/2-(5/6)/2020-II dated 10th December, 2020, Mr. Amir Nisar, a BS-18 PA&AS Officer, has relinquished the charge as Assistant Accountant General in O/o the Accountant General Pakistan Revenues, Islamabad on 23rd December, 2020 and assumed the charge of the post of Dy. Chief Accounts Officer (Budget), Pakistan Post Office Department, Islamabad on the same date.

Islamabad, the 29th December, 2020

No. 367/PAAS-I/19-2009(756).—Mr. Mahmood Ahmad Khan, a BS-19 officer of Pakistan Audit & Accounts Service on his repatriation from Benazir Income Support Programme (BISP), Islamabad has joined office of the Auditor General of Pakistan, Islamabad on 17th December, 2020, in pursuance of of Auditor General of Pakistan office Notification No. 62-Dir/(A)/2-4/2020 dated 17th December, 2020.

No. 368/PAAS-I/17-2010(839).—Mr. Amjad Ali Gill, a BS-19 officer of Pakistan Audit & Accounts Service, has relinquished charge of the post of Director (Establishment), in office of the Auditor General of Pakistan, Islamabad on 14th December, 2020 and assumed charge of the post of Director, Budget & Accounts, Pak PWD, Islamabad on same date, in pursuance of of Auditor-General of Pakistan office Notification No. 61-Dir/(A)/2-4/2020 dated 9th December, 2020.

No. 711/PAAS-II/40-2020.—Consequent upon promotion to the post of Deputy Director/equivalent (BS-18) on regular basis vide O/o. Auditor General of Pakistan Islamabad's Notification No. 42/Dir(A)VCA-II/1-5/P-18/2020 dated 10th December, 2020 and posting/transfer vide Notification No. 42-Dir(A-II)/2-(5/6)/2020-II dated 10th December, 2020, Ms. Aiman Latif Bhatti, a BS-18 PA&AS Officer, has relinquished the charge as Deputy Director (OPS), in O/o the Director General Audit, Local Councils, Sindh, Karachi on 11th December, 2020 and assumed the charge of the same post (BS-18) on regular basis, on the same date.

No. 712/PAAS-II/41-2020.—Consequent upon promotion to the post of Deputy Director/equivalent (BS-18) on regular basis vide O/o. Auditor General of Pakistan Islamabad's Notification No. 42/Dir(A)VCA-II/1-5/P-18/2020 dated 10th December, 2020 and posting/transfer vide Notification No. 42-Dir(A-II)/2-(5/6)/2020-II dated 10th December, 2020, Ms. Uzma Salim, a BS-18 PA&AS Officer, has relinquished

the charge as Deputy Director (OPS), in O/o the Director General, Commercial Audit & Evaluation (South) Karachi on 11th December, 2020 and assumed the charge of the same post (BS-18) on regular basis, on the same date.

Islamabad, the 31st December, 2020

No. 715/PAAS-II/27-2020.—Consequent upon promotion to the post of Deputy Director/equivalent (BS-18) on regular basis *vide* Notification No. 42/Dir(A)/CA-II/1-5/P-18/2020 dated 10th December, 2020 and posting/transfer *vide* Office of the Auditor General of Pakistan Islamabad's Notification No. 42/Dir(A)CA-II/1-5/P-18/2020 dated 10th December, 2020, Ms. Zubda Mubashar, has relinquished the charge of the post of Deputy Director (OPS), O/o the Director General Audit, Khyber Pakhtunkhwa, Peshawar on 18th December, 2020 and assumed the charge of the post of Deputy Director (BS-18) in the O/o Director General Audit Water Resources Lahore on 21st December, 2020 (19th & 20th December, 2020 being Saturday & Sunday respectively).

No. 717/PAAS-II/37-2020.—Consequent upon promotion to the post of Deputy Director/equivalent (BS-18) on regular basis *vide* O/o Auditor General of Pakistan Islamabad's Notification No. 42/Dir(A)CA-II/1-5/P-18/2020 dated 10th December, 2020 and posting/transfer *vide* Notification No. 42-Dir(A-II)/2-(5/6)/2020-II dated 10th December, 2020, Mr. Sahib Dino, a BS-18 PA&AS Officer, has relinquished the charge as Deputy Director (OPS), in O/o the Director Audit, Petroleum & Natural Resources, Karachi on 10th December, 2020 and assumed the charge of the same post (BS-18) on regular basis, on the same date.

NADIA USMAN,
Assistant Auditor General (PAAS).

Islamabad, the 31st December, 2020

No. 951/Estt-C/01-2016-II.—Mr. Jamil Ahmed, Audit Officer (BS-18), office of the Director General, Commercial Audit & Evaluation, Wah Cantt has expired on 17th November, 2020 (May his soul rest in peace).

His name is therefore accordingly struck off the strength from the department with effect from 17th November, 2020.

MUHAMMAD IMRAN SARWAR,
Audit Officer (Establishment).

[OFFICE OF THE CONTROLLER GENERAL OF ACCOUNTS]

Islamabad, the 28th December, 2020

No. 924/CGA/Admn/36-1/2020(54).—In pursuance of Section-13 of Civil Servants Act, 1973, Mr. Ahmed Naveed Khan, Accounts Officer (BS-18), of office of the DG Accounts Works, Lahore on attaining the age of superannuation shall stand retired from Government Service with effect from 2nd December, 2021 (His date of birth 2nd December, 1961).

No. 922/CGA/Admn/38-1/2020(14).—In pursuance of Section-13 of Civil Servants Act, 1973, Mr. Ejaz Ahmed Khan, Accounts Officer (BS-18), of office of the Chief Accounts Officer Pakistan Post Office Department,

Islamabad on attaining the age of superannuation shall stand retired from Government Service with effect from 22nd July, 2021 (His date of birth 22nd July, 1961).

No. 926/CGA/Admn/34-2/2020(04).—In pursuance of Section-13 of Civil Servants Act, 1973, Mr. Muhammad Akram, Assistant Accounts Officer (BS-17), of office of the Pakistan Post Office Department, Lahore on attaining the age of superannuation shall stand retired from Government Service with effect from 2nd February, 2021 (His date of birth 2nd February, 1961).

No. 928/CGA/Admn/29-1/2020(77).—In pursuance of Section-13 of Civil Servants Act, 1973, Mr. Muhammad Mumtaz Khan, Assistant Accounts Officer (BS-17), of office of the AG KP, Peshawar shall stand retired from Government Service with effect from 9th April, 2021 (His date of birth 9th April, 1961).

Islamabad, the 30th December, 2020

No. 942/CGA/Admn/21-1/2020(47).—In pursuance of Section-13 of Civil Servants Act, 1973, Mr. Khadim Hussain, Accounts Officer (BS-18), O/o the Accountant General Pakistan Revenues, Islamabad, shall stand retired from Government Service with effect from 30th November, 2021 after attaining the age of superannuation, being his date of birth as 30th November, 1961.

No. 937/CGA/Admn/29-2/2020(42).—In pursuance of Section-13 of Civil Servants Act, 1973, Syed Aftab Ahmad, Assistant Accounts Officer (BS-17), of office of the Accountant General Khyber Pakhtunkhwa, Peshawar, on attaining the age of superannuation shall stand retired from Government Service with effect from 20th February, 2021 (His date of birth 20th February, 1961).

Islamabad, the 31st December, 2020

No. 945/CGA/Admn-I/01-125/2016.—In pursuance of this office Notification No. 532/CGA/PAAS/1-3/2017 dated 14th December, 2020, Mr. Moin Iqbal has relinquished the charge of the post of Assistant Controller General of Accounts (Legal) (BS-18) in this office on 24th December, 2020.

No. 944/CGA/Admn/28-2/2020(56).—In pursuance of Section-13 of Civil Servants Act, 1973, Mr. Muhammad Hanif, Divisional Accounts Officer (BS-17), of office of the Accountant General Sindh, Karachi, on premature retirement basis shall stand retired from Government Service with effect from 1st January, 2022 (his date of birth 14th October, 1962).

No. 947/CGA/Admn-I/03-130/2020.—In pursuance of this office Notification No. 895/CGA/Estt/PT/Cadreed-posts/AAO/2020 dated 27th November, 2020, Mr. Ghulam Abbas, Assistant Accounts Officer (BS-17) of office of the DBA Pak PWD, Islamabad has assumed the charge of his post in this office with effect from 24th December, 2020 on temporary transfer basis.

No. 950/CGA/Admn-I/17-33/2002 Vol-I.—On the recommendation of Departmental Promotion Committee the Deputy Controller General of Accounts (Admin) has been pleased to promote the following Junior Auditors (BS-11) as Senior Auditor (BS-16) with effect from 16th December, 2020.

S. No.	Name	Designation	Remarks
01	Muhammad Salman	Senior Auditor	Against 15% quota
02	Muhammad Arshad	Senior Auditor	Against 35% quota
03	Fazal e Rabi	Senior Auditor	Against 35% quota
04	Ilyas Khan	Senior Auditor	Against 15% quota
05	Muhammad Qadeer	Senior Auditor	Against 35% quota

JIBRAN KHAN DURRANI,
Assistant Controller General of Accounts (Admn).

Islamabad, the 31st December, 2020

No. 1004/CGA/Estt/11-C/SA/2013.—The Deputy Controller General of Accounts is pleased to order the temporary transfer of Mr. Asif Raza, Senior Auditor (BPS-16) from office of the Director General of Accounts Works, Lahore to office of the Accountant General Punjab, Lahore, till further orders.

ROIDAR ALI,
Accounts Officer (Establishment).

[OFFICE OF THE ACCOUNTANT GENERAL PAKISTAN REVENUES]

Islamabad, the 29th December, 2020

No. Admn-I/PF-AAO/602/IH/154.—Consequent upon his repatriation from National Highways and Motorways Police, Islamabad vide Notification No. NHMP-4 (2)/2012 413 dated 23rd June, 2020, CGA Office Notification No. 434/CGA/Promotion/77/PF/SA to AAO/2020 and this office Notification No. Admn-1/2-7/DPC/SR to AAO/2019-20/92 even dated 22nd October, 2020, Mr. Ikhlas Hussain has assumed the charge of the post of Assistant Accounts Officer (BS-17) in Office of Accountant General Pakistan Revenues with effect from 15th December, 2020. He is posted in CC-I & II Section.

Authority: Accountant General Pakistan Revenues Orders dated 28th December, 2020.

MUHAMMAD AKRAM AWAN,
Accounts Officer (Admn-I).

ELECTION COMMISSION OF PAKISTAN

Islamabad, the 2nd January, 2021

No. F. 4(5)/2016-Estt-I.—Mr. Sajid Ali, a BS-19 officer of Election Commission of Pakistan, presently posted as Director in this Secretariat, is granted 19 days Quarantine

Leave from 30th November to 18th December, 2020 alongwith prefix & suffix closed holidays falling on 28th & 29th November and 19th & 20th December, 2020 respectively.

On the expiry of leave, the above officer has assumed the charge of his post at Islamabad.

This has approval of the Secretary, Election Commission.

IMRAN ZAFAR,
Deputy Director (Estt-I).

Islamabad, the 1st January, 2021

No. F. 4(16)/2013-Estt-I.—Syed Amjad Hussain, Assistant Director in this Commission's Secretariat, Islamabad is granted 11 days leave on full pay with effect from 29th December, 2020 to 8th January, 2021 with permission to suffix closed holidays falling on 9th & 10th January, 2021.

On expiry of leave, Syed Amjad Hussain is likely to assume the charge of same post at the same station.

BASIL AKRAM,
Deputy Director (Estt-II).

[OFFICE OF THE PROVINCIAL ELECTION COMMISSIONER
BALOCHISTAN]

Quetta, the 1st January, 2021

No. F. 3(431)/2020-Estt.—In pursuance of this office notification of even number dated the 16th December, 2020, Mr. Abdul Qadir, Director (MIS) relinquished the charge of his post from office of the Provincial Election Commissioner, Balochistan, Quetta on 11th December, 2020 and assumed the charge of his post in office of the Provincial Election Commissioner, Balochistan, Quetta on 28th December, 2020 (F.N) after availing 11-days leave on full pay with effect from 14th December, 2020 to 24th December, 2020 alongwith suffix closed holidays falling on 25th, 26th & 27th December, 2020.

MUHAMMAD YAQOOB RIND,
Deputy Director.

MINISTRY OF ENERGY

(Petroleum Division)

Islamabad, the 16th November, 2020

No. GSP-2(13)/2012-Vol-III.—Consequent upon their nomination made by Federal Public Service Commission (FPSC) and having been declared medically fit by the Central Medical Board, the following Assistant Directors (Geology) (BS-17) are appointed in Geological Survey of Pakistan, Ministry of Energy (Petroleum Division):-

They will be on probation for a period of one year in terms of Rule-21 of the Civil Servants (Appointment, Promotion and Transfer) Rules, 1973.

S. No.	Name	Joining Date
1.	Malik Muhammad Usman	12-10-2020
2.	Mr. Muhammad Kamran Jafri	22-10-2020
3.	Mr. Muhammad Attique Amer	26-10-2020

SHAHBAZ KHAN,
Section Officer (Mineral).

Islamabad, the 18th November, 2020

No. 4(94)/2015-Admn—With the approval of competent authority, Ms. Hina Batool Gardezi, Section Officer (D-IV)/ (BS-18) of this Division is granted 14 days leave on full pay (LFP) with effect from 9th November, 2020 to 22nd November, 2020 on medical grounds.

2. Mr. Waqar Zulfiqar Ahmed Asif, Section Officer (D-I)/ BS-18 of this Division will look after the work of Section Officer (D-IV) during her leave.

3. The officer is likely to resume for duty on the same post and station after expiry of the said leave.

4. This issues with the approval of the Secretary (Petroleum Division).

Islamabad, the 26th November, 2020

No. 2(11)/2010-Admn—Pursuant to Finance Division's (Regulations Wing) O.M. No. F. 2(1)R-3/2007, dated 8th August, 2019, Mr. Yasir Bashir, Assistant Private Secretary (BS-16) posted with Additional Secretary (BS-21) of this Division is granted Special Pay @ Rs. 1,000/- p.m. with effect from 6th April, 2020.

This issues with the approval of Joint Secretary (A&CA).

Islamabad, the 27th November, 2020

No. 3(2)/2006-Admn—The competent authority has been pleased to allow Mr. Faisal Bashir, Network/System, Administrator (BS-18) of this Division to hold additional charge of the post of Accounts Officer in addition to his own duties for a period of ninety (90) days with effect from 19th November, 2020 to 16th February, 2021 or till the availability of a regular incumbent whichever is earlier. The officer will work as DDO in Petroleum Division.

This issues with the approval of Secretary (Petroleum Division).

Islamabad, the 8th December, 2020

No. 1(1)/2006-Admn—Pursuant to Establishment Division's Notification No. 8/2/2020-E-VII, dated 20th November, 2020, Mr. Umer Saeed has relinquished the charge of the post of Section Officer (OMG/BS-17) in Petroleum Division with effect from 20th November, 2020.

No. 1(1)/2006-Admn—Pursuant to Establishment Division's Notification No. 8/2/2020-E-VII, dated 20th November, 2020, Mr. Umer Saeed has assumed the charge of the post of Section Officer (OMG/BS-18) on Acting Charge basis in Petroleum Division with effect from 20th November, 2020.

No. 1(1)/2006-Admn—Pursuant to Establishment Division's Notification No. 8/2/2020-E-VII, dated 20th November, 2020, Mr. Muhammad Omar Farooq Mahar has relinquished the charge of the post of Section Officer (OMG/BS-17) in Petroleum Division with effect from 20th November, 2020.

No. 1(1)/2006-Admn—Pursuant to Establishment Division's Notification No. 8/2/2020-E-VII, dated 20th November, 2020, Mr. Muhammad Omar Farooq Mahar has assumed the charge of the post of Section Officer (OMG/BS-18) on Acting Charge basis in Petroleum Division with effect from 20th November, 2020.

MUHAMMAD BILAL KHAN,
Section Officer (Admn).

[POLICY WING]

Islamabad, the 4th January, 2021

No. 3(137)/2015-Oil/Deppt.—Mr. Khushnaam Ali Khan, currently posted as Assistant Director (Data Base)/BS-17, Policy Wing, Petroleum Division, Ministry of Energy is assigned additional charge of the post of Assistant Director (Non-Technical)/ BS-17 with effect from 5th January, 2021 in addition to his own duties for a period of ninety (90) days or till availability of regular incumbent, whichever is earlier.

This issues with the approval of Secretary, Petroleum Division, Ministry of Energy.

IMRAN SALEEM,
Deputy Director (Admn).

Islamabad, the 1st January, 2021

No. 3(56)/91-Oil.—After availing 12 days L.F.P with effect from 7th December, 2020 to 18th December, 2020, Mr. Iltaf Hussain Ansari, Director (L&M) /BS-19, Directorate General (Oil), Policy Wing, Petroleum Division, Ministry of Energy has assumed charge of the post of Director (L&M)/BS-19, Directorate General (Oil), Policy Wing, Petroleum Division, Ministry of Energy on 21st December, 2020 (*i.e.* first working day after leave)

No. PW/Admn-2(3)/2019.—Mr. Imran Saleem, currently posted as Deputy Director (Non-Technical)/BS-18 Directorate General (Gas), Policy Wing, Petroleum Division, Ministry of Energy is assigned additional charge of the post of Deputy Director (Non-Technical/Admin)/BS-18 with effect from 1st January, 2021 in addition to his own duties for a period of ninety (90) days or till availability of regular incumbent, whichever is earlier.

This issues with the approval of Secretary, Petroleum Division, Ministry of Energy.

KHUSHNAAM ALI KHAN,
Assistant Director (Admin).

MINISTRY OF FEDERAL EDUCATION AND
PROFESSIONAL TRAINING

Islamabad, the 4th January, 2021

No. F. 5-204/2018/MC/FDE.—On having been found guilty of “Misconduct” under rule 3 (b) of Government Servants (Efficiency & Discipline) Rules 1973, due to charge of unauthorized absence from Government duty with effect from 1st January, 2009 as contained in the charge sheet bearing No. F. 9-202/2019/MC/FDE dated 20th February, 2020 & Show Cause Notice dated 14th December, 2020 along with inquiry report dated 27th August, 2020 and on the recommendation of Authorized Officer in terms of rule 5 (1) (iv) *ibid*, the competent authority *i.e.* Secretary, Ministry of Federal Education & Professional Training, Islamabad has imposed the major penalty *i.e.* “Removal from Service” under Section 4 (b) (iii) of Government Servants (Efficiency and Discipline) Rules 1973 on Mr. Nasir Ahmed, Lecturer (BS-17), Islamabad College for Boys (ICB), G-6/3, Islamabad under Federal Directorate of Education with immediate effect and recovery of payment overdrawn during the period of absence, if any from his payable dues *i.e.* G.P. Fund.

2. He can make an appeal/representation against award of major penalty to the appellate authority next above the authority through proper channel within 30-days from the date of issuance of this notification.

MUHAMMAD ZULFIQAR JATOI,
Section Officer (Colleges).

MINISTRY OF FINANCE, REVENUE AND ECONOMIC
AFFAIRS

(Finance Division)

[HRM WING]

Islamabad, the 4th December, 2020

No. F. 1-168/94-HR-II.—On his repatriation from Embassy of Pakistan, China, Beijing, *vide* its Notification No. MEB/9-1/HR/2020, dated 23rd October, 2020, Mr. Zulfiqar Ali Shah, Assistant Private Secretary (BS-16) has been taken on the roll of Finance Division with effect from 2nd November, 2020 after availing joining time as admissible under the rules.

Islamabad, the 30th December, 2020

No. F. 1-294/2013-HR-II.—Mr. Muhammad Arshad, Assistant Private Secretary (BS-16), Finance Division, Islamabad, shall stand retired from Government Service on attaining the age of superannuation on 9th April, 2021 (according to his date of birth 10th April, 1961).

No. F. 1-400/83-HR-II.—Syed Farrukh Sear, Superintendent (BS-17), Finance Division, Islamabad, shall stand retired from Government Service on attaining the age of superannuation on 14th February, 2021 (according to his date of birth 15th February, 1961).

No. F. 1-292/2012-HR-II.—Mr. Saqib Rashid, Assistant Private Secretary (BS-16), Finance Division, Islamabad,

shall stand retired from Government Service on attaining the age of superannuation on 24th March, 2021 (according to his date of birth 25th March, 1961).

MARIYA FARHEEN,
Section Officer (HR-II).

Islamabad, the 30th December, 2020

No. F. 7(57)/HR-IV/2018.—Mr. Muhammad Saeed Ahmed Khan, Accounts Officer/Deputy Director (BS-18) of Office of the Auditor General of Pakistan, after attaining the age of superannuation has retired from the Government Service with effect from 26th December, 2020 *vide* office of the Auditor General of Pakistan Office Order No. 673/ PAAS-II/19-2020 dated 8th December, 2020.

On retirement he has relinquished the charge of the post of Accounts Officer/Deputy Director (BS-18) in Finance Division on 24th December, 2020 (25th December, 2020 & 26th December, 2020 being holidays).

MUHAMMAD HAYAT,
Section Officer (HR-IV).

(Economic Affairs Division)

Islamabad, the 1st January, 2021

No. 1(1280)/EA/A-I/2013.—Mr. Abdul Wakeel, Superintendent (BS-17), is assigned with effect from 21st December, 2020, current charge of the higher post of Section Officer (IsDB-I) (BS-17/18), Economic Affairs Division for a period of three months (90 days) or till the availability of regular incumbent of the post whichever is earlier. As per rules, he will be entitled to draw “Special Pay” equal to 20% of basic pay subject to a maximum of Rs. 12,000/-p.m whichever is less.

This issues with the approval of Secretary, Economic Affairs Division.

No. 1-1392/EA/A1/2017.—In pursuance of this Division’s Notification No. 7(4)/EA/Admin-I/2020 dated 30th December, 2020, Mr. Mukhtar Ahmed, has relinquished charge of the post of Superintendent (BS-16) and assumed charge of the post of Superintendent (BS-17) in Economic Affairs Division with effect from 18th December, 2020.

SAJID HUSSAIN ABBASI,
Section Officer (Admin-I).

MINISTRY OF HOUSING AND WORKS

Islamabad, the 30th December, 2020

No. F. 5(2)/2010-Admn-III.—With approval of competent authority *i.e.* Secretary, Ministry of Housing & Works, the services of Mr. Muhammad Arslan Adil Choudhary, Exexecutive Engineer (Civil) (BS-18), Central Civil Circle-II, Pak. PWD, Islamabad are placed at the disposal of M/o. Inter Provincial Coordination for further

posting in Pakistan Sports Board on deputation basis on standard terms and conditions with immediate effect.

SYED ZEESHAN RAZA ZAIDI,
Section Officer (Admn-III).

MINISTRY OF HUMAN RIGHTS

Islamabad, the 1st January, 2021

No. F. 2(15)/2019-Admn.—Mr. Waqar Hussain Abbasi, Deputy Secretary (B&C) of this Ministry is granted additional charge of the post of Deputy Secretary (Admin) for a period of three months with effect from 1st January, 2021 or till the availability of regular incumbent whichever is earlier. While relieving Mr. Waheed Ullah Khan of the current charge of the post of Deputy Secretary (Admin).

This issues with the approval of Secretary, Ministry of Human Rights, Islamabad.

No. F. 2(15)/2019-Admn.—Mr. Muhammad Yousaf Shah, Director, NCPC is granted additional charge for the post of Director, Social Welfare of this Ministry for a period of three months with effect from 1st January, 2021 or till the availability of regular incumbent whichever is earlier.

This issues with the approval of Secretary, Ministry of Human Rights, Islamabad.

MARYAM ASLAM,
Section Officer (Admn).

Islamabad, the 1st January, 2021

No. PF. 12(BA)/SW.—Mr. Bilal Ahmad, Deputy Director (BS-18) Social Welfare Training Institute (SWTI) under the administrative control Ministry of Human Rights, shall stand retired from Government Service with effect from 11th October, 2020 on attaining the age of superannuation.

BABAR ALI,
Deputy Director (SW).

MINISTRY OF INFORMATION TECHNOLOGY &
TELECOMMUNICATION

Islamabad, the 1st January, 2021

No. F. 1-2/2020-IT.—Consequent upon his contract appointment as Manager (Infrastructure) in PPS-8 under the Project titled. "Project Monitoring and Digital Transformation Cell" Mr. Rizwan Ahmed has joined his duties with effect from 1st January, 2021 with same terms and conditions as laid down in the original offer letter.

NASEEM A. KHAN ABBASI,
Deputy Secretary (Dev).

MINISTRY OF INTERIOR

Islamabad, the 4th January, 2021

No. 5/29/2020-Admn-I.—In pursuance of the Establishment Division's Notification No. PF (688)/E-5 (PAS),

dated 21st December, 2020, Mr. Iftikhar Ali Shalwani, a BS-21 officer of Pakistan Administrative Service has assumed the charge of the post of Additional Secretary (BS-21), Interior Division on 21st December, 2020.

No. 5/27/2020-Admn-I.—Ms. Sadia Haider, (BS-18/PAS), Ministry of Interior has been granted ninety (90) days maternity leave with full pay from 18th December, 2020 to 17th March, 2021.

On expiry of the leave, the officer is expected to resume her duty on the same post and place on due date.

This issues with the approval of the Secretary Interior.

ABDUL RAZAQ,
Section Officer (Admn-I).

MINISTRY OF INTER PROVINCIAL COORDINATION

Islamabad, the 1st January, 2021

No. F. 1-3/2018-Admn (NIP).—With the approval of Secretary, Ministry of IPC, Mr. Abdul Hamid Baloch, Deputy Secretary (CCI) is allowed to hold additional charge of the post of Director (BS-19), National Internship Program under Ministry of Inter Provincial Coordination in addition to his own duties for a period of 03 months (90-days) with immediate effect or till the availability of regular incumbent, whichever is earlier. He will be entitled to draw additional remuneration as admissible under the rules.

No. F. 1-3/2018-Admn (NIP).—With the approval of Secretary, Ministry of IPC, Ms. Iqra Khan, Section Officer (IPC) is allowed to hold current charge of the post of Deputy Director (Admn) (BS-18), National Internship Program under Ministry of Inter Provincial Coordination in addition to her own duties for a period of 03 months (90-days) with immediate effect or till the availability of regular incumbent, whichever is earlier. She will be entitled to draw additional remuneration as admissible under the rules.

FARHAN AKHTAR,
Section Officer (Admn-I).

MINISTRY OF LAW AND JUSTICE

Islamabad, the 4th January, 2021

No. F. 24(15)/1997-A-III (pt).—In pursuance of this Ministry's notification of even number dated 2nd December, 2020, Mr. Arshad Mahmood, District and Sessions Judge has assumed the charge of the post of Judge, Banking Court-I, Faisalabad with effect from 14th December, 2020. He is also authorized to exercise DDO Powers of the said Court.

No. F. 24(18)/1997-A-III (pt).—Pursuant to this Division Notification No. F. 24(15)/1997-A-III (Pt) dated 2nd December, 2020 Mr. Muhammad Ashiq, District and Sessions Judge has assumed the charge of the post of Judge, Banking Court-II, Lahore with effect from 9th December, 2020. He is also authorized to exercise DDO powers of the said Court.

MUHAMMAD RAZAULLAH LAKHO,
Section Officer (A-III).

Islamabad, the 1st January, 2021

No. F. 2(4)/2017-A.V.—In pursuance of this Division's notification of even number dated 4th December, 2020, Raja Qamar-uz-Zaman, District and Sessions Judge has assumed the charge of the post of Judge, Special Court (Central), Faisalabad on 14th December, 2020.

He is also entrusted the powers of Drawing and Disbursing Officer (DDO), Special Court (Central), Faisalabad with immediate effect and until further orders.

Islamabad, the 4th January, 2021

No. F. 28(14)/2015-A.V.—Mr. Nasir Majeed, Private Secretary (BS-17), Insurance Tribunal, Lahore is hereby transfer/posted on attachment basis in Special Court (Central-I), Lahore with immediate effect and until further orders.

Further, this Division's office order dated 5th September, 2019 regarding transferred/posting of Mr. Nasir Majeed, Private Secretary (BS-17), in Special Court (Central-II), Lahore on attachment basis is hereby withdrawn.

This issues with the approval of the Secretary, Law & Justice Division.

No. F. 3(15)/2015-A.V (pt).—With the approval of the competent authority, Mr. Nazakat Ali Bhand, Registrar (BS-17), Accountability Court-II, Karachi is hereby entrusted the powers of Drawing Disbursing Officer (DDO), Accountability Court-III, Karachi with immediate effect.

FAISAL MALIK,
Section Officer (A-V).

MINISTRY OF NATIONAL FOOD SECURITY AND
RESEARCH

Islamabad, the 4th January, 2021

No. F. 9-4/2019-NFS&R/EW.—In pursuance of Cabinet decision *vide* Case No. 1047/51/2020 dated 29th December, 2020 the following Committee is hereby notified to work out the contours and modalities for Agriculture Package:-

- a. Minister for Economic Affairs (Convener)
- b. Minister for Foreign Affairs
- c. Minister for Inter-Provincial Coordination
- d. Minister for States & Frontier Regions
- e. SAPM on Parliamentary Coordination
- f. SAPM on Political Affairs
- g. Secretary Finance Division

h. Secretary Ministry of National Food Security & Research.

2. The National Food Security and Research Division will provide Secretariat support to the Committee.

QASIM KHAN KHATTAK,
Deputy Secretary (Admn).

MINISTRY OF NATIONAL HEALTH SERVICES,
REGULATIONS & COORDINATION

Islamabad, the 1st January, 2021

No. F. 3-92/2016-T-I.—With the approval of competent authority *i.e.* Secretary NHS,R&C, Dr. Fauzia Nawaz, Medical Officer (BS-17), Health Department, Government of KPK, presently posted as Medical Officer (BS-17) in PIMS on deputation *vide* Notification No. PF-3-92/2016-H-I dated 16th September, 2019 is transferred and posted in National Institute of Rehabilitation Medicines (NIRM) Islamabad for the remaining period of deputation on the same terms and conditions with immediate effect.

ZAFAR IQBAL,
Deputy Secretary (Tech-I).

Islamabad, the 31st December, 2020

No. PF. 10(23)SH/2018-Admn-I.—In supersession of this Ministry's Notification No. 11-7/2019-FMDC(E-IV) dated 21st July, 2020, the Notification No. 11-7/2019-FMDC(E-IV) dated 3rd March, 2020 regarding transfer of Mr. Shoaib Hasan, Section Officer (BS-17), M/o. NHSR&C against the post of Deputy Director (BS-18) in Federal Medical & Dental College Islamabad, on deputation basis under Section 10 of Civil Servants Act 1973, has been withdrawn/cancelled with immediate effect.

Islamabad, the 4th January, 2021

No. F. 3-4/2020-Admn-III.—With the approval of competent authority *i.e.* Secretary NHS,R&C, Dr. Aziz Bangash, Assistant Director (BS-17), PIMS is transferred and posted as Deputy Director (Technical) (BS-18) in Coordination/Common to Manage Global Fund under Section 10 of Civil Servants Act, 1973 with immediate effect and until further orders.

No. F. 5-1/2020-(Admn-I).—The competent authority *i.e.* Secretary, Ministry of National Health Services, Regulations and Coordination (NHSR&C) is pleased to place the services of Mr. Majid Khan, Assistant Director (BS-17), Human Organ Transplant Authority (HOTA) at the disposal of Ministry of National Health Services, Regulations and Coordination, Islamabad as Assistant Director (BS-17) on deputation basis for a period of three years on standard terms and conditions with immediate effect.

FARHAN SIKANDAR,
Section Officer (Admn-I).

Islamabad, the 4th January, 2021

No. 1-39/2018/FMDC(H-III).—With the approval of competent authority, Dr. Saima Saleem, Demonstrator

(BS-17), Federal Medical College had been granted 730 days study leave and she has availed 695 days and her remaining period of leave *i.e.* 35 days with effect from 3rd December, 2020 to 6th January, 2021 has been cancelled.

IMRAN ALI,
Section Officer (T-IV).

Islamabad, the 1st January, 2021

No. F. 3-49/2015-T-II.—With the approval of competent authority, Dr. Muhammad Umer Shahzad, Medical Officer (BS-17), Federal Government Polyclinic, Islamabad is granted one month *ex-Pakistan* leave with effect from 4th January, 2021.

This Ministry has no objection on his proceeding abroad during the subject leave.

No. F. 10-35/2018-SO(Admn-II)(DHO).—In pursuance of Services & General Administration Department, Government of the Punjab Notification dated 16th December, 2020, Ms. Riffat Ambreen, Charge Nurse (BS-16), Syed Muhammad Hussain Trust TRB Hospital, Samli Sanatorium, Murree, Government of Punjab is transferred and posted in District Health Office, ICT on deputation basis for a period of three years on standard terms and conditions with immediate effect.

Islamabad, the 4th January, 2021

No. F. 1-166/2018-T-II (FGPC).—With the approval of competent authority *i.e.* Secretary, Ministry of National Health Services, Regulations and Coordination, Dr. Syed Rohaan Ahsan Bukhari, Medical Officer (BS17), Federal Government Polyclinic (FGPC), Islamabad is granted 04 years study leave (*ex-Pakistan*), (02 years on half average pay and remaining next 02 years as extra ordinary leave without pay) to visit United Kingdom (UK) to upgrade his qualification in the field of Psychiatry as under:-

- (i) 02 years leave on half average pay with effect from 4th January, 2021 to 3rd January, 2023.
- (ii) 02 years extraordinary leave (without pay) with effect from 4th January, 2023 to 3rd January, 2025.

2. On expiry of the above leave period, he will report on the same post in FGPC.

3. This Ministry has no objection on his proceeding abroad during the above leave.

SYED HASSAN MEHMOOD,
Section Officer (T-II).

MINISTRY OF NARCOTICS CONTROL

Islamabad, the 4th January, 2021

No. 3-108/2020-Admn.—In pursuance of Establishment Division's Notification No. PF. 922/2009-E-VII dated 16th December, 2020, Ms. Affaf Faiz Rasool Malik, Section Officer (OMG/BS-18) has assumed the charge of the post

of Section Officer (BS-18) on regular basis, in Ministry of Narcotics Control, Islamabad with effect from 1st January, 2021.

This issues with the approval of the Secretary, Ministry of Narcotics Control.

JAMAL TAYYAB,
Deputy Secretary (Admn).

Islamabad, the 1st December, 2020

No. 3-90/2019-Admn.—In pursuance of Establishment Division's Notification No. PF. 4/56/2011-E-VII dated 16th July, 2019, Ms. Tahira Sadozai, a BS-17, Section Officer has relinquished the charge of the post of Section Officer (BS-17) in Ministry of Narcotics Control, Islamabad on 19th November, 2020.

This issues with the approval of the Sr. Joint Secretary, MNC.

SYED SAADAT ALI BOKHARI,
Section Officer (Admn).

Islamabad, the 4th January, 2021

No. 4-4/98-ANF.—In partial modification of Ministry of Narcotics Control, Islamabad's Notification No. 4-4/98-ANF dated 12th June, 2002, notification of even number dated 31st July, 2007, 5th August, 2008 and 2nd November, 2011, in exercise of the powers conferred by Sub Section (9) of Section 6 of the Anti Narcotics Force, Act 1997, the Secretary, Ministry of Narcotics Control has approved relocation of ANF PS Multan and Mianwali to the following new locations with the same areas of jurisdiction with immediate effect:

Police Station	Old Location	New Location
PS ANF Multan	House No. 3-T Garden Town, Cantt Board Multan.	Subhan Manzal, New Garden Town, Khairpur Bhutta, Multan Cantt
PS ANF Mianwali	House No. 352, Talangang Road, Kot Ahmad Khan, Mianwali	House No. M-131-B Near Markez Eid Gah, Balo Khel, Mianwali

MUHAMMAD HASSAN ABDULLAH,
Section Officer (ANF).

MINISTRY OF OVERSEAS PAKISTANIS & HUMAN
RESOURCE DEVELOPMENT

Islamabad, the 4th January, 2021

No. F. 1(3)/2019-CWA-I.—Consequent upon his selection for posting as Community Welfare Attache, Consulate General of Pakistan, Jeddah (KSA), Mr. Saqib Ali Khan, a BS-18 officer of Office Management Group, has assumed charge of the post of Community Welfare

Attache in the Mission on 17th November, 2020, with diplomatic status of First Secretary.

MINISTRY OF PLANNING, DEVELOPMENT &
SPECIAL INITIATIVES

2. The intervening period is regularized as under:-

Islamabad, the 10th December, 2020

i.	Relinquished charge from Ministry of OP&HRD	09-11-2020 (AN)
ii.	Transit (Islamabad-Jeddah)	10-11-2020
iii.	Six days joining time spent at Jeddah	11-11-2020 to 16-11-2020
iv.	Assumed charge in the Mission	17-11-2020 (FN)

No. 12(06)EG/HRM.II/PD/2020.—On the recommendation of FPSC on 1st September, 2020 and subsequent approval of the Prime Minister of Pakistan, Mr. Muhammad Ali Kemal is appointed as Chief (BS-20) in the Economist Group, Ministry of Planning Development & Special Initiatives.

2. After having been relieved as Research Economist from Pakistan Institute of Development Economics (PIDE), Mr. Ali Kemal has assumed charge of the post of Chief (BS-20), Economists Group, Ministry of Planning, Development & Special Initiatives on 7th December, 2020.

3. He will be on probation for a period of one year with effect from 7th December, 2020, extendable by an order either before or after its termination by a further period not exceeding one year.

INAM ULLAH KHAN,
Deputy Secretary (HRM-I).

2. The intervening period is regularized as under:-

i.	Relinquished charge from Board of Investment	02-11-2020
ii.	Transit (Islamabad-Riyadh)	03-11-2020
iii.	Six days joining time spent at Riyadh	04-11-2020 to 09-11-2020
iv.	Assumed charge in the Embassy	10-11-2020

Islamabad, the 3rd November, 2020

No. 9(19)EG/HRM.II/PD/05.—Ms. Fozia Aftab, Assistant Chief (BS-18), M/o. Planning, Development & Special Initiatives is granted 15 days leave on full pay with effect from 2nd November, 2020 to 16th November, 2020 on medical grounds, subject to title under the Revised Leave Rules, 1980.

She is likely to resume charge of her post in this Ministry after expiry of the above leave.

Islamabad, the 20th November, 2020

No. F. 1(4)/2020-CWA-I.—Consequent upon selection for posting as Community Welfare Attache, Embassy of Pakistan, Riyadh (KSA), Mr. Naveed Afzaal, a BS-18 officer of Defence Intelligence Services, has assumed charge of the post of Community Welfare Attache in the Embassy on 10th November, 2020, with diplomatic status as Second Secretary.

No. 9(75)EG/HRM.II/PD/2017.—On expiry of fifteen (15) days leave on full pay, Mr. Shahid Imdad, a BS-17 officer of the Economists Group posted as Section Officer (Admn-VII), has resumed charge of his post in this Ministry on 17th November, 2020.

Islamabad, the 24th November, 2020

2. The intervening period is regularized as under:-

i.	Relinquished charge from Board of Investment	02-11-2020
ii.	Transit (Islamabad-Riyadh)	03-11-2020
iii.	Six days joining time spent at Riyadh	04-11-2020 to 09-11-2020
iv.	Assumed charge in the Embassy	10-11-2020

No. 7(7)EG/HRM.II/PD/2011.—On expiry of fifteen (15) days leave on full pay on medical grounds, Ms. Mahjabeen Cheema, Assistant Chief (BS-18), Economists Group has resumed charge of her post in this Ministry on 23rd November, 2020.

Islamabad, the 2nd December, 2020

No. 9(19)EG/HRM.II/PD/2005.—On expiry of fifteen (15) days leave on full pay with effect from 2nd November, 2020 to 16th November, 2020 on medical grounds, Ms. Fozia Aftab, Assistant Chief (BS-18), Economists Group has resumed charge of her post in this Ministry on 16th November, 2020.

Islamabad, the 10th December, 2020

No. 7(19)EG/HRM.II/PD/11.—Ms. Hina Afzal, Assistant Chief (BS-18), M/o. Planning, Development & Special Initiatives has been allowed fifteen (15) days Rest & Recreation

JUNAID AFZAL,
Section Officer.

(R&R) from 10th December, 2020 to 24th December, 2020, subject to title under the Revised Leave Rules, 1980.

She is likely to resume charge of her post in this Ministry after expiry of the above leave.

No. 9(79)EG/HRM.II/PD/2018.—Mr. Muhammad Zaman, Research Officer (BS-17), M/o. Planning, Development & Special Initiatives is granted 15 days leave on full pay with effect from 14th December, 2020 to 28th December, 2020, subject to title under the Revised Leave Rules, 1980.

He is likely to resume charge of his post in this Ministry after expiry of the above leave.

Islamabad, the 28th December, 2020

No. 10(43)EG/HRM.II/PD/2012.—Mr. Shahid Zia Cheema, Chief (BS-20), M/o. Planning, Development & Special Initiatives is granted 37 days leave on full pay with effect from 17th November, 2020 to 7th December, 2020 and 10th December, 2020 to 25th December, 2020 on medical grounds, subject to title under the Revised Leave Rules, 1980.

He is likely to resume charge of his post in this Ministry after expiry of the above leave.

No. 9(27)EG/HRM.II/PD/2010.—On expiry of thirty (30) days leave on full pay with effect from 18th November, 2020 to 17th December, 2020, Dr. Hanan Ishaque, Assistant Chief (BS-18), Economists Group has resumed charge of his post in this Ministry on 17th December, 2020.

Islamabad, the 30th December, 2020

No. 9(78)EG/HRM.II/PD/2017.—On expiry of ninety (90) days leave on half pay with effect from 23rd September, 2020 to 21st December, 2020, Mr. Asadullah Qureshi, Research Officer (BS-17), Economists Group has resumed charge of his post in this Ministry on 22nd December, 2020.

Islamabad, the 4th January, 2021

No. 9(58)EG/HRM.II/PD/2017.—Mr. Ijlal Haider, Research Officer (BS-17), M/o. Planning, Development & Special Initiatives is granted 45 days leave on full pay with effect from 16th January, 2021 to 1st March, 2021, subject to title under the Revised Leave Rules, 1980.

He is likely to resume charge of his post in this Ministry after expiry of the above leave.

SEHRISH GHAYAS,
Section Officer (HRM-II).

MINISTRY OF PRIVATISATION

[PRIVATISATION COMMISSION]

Islamabad, the 4th January, 2021

No. F. 1(1)Admn/PC/2021.—In pursuance of Establishment Division's Notification No. F. 11/01/2019-E, dated 17th December, 2020, Mr. Imran Jamil Shami, a BS-19 officer of Secretariat Group, has assumed the charge of the post of the Director General (PC-20), Privatisation

Commission, Ministry of Privatisation, Islamabad under Section 10 of Civil Servants Act, 1973 with effect from 1st January, 2021.

KHALID MEHMOOD,
Section Officer (Admin).

MINISTRY OF RAILWAYS

[RAILWAY BOARD]

Islamabad, the 11th December, 2020

No. 2/10/2019-A-II.—In pursuance of Establishment Division Notification No. 1/66/2020-E-6 dated 24th November, 2020, the competent authority has been pleased to appoint Mr. Jamshed Inam Sheikh as Advisor (Human Resource Development & Capacity Building) in Pakistan Railways in MP-I Scale on contract basis for a period of three (03) years with effect from 1st December, 2020.

WAQAR AHMED,
Deputy Director/Admn-II.

MINISTRY OF SCIENCE & TECHNOLOGY

Islamabad, the 1st January, 2021

No. F. 1(2)/2020-Org (Pt-II).—In pursuance of the Establishment Division's Notification No. 1/43/2019-E-6 dated 28th December, 2020, Dr. Shahid Mahmood Baig has assumed the charge for the post of Chairman (MP-I) Scale, Pakistan Science Foundation under Administrative control of Ministry of Science & Technology, Islamabad on contract basis for a period of three (03) years with effect from December 28, 2020 on the terms and conditions of Management Position Scales Policy of Federal Government dated 22nd June, 2020.

MUHAMMAD HANIF AWAN,
Deputy Secretary (Org).

NATIONAL ASSEMBLY SECRETARIAT

Islamabad, the 22nd February, 2021

No. G(569)/Estt.I-(54).—In continuation of this Secretariat's Notification No. G(569)/Estt.I(8), dated 27th January, 2021, Ms. Ghazala Gohar Abro, Assistant Director (Translation) (BS-17) in the National Assembly Secretariat is granted extension in leave for 07 days on full pay with effect from 13th February, 2019 with permission to suffix Saturday & Sunday, the 20th & 21st February, 2021 to her leave.

On expiry of the above leave, she has resumed her duty on 22nd February, 2021.

No. G(462)/Estt.I-(55).—Syed Nasir Abbas Gillani, Section Officer (BS-17), is granted 12 days leave on full pay (LFP) with effect from 1st March, 2021 with permission to prefix closed holidays of 27th & 28th February, 2021 and suffix closed holidays of 13th & 14th March, 2021 to his leave.

On expiry of the above leave, he is expected to resume charge of the same post at Islamabad on 15th March, 2021.

SHEHRYAR KHAN,
Section Officer.

SENATE SECRETARIAT

Islamabad, the 22nd February, 2021

No. F. 3(14)/2018-HRM (14).—In supersession of this Secretariat's earlier Notification No. F. 3(14)/2018-HRM (13) dated 17th February, 2021, the competent authority has been pleased to appoint Mr. Hussain Islam as Advisor to the Chairman Senate Secretariat, Islamabad without remuneration/pro-bono in BPS-22 for a period of three years, under Rule 7(I)(d) of the Senate Secretariat (Service) Rules, 2017, with immediate effect and until further orders.

This issues with the approval of Chairman Senate.

ASIM KHAN GORAYA,
Joint Secretary (HRM).

Islamabad, the 17th February, 2021

No. G (212)/2013-HRM (12).—In pursuance of the Pakistan Institute for Parliamentary Services, Islamabad, Letter No. 3(1)/Deputation-2021/PIPS(I) dated the 16th February, 2021, the competent authority has been pleased to place the services of Mr. Salman Ayub Khakwani, Assistant Director (BPS-17), Senate Secretariat, Islamabad, at the disposal of Pakistan Institute for Parliamentary Services, Islamabad, on deputation basis against the post of Assistant Director (Capacity Building) (OG-V).

He is relieved of his duties in the Senate Secretariat, Islamabad, with immediate effect and until further orders.

This issues with the approval of the competent authority.

Islamabad, the 18th February, 2021

No. G(239)/2017-HRM (12).—Mr. Sami Ullah, Assistant Director (BPS-17), Senate Secretariat, Islamabad, is granted, subject to title, 19 days leave on full pay with effect from 8th February, 2021 with permission to prefix Saturday and Sunday falling on 6th & 7th February, 2021, and to suffix Saturday and Sunday falling on 27th & 28th February, 2021, respectively, to the leave.

After expiry of the leave, He is likely to resume duty of the same post on 1st March, 2021 at Islamabad.

Islamabad, the 22nd February, 2021

No. F. 3 (3)/2020-HRM-I (15).—In pursuance of Establishment Division, Islamabad Notification No. 1/167/2020-E-4, dated the 4th February, 2021, Mr. Safwan Ullah Khan, Assistant Auditor General (Personnel) (BPS-18), Office of the Auditor General of Pakistan is appointed as Deputy Secretary (BPS-19) on deputation basis, on standard terms and conditions, in the Senate Secretariat, Islamabad, with effect from 17th February, 2021.

He will be entitled to draw deputation allowance @ 20% of his basic pay, subject to a maximum of Rs. 12,000/- per month.

This issues with the approval of Chairman Senate.

ZAHOOR AHMED,
Section Officer (HRM-I).

Islamabad, the 16th February, 2021

No. F. 3 (2)/2020-HRM (15).—The competent authority has been pleased to appoint of Mr. Shah Jehan S/o. Niaz Hussain, against the post of Assistant Protocol Officer (BPS-16) on contract basis, without advertisement under Rule-17 of Senate Secretariat (Service) Rules, 2017 for a period of 06 weeks *i.e.* 10th February, 2021.

The other terms and conditions of his appointment will be the same as conveyed to him *vide* the Senate Secretariat's Letter No. F. 3(2)/2020-HRM, dated the 3rd December, 2020.

This issues with the approval of Chairman Senate.

Islamabad, the 17th February, 2021

No. PA (48)/2017-HRM (15).—The competent authority has been pleased to accept the resignation of Mr. Shahbaz Saleem, Assistant Private Secretary (BPS-16), Senate Secretariat, Islamabad, with immediate effect.

This issues with the approval of Chairman Senate.

SADIA AMIR,
Section Officer (HRM-II).

SUPREME COURT OF PAKISTAN

Islamabad, the 19th February, 2021

No. F. 24/649/2004-SCA.—Mr. Abid Hussain Awan, Senior Court Associate (BS-19) of this Court is granted nine (09) days' LFP with effect from 8th February, 2021 to 16th February, 2021 (both days inclusive), on account of private affairs, subject to verification of title of his leave account by the AGPR, Islamabad.

No. F. 24/912/2019-SCA.—Mr. Ahmed Nadeem Khan, Research Officer (BS-19) of this Court is granted six (06) days' LFP with effect from 15th February, 2021 to 20th February, 2021 (both days inclusive), on account of private affairs, subject to verification of title of his leave account by the AGPR, Islamabad.

No. F. 24/869/2016-SCA.—Mr. Shahid Qamar, Assistant Librarian (BS-16) of this Court is granted eight (08) days' LFP with effect from 6th March, 2021 to 13th March, 2021 (both days inclusive), on account of private affairs, subject to verification of title of his leave account by the AGPR, Islamabad.

PERVAIZ IQBAL,
Assistant Registrar (Admn).

The Gazette of Pakistan

PUBLISHED BY AUTHORITY

KARACHI, WEDNESDAY, APRIL 14, 2021

PART II

Notifications issued by Ministry of Defence and Ministry of Defence Production

Karachi, the 14th April, 2021

MINISTRY OF DEFENCE

(Defence Division)

No. 251/2021 :

The following officer granted Direct Short Service Commission, with effect from 18th October, 15 with antedate seniority, with effect from 18th May, 15 is further granted an antedate seniority for two years on account of higher qualification (MS/M. Phile in Business Administration) *vide* Corrigendum No. 9/74 to AI 147/59 from the date shown against their name which will count for seniority, promotion and increment *vide* Corrigendum No. 2/95 to AI 147/59, but will not entiteld them to any back pay on this account *vide* AR(R) 229.

S. No.	No. Rank & Name	w.e.f.
a.	PSS-56259 Capt. Khurshid Ahmed, AEC	18th May, 2013

[No. 4/6/D-2(A-II)/2021].

No. 252/2021 :

Following officers of Pakistan Air Force are promoted to the substantive rank of Sqn. Ldr. with effect from dates as mentioned against their names, declared suitable and medically fit by the AHQ, Islamabad.

S. No.	Particulars of Officers	w.e.f.
1.	Flt. Lt. Mateen Asghar Pak/15782 Engg.	23rd November, 2020
2.	Flt. Lt. Temur Khurram Pak/15783 Engg.	23rd November, 2020

S. No.	Particulars of Officers	w.e.f.
3.	Flt. Lt. Muhammad Ahmad Usman Pak/15784 Engg.	23rd November, 2020
4.	Flt. Lt. Waqas Haider Pak/15789 Engg.	23rd November, 2020
5.	Flt. Lt. Yasir Arafat Pak/15793 Edu.	23rd November, 2020
6.	Flt. Lt. Muhammad Abdullah Farooq Javed Pak/15795 Edu.	23rd November, 2020
7.	Flt. Lt. Ali Raza Bajwa Pak/15799 Edu.	23rd November, 2020
8.	Flt. Lt. Nasir Shahzad Pak/14912 Log.	16th December, 2020
9.	Flt. Lt. Usman Javed Pak/14915 Log.	16th December, 2020
10.	Flt. Lt. Fargam Hussain Pak/14918 Log.	16th December, 2020
11.	Flt. Lt. Salman Ghafoor Bhatti Pak14919 Log.	16th December, 2020

[No. 12357/23/Mng/PB/02/D-10(AF-II)/2021].

No. 253/2021 :

Following officers of Pakistan Air Force are promoted to the substantive rank of Sqn. Ldr. with effect from dates as mentioned against their names, declared suitable and medically fit by the AHQ, Islamabad.

S. No.	Particulars of Officers	w.e.f.
1.	Flt. Lt. Qurat Ul Ain Pak/14526 Med.	8th April, 2017
2.	Flt. Lt. Zulfiqar Ali Pak/15294 Med.	26th May, 2018
3.	Flt. Lt. Nasrin Ali Pak/18059 Med.	1st April, 2020
4.	Flt. Lt. Qaisar Iqbal Pak/15998 Med.	20th May, 2020
5.	Flt. Lt. Rizwana Nasreen Pak/18231 Med.	30th September, 2020
6.	Flt. Lt. Muhammad Mansoor Iqbal Pak/18234 Med.	30th September, 2020
7.	Flt. Lt. Memoona Kokab Pak/18399 Med.	5th November, 2020

[No. 12357/23/Mng/PB/03/D-10(AF-II)/2021].

No. 254/2021 :

Following officers of Pakistan Air Force are promoted to the substantive rank of Sqn. Ldr. with effect from dates as mentioned against their names, declared suitable and medically fit by the AHQ, Islamabad.

S. No.	Particulars of Officers	w.e.f.
1.	Flt. Lt. Sohail Ahmad Pak/14276 Engg.	8th December, 2017
2.	Flt. Lt. Muhammad Arsalan Malik Pak/15597 GD (P).	19th November, 2019
3.	Flt. Lt. Saad Ali Pak/14352 A&SD.	25th March, 2020
4.	Flt. Lt. Rizwan Shafique Pak/14631 IT.	13th September, 2020

[No. 12357/23/Mng/PB/04/D-10(AF-II)/2021].

No. 255/2021 :

Following officers of Pakistan Air Force are promoted to the substantive rank of Sqn. Ldr. with effect from 21st November, 2020, declared suitable and medically fit by the AHQ, Islamabad.

S. No.	Particulars of Officers
1.	Flt. Lt. Moazzam Parvez Malik Pak/14768 A&SD.
2.	Flt. Lt. Qamar Ul Islam Pak/14780 A&SD.
3.	Flt. Lt. Furqan Sadiq Pak/14846 Engg.
4.	Flt. Lt. Syed Muhammad Tashfeen Javad Pak/14850 Engg.
5.	Flt. Lt. Jamil Hussain Pak/14852 Engg.
6.	Flt. Lt. Surkhab Gill Pak/14854 Engg.
7.	Flt. Lt. Saad Bin Abbas Pak/14872 AD.
8.	Flt. Lt. Muhamamd Adeel Akhtar Pak/14889 A&SD.
9.	Flt. Lt. Muhammad Kamran Nazeer Pak/14890 A&SD.
10.	Flt. Lt. Muhammad Hamid Rafique Pak/14891 A&SD.
11.	Flt. Lt. Muhammad Shahid Khalid Pak/14892 A&SD.
12.	Flt. Lt. Muhammad Iqbal Pak/14896 A&SD.
13.	Flt. Lt. Aamir Ali Pak/14897 A&SD.

[No. 12357/23/Mng/PB/05/D-10(AF-II)/2021].

No. 256/2021 :

Following officers of Pakistan Air Force are promoted to the substantive rank of Sqn. Ldr. with effect from dates as mentioned against their names, declared suitable and medically fit by the AHQ, Islamabad.

S. No.	Particulars of Officers	w.e.f.
1.	Flt. Lt. Bilal Javed Kazi Pak/15590 GD (P).	19th November, 2019
2.	Flt. Lt. Fatima Ali Pak/15603 GD (P).	19th November, 2019

S. No.	Particulars of Officers	w.e.f.
3.	Flt. Lt. Muhammad Usama Pak/14325 AD.	25th March, 2020
4.	Flt. Lt. Muhammad Azfar Zafar Pak/14339.	25th March, 2020
5.	Flt. Lt. Nadeem Anwer Nadeem Pak/14406 A&SD.	30th March, 2020
6.	Flt. Lt. Waheed Hussain Shah Pak/14410 A&SD.	30th March, 2020
7.	Flt. Lt. Mujahid Khan Lodhi Pak/14608 Log.	13th September, 2020

[No. 12357/23/Mng/PB/06/D-10(AF-II)/2021].

No. 257/2021 :

Following officers of Pakistan Air Force are promoted to the substantive rank of Flt. Lt. with effect from dates as mentioned against their names, declared suitable and medically fit by the AHQ, Islamabad.

S. No.	Particulars of Officers	w.e.f.
1.	Flg. Off. Mujtaba Haider Naqvi Pak/17330 GD (N).	4th April, 2018
2.	Flg. Off. Shaheer Rabbani Pak/17561 GD (P).	25th September, 2018
3.	Flg. Off. Taimoor Hassan Khan Pak/16827 Engg.	25th October, 2018
4.	Flg. Off. Mehran Ameer Pak/16833 Engg.	25th October, 2018
5.	Flg. Off. Muhammad Jamal Zahoor Pak/16837 Engg.	25th October, 2018

[No. 12357/23/Mng/PB/07/D-10(AF-II)/2021].

No. 258/2021 :

Following officers of Pakistan Air Force are promoted to the substantive rank of Flt. Lt. with effect from dates as mentioned against their names, declared suitable and medically fit by the AHQ, Islamabad.

S. No.	Particulars of Officers	w.e.f.
1.	Flg. Off. Umair Ahmed Khan Pak/18232 Med.	13th September, 2013
2.	Flg. Off. Fakiha Zabit Pak/18753 Med.	8th March, 2015

S. No.	Particulars of Officers	w.e.f.
3.	Flg. Off. Hina Batool Siddiqui Pak/18754 Med.	8th March, 2015
4.	Flg. Off. Asma Ul Haq Pak/18062 Med.	1st April, 2020
5.	Flg. Off. Namra Tauqir Pak/18064 Med.	1st April, 2020
6.	Flg. Off. Aamina Javaid Pak/18066 Med.	1st April, 2020
7.	Flg. Off. Hina Sohail Pak/18067 Med.	1st April, 2020
8.	Flg. Off. Sundas Zafar Pak/18235 Med.	30th September, 2020
9.	Flg. Off. Ammara Suleman Pak/18236 Med.	30th September, 2020
10.	Flg. Off. Hafiza Maryam Masood Pak/18237 Med.	30th September, 2020
11.	Flg. Off. Sarah Ayub Pak/18243 Med.	30th September, 2020
12.	Flg. Off. Zainab Hayat Pak/18244 Dental.	30th September, 2020
13.	Flg. Off. Sajida Bibi Pak/18245 Med.	30th September, 2020

[No. 12357/23/Mng/PB/08/D-10(AF-II)/2021].

No. 259/2021 :

Following officers of Pakistan Air Force are promoted to the substantive rank of Flt. Lt. with effect from dates as mentioned against their names, declared suitable and medically fit by the AHQ, Islamabad.

S. No.	Particulars of Officers	w.e.f.
1.	Flg. Off. Nadia Erum Pak/18415 Med.	30th March, 2014
2.	Flg. Off. Sajila Bano Pak/18420 Med.	30th March, 2014
3.	Flg. Off. Nusrat Khatoon Pak/18421 Med.	30th March, 2014
4.	Flg. Off. Rabia Asghar Pak/18752 Med.	8th March, 2015
5.	Flg. Off. Tahira Sadiq Pak/18755 Med.	8th March, 2015
6.	Flg. Off. Rakhshanda Aslam Pak/18756 Med.	8th March, 2015

S. No.	Particulars of Officers	w.e.f.
7.	Flg. Off. Tanveer Khan Pak/18757 Med.	8th March, 2015
8.	Flg. Off. Sobia Leghari Pak/17727 Med.	12th April, 2018
9.	Flg. Off. Aqsa Hameed Pak/17992 Med.	24th April, 2019
10.	Flg. Off. Rabeea Zeb Ijaz Pak/18239 Dental.	30th September, 2020
11.	Flg. Off. Mashaal Zahid Pak/18241 Dental.	30th September, 2020
12.	Flg. Off. Zain Younis Pak/18242 Med.	30th September, 2020
13.	Flg. Off. Muniba Ilyas Pak/18400 Med.	5th November, 2020

[No. 12357/23/Mng/PB/09/D-10(AF-II)/2021].

No. 260/2021 :

Following officers of Pakistan Air Force are promoted to the substantive rank of Flt. Lt. with effect from dates as mentioned against their names, declared suitable and medically fit by the AHQ, Islamabad.

S. No.	Particulars of Officers	w.e.f.
1.	Flg. Off. Obaid Fayyaz Pak/17795 Engg.	28th October, 2017
2.	Flg. Off. Zofishan Abbas Pak/16436 Engg.	28th October, 2017
3.	Flg. Off. Syed Sulaiman Shah Pak/16442 Engg.	28th October, 2017
4.	Flg. Off. Muhammad Saifullah Khadim Pak/16445 Engg.	28th October, 2017
5.	Flg. Off. Muhammad Qaisar Shehzad Pak/16446 Engg.	28th October, 2017
6.	Flg. Off. Syed Hammad Raza Rizvi Pak/16623 Engg.	19th April, 2018
7.	Flg. Off. Muhammad Arsalan Pak/16646 Engg.	19th April, 2018
8.	Flg. Off. Aamir Junaid Afzal Pak/16809 Engg.	25th October, 2018

S. No.	Particulars of Officers	w.e.f.
9.	Flg. Off. Taufeeq Anwar Pak/16814 Engg.	25th October, 2018
10.	Flg. Off. Fahad Naseer Pak/16822 Engg.	25th October, 2018
11.	Flg. Off. Ahmad Qayyum Pak/16824 Engg	25th October, 2018

[No. 12357/23/Mng/PB/10/D-10(AF-II)/2021].

No. 261/2021 :

The following officers of Pakistan Air Force (on probation) are confirmed and promoted to the substantive rank of Flg. Off. with effect from dates as mentioned against each, declared suitable and medically fit by the AHQ, Islamabad.

S. No.	Particulars of Officers	w.e.f.
1.	Plt. Off. Syed Abdul Qudoos Shah Pak/18134 GD (N).	12th April, 2017
2.	Plt. Off. Syed Muhammad Hamza Pak/18616 Dental.	6th October, 2017
3.	Plt. Off. Adeel Haider Pak/17940 Engg.	7th October, 2017
4.	Plt. Off. Arsalan Javaid Pak/18745 Engg.	7th October, 2017
5.	Plt. Off. Sher Ali Jadoon Pak/18816 Log.	8th March, 2019

[No. 12357/23/Mng/PB/11/D-10(AF-II)/2021].

No. 262/2021 :

The following officers of Pakistan Air Force (on probation) are confirmed and promoted to the substantive rank of Flg. Off. with effect from dates as mentioned against each, declared suitable and medically fit by the AHQ, Islamabad.

S. No.	Particulars of Officers	w.e.f.
1.	Plt. Off. Abdullah Haroon Pak/17566 A&SD.	5th October, 2017
2.	Plt. Off. Malik Muhammad Aamir Shehzad Pak/17569 A&SD	7th October, 2017

[No. 12357/23/Mng/PB/12/D-10(AF-II)/2021].

No. 263/2021 :

The competent authority *i.e.* Secretary Defence has accepted the resignation of Army No. 8472236, Mr. Musharraf Wajahat, AXEN E&M in MES with immediate effect.

[No. F.1/21/D-3(A-III)/2020].

No. 264/2021 :

Mr. Khushdil Khan Malik, Principal (BS-20), Federal Government Educational Institutions (Cantt / Garrisons) setup was considered by the Time Scale Committee for grant of BS-21 (Time Scale) in its meeting held on 30th September, 2020, the recommendation of which was subsequently approved by the competent authority, and was deferred owing to the following reasons :-

- a. The case was considered in the light of Islamabad High Court judgement dated 8th March, 2018 in ICA No. 859 of 2013 which attained finality and clearly states that the Time Scale Formula is restricted to the Teaching Staff and can only be claimed after resuming duties in the Parent Department. As the officer remained posted outside his parent Department (*i.e.* FGEI) since 2011, he could not be granted the benefit under the Time Scale Formula particularly when he was also seeking his inuction in the Secretariat Group. The officer shall be entitled to be considered for the benefits of the higher pay scale under the Time Scale Formula after he is repatriated and rejoins his parent department. Therefore, the Competent Authority shall consider and process the case of the officer (respondent) for grant of Time Scale after his repatriation to the parent department.
- b. The Committee observed that since the petitioner remained outside the teaching cadre since 2011, the case is to be deferred till the repatriation / resumption of duty by the officer concerned in the Teaching staff of FGEI.

[No. 4/13/D-22/2011].

No. 265/2021 :

Mr. Saifullah Khalid (Late-2019) Principal (BS-18), Federal Government Educational Institutions (Cantts / Garrisons) setup is not recommended for grant of Time Scale Committee in its meeting held on 30th September, 2020 due to unsatisfactory service record.

[No. 4/13/D-22/2011].

No. 266/2021 :

Syeda Shaheen Afzal, Principal (BS-18), Federal Government Educational Institutions (Cantts / Garrisons) setup is granted Time Scale (BS-19), with effect from 26th December, 2019.

[No. 4/13/D-22/2011].

No. 267/2021 :

Mrs. Shazia Gulzar, Principal (BS-18), Federal Government Educational Institutions (Cantts / Garrisons) setup is granted Time Scale (BS-19), with effect from 18th January, 2019.

[No. 4/13/D-22/2011].

No. 268/2021 :

Mrs. Bushra Arif, Principal (BS-18), Federal Government Educational Institutions (Cantts / Garrisons) setup is granted Time Scale (BS-19), with effect from 24th July, 2020.

[No. 4/13/D-22/2011].

No. 269/2021 :

Miss Rozina Khuwaja, Principal (BS-18), Federal Government Educational Institutions (Cantts / Garrisons) setup is granted Time Scale (BS-19), with effect from 26th December, 2019.

[No. 4/13/D-22/2011].

No. 270/2021 :

Syeda Zohra Jabeen, Principal (BS-18), Federal Government Educational Institutions (Cantts / Garrisons) setup is granted Time Scale (BS-19), with effect from 14th March, 2020.

[No. 4/13/D-22/2011].

No. 271/2021 :

Mrs. Adeela Sattar, Principal (BS-18), Federal Government Educational Institutions (Cantts / Garrisons) setup is granted Time Scale (BS-19), with effect from 21st July, 2019.

[No. 4/13/D-22/2011].

No. 272/2021 :

Mrs. Fozia Naveed, Principal (BS-18), Federal Government Educational Institutions (Cantts / Garrisons) setup is granted Time Scale (BS-19), with effect from 1st June, 2018.

[No. 4/13/D-22/2011].

No. 273/2021 :

Mrs. Abida Khanum, Principal (BS-18), Federal Government Educational Institutions (Cantts / Garrisons) setup is granted Time Scale (BS-19), with effect from 24th May, 2018.

[No. 4/13/D-22/2011].

No. 274/2021 :

Mrs. Rukhsana Talib, Principal (BS-18), Federal Government Educational Institutions (Cantts / Garrisons) setup is granted Time Scale (BS-19), with effect from 31st May, 2018.

[No. 4/13/D-22/2011].

No. 275/2021 :

Miss Shaista Anjum, Principal (BS-18), Federal Government Educational Institutions (Cantts / Garrisons) setup is granted Time Scale (BS-19), with effect from 12th May, 2018

[No. 4/13/D-22/2011].

No. 276/2021 :

Mr. Inam ur Rehman, Principal (BS-18), Federal Government Educational Institutions (Cantts / Garrisons) setup is granted Time Scale (BS-19), with effect from 30th June, 2020.

[No. 4/13/D-22/2011].

No. 277/2021 :

Mr. Muhammad Sharif, Principal (BS-18), (Retired) Federal Government Educational Institutions (Cantts / Garrisons) setup is granted Time Scale (BS-19), with effect from 12th December, 2018.

[No. 4/13/D-22/2011].

No. 278/2021 :

Mr. Fazal Mannan, Principal (BS-18), Federal Government Educational Institutions (Cantts / Garrisons) setup is granted Time Scale (BS-19), with effect from 7th February, 2019.

[No. 4/13/D-22/2011].

No. 279/2021 :

Mr. Muhammad Ashraf, Principal (BS-18), Federal Government Educational Institutions (Cantts / Garrisons) setup is granted Time Scale (BS-19), with effect from 18th January, 2019.

[No. 4/13/D-22/2011].

No. 280/2021 :

Mr. Shuaib Ahmed, Principal (BS-18), Federal Government Educational Institutions (Cantts / Garrisons) setup is granted Time Scale (BS-19), with effect from 14th July, 2017.

[No. 4/13/D-22/2011].

No. 281/2021 :

Mr. Bakht Muhammad, Principal (BS-18), Federal Government Educational Institutions (Cantts / Garrisons) setup is granted Time Scale (BS-19), with effect from 18th May, 2018.

[No. 4/13/D-22/2011].

No. 282/2021 :

Mr. Tariq Ismail, Principal (BS-18), Federal Government Educational Institutions (Cantts / Garrisons) setup is granted Time Scale (BS-19), with effect from 17th May, 2018.

[No. 4/13/D-22/2011].

No. 283/2021 :

Mr. Ghulam Akbar, Principal (BS-18), Federal Government Educational Institutions (Cantts / Garrisons) setup is granted Time Scale (BS-19), with effect from 18th May, 2018.

[No. 4/13/D-22/2011].

No. 284/2021 :

Mr. Munir Ahmed, Principal (BS-18), Federal Government Educational Institutions (Cantts / Garrisons) setup is granted Time Scale (BS-19), with effect from 18th May, 2018.

[No. 4/13/D-22/2011].

No. 285/2021 :

Mr. Kamran Rasheed, Principal (BS-18), Federal Government Educational Institutions (Cantts / Garrisons) setup is granted Time Scale (BS-19) with effect from 30th March, 2018.

[No. 4/13/D-22/2011].

No. 286/2021 :

Mrs. Kishwar Iqbal, Principal (BS-18), Federal Government Educational Institutions (Cantts / Garrisons) setup is granted Time Scale (BS-19), with effect from 31st December, 2019.

[No. 4/13/D-22/2011].

MIAN MUHAMMAD HILAL HUSSAIN, *HI(M)*
Lt. Gen. (Retd.),
Secretary.

The Gazette of Pakistan

PUBLISHED BY AUTHORITY

KARACHI, WEDNESDAY, APRIL 14, 2021

PART III

Notifications issued by the High Courts, the Federal Public Service Commission and by the Attached and Subordinate Offices of the Government of Pakistan

AGRICULTURE POLICY INSTITUTE

to draw all pensionary benefits as permissible to him under the rules.

Islamabad, the 3rd December, 2020

AAMNA AMEEN,
Director (Admn/Finance).

No. F.9(3)/Estt/95.—The competent authority in Agriculture Policy Institute (API) has been pleased to grant look after charge to Mr. Muhammad Azeem Hakro, Deputy Chief (IT) BS-19 to the post of Director Coordination BS-19 in addition to his on duties with immediate effect and until further orders.

Islamabad, the 22nd January, 2021

No. F.9(2)/Estt/88.—The Secretary, M/o. National Food Security & Research has been pleased to grant current charge 2nd time to Mrs. Shagufta Tasleem, Research Officer (BS-17), API of the vacant post of Assistant Chief (BPS-18) for the period of three months with effect from 7th December, 2020 to 6th March, 2021.

This issues with the approval of DG, API.

TARIQ MAHMOOD RAJA,
Deputy Director (Admin).

CENTRAL DIRECTORATE OF NATIONAL SAVINGS

Islamabad, the 21st January, 2021

No. F.7(2)/Admn-II/C.C/2007-III.—In exercise of the powers delegated to the Head of the Department *vide* Establishment Division's O.M. No.1/21/76-AR-R-II, dated 18th June, 1980, Director General Central Directorate of National Savings (CDNS), Islamabad has been pleased to appoint Mr. Muhammad Iftikhar, Assistant Director, RDNS, Bahawalpur, as Joint Director (BS-19), RDNS, Bahawalpur, on current charge basis, with immediate effect, till his retirement on 22nd February, 2021 or appointment of Joint Director, on regular basis, whichever is earlier.

He will draw pay in his own scale as BS-18 Officer *plus* additional pay equal to 20% of his scale of pay subject to a maximum of Rs.12,000/- per month, in terms of FR-35 and provision to section 17 of the Civil Servants Act, 1973 read with Finance Division's O.M. No.F.1(2)Imp/2016-333 dated 1st July, 2016.

CHIEF COMMISSIONERATE FOR AFGHAN REFUGEES

Islamabad, the 26th January, 2020

No. 1(3)/Admn/CCAR/19.—Mr. Muhammad Ibrahim Khattak, Director General (Repatriation), Commissionerate for Afghan Refugees Khyber Pakhtunkhwa, on attaining the age of superannuation *i.e.* 60 years, shall stand retired from Government service with effect from 27th May, 2021 (His date of Birth is 28th May, 1961). He shall be entitled

No. F.7(2)/Admn-II/C.C/2007-III.—In exercise of the powers delegated to the Head of the Department *vide* Establishment Division's O.M. No.1/21/76-AR-R-II, dated 18th June, 1980, Director General Central Directorate of National Savings (CDNS), Islamabad has been pleased to appoint Mr. Ahmad Masood Mohsin, Assistant Director, RDNS, Lahore, as Joint Director (BS-19), RDNS, Lahore, on current charge basis, with immediate effect, till his retirement on 28th February, 2021 or appointment of Joint Director, on regular basis, whichever is earlier.

He will draw pay in his own scale as BS-18 Officer *plus* additional pay equal to 20% of his scale of pay subject to a maximum of Rs.12,000/- per month, in terms of FR-35 and provision to section 17 of the Civil Servants Act, 1973 read with Finance Division's O.M. No.F.1(2)Imp/2016-333 dated 1st July, 2016.

Islamabad, the 22nd January, 2021

No. F.1(558)/Admn-I/2013.—Mr. Muhammad Akram Tabbasam, National Savings Officer (Current Charge) (BS-17) Regional Directorate of National Savings, Bahawalpur has been retired from Government Service with effect from 6th December, 2020, on attaining the age of superannuation (being date of Birth as 7th December, 1960).

In terms of Section 18-A (I) of the Revised Leave Rules 1980, read with Finance Division's SRO No.70(KE)/2012 dated 29th August, 2012 and O.M. dated 28th January, 2013, the competent authority has approved request for 365 days leave encashment in lieu of LPR in respect of above named officer. Leave pay for the purpose of encashment of LPR shall be computed on the basis of pay and allowances reckonable towards pension as shown in his last pay certificate.

ASIM MUSHTAQ,
Assistant Director (HR).

Islamabad, the 8th January, 2021

No. F.26(1)/Admn-I/2019.—In exercise of the powers delegated to the Head of the Department *vide* Establishment Division's O.M. No.1/21/76-AR-R-II, dated 18th June, 1980, Director General, National Savings, has been pleased to appoint Mr. Muhammad Younas, Assistant National Savings Officer (BS-14), Regional Directorate of National Savings, Multan, against the vacant post of National Savings Officer (BS-17), on Current Charge basis, with immediate effect, till retirement on superannuation or posting of National Savings Officer on regular basis, whichever is earlier.

He will draw pay in his own scale as BS-14 officer *plus* additional pay equal to 20% of his scale of pay subject to a maximum of Rs.12000/- per month in terms of FR-35 and provision to section 17 of the Civil Servants Act, 1973 read with Finance Division's O.M. No.F.1(3)Imp/2017-500, dated 3rd July, 2017.

Islamabad, the 25th January, 2021

No. F.1(553)/Admn-I/2013.—Mr. Abdul Razzaq Bajwa, National Savings Officer (Current Charge) (BS-17) Regional Directorate of National Savings, Multan stand retired from Government Service with effect from 2nd February, 2021, on attaining the age of superannuation (being date of Birth as 3rd February, 1961).

In terms of Section 18-A(I) of the Revised Leave Rules 1980, read with Finance Division's SRO No.70(KE)/2012 dated 29th August, 2012 and O.M. dated 28th January, 2013, the competent authority has approved request for 365 days leave encashment in lieu of LPR in respect of above named officer. Leave pay for the purpose of encashment of LPR shall be computed on the basis of pay and allowances reckonable towards pension as shown in his last pay certificate.

SHAKEEL AHMED,
National Savings Officer (HR).

DEPARTMENT OF TOURIST SERVICES

Islamabad, the 27th January, 2021

No. DTS.4(27)/83.—Mr. Muhammad Azam, Inspector (BPS-16), Department of Tourist Services, Islamabad has been granted 17-days leave on full pay with effect from 16th December, 2020 to 1st January, 2021 on medical grounds.

After expiry of said leave the officer has assumed the charge of the same post and at the same station.

TARIQ MAHMOOD,
Admin & Accounts Officer.

DIRECTORATE GENERAL OF SPECIAL EDUCATION

Islamabad, the 22nd January, 2021

No. PF.1134(SS)/A.II.—Mrs. Subrina Saleemi, Senior Teacher (BPS-17), National Special Education Centre for Hearing Impaired Children, Islamabad, under the Directorate General of Special Education, is granted 43 days leave with effect from 20th October, 2020 to 1st December, 2020 on medical grounds subject to title.

On expiry of 43 days leave on medical grounds with effect from 20th October, 2020 to 1st December, 2020, the officer has assumed the charge of the same post and at the same station on 2nd December, 2020.

Islamabad, the 26th January, 2021

No. PF.220(HH)/A.II.—In pursuance to Ministry of Human Rights Islamabad's notification of even number dated 15th January, 2021, Mrs. Human Hilal, has relinquished the charge of the post of Deputy Director, (BPS-18) from National Institute of Special Education, Islamabad under the Directorate General of Special Education, Islamabad on 15th January, 2021.

DR. MUHAMMAD WASEEM AKHTAR,
Deputy Director (Admin).

DIRECTORATE GENERAL OF TRADE ORGANIZATION

Islamabad, the 25th January, 2021

No. F.5(1)/2017-Admn.—In pursuance of Ministry of Commerce Notification No.15(1)/2010-Admn-III/CTG dated 21st January, 2021, Ms. Asma Khattak, a BS-18 Officer of Commerce & Trade Group has relinquished the charge of the post of Deputy Director (BS-18) in the Directorate General of Trade Organizations, Ministry of Commerce, Islamabad with effect from 22nd January, 2021 are placed at the disposal of Intellectual Property Organization of Pakistan (IPO) as deputy Director on deputation basis.

IRSHAD AHMED,
Director (Admn).

 DIRECTORATE OF ELECTRONIC MEDIA
& PUBLICATIONS

Islamabad, the 30th November, 2020

No. 7-10/85-E.—Ms. Nayyer Sultana Kazmi, Assistant Director (A&D) (BPS-17), DEMP, is granted 26 days leave on full pay with effect from 2nd November, 2020 to 27th November, 2020.

After expiry of leave, the officer will assume the charge on the same post and station on due date.

This issues with the approval of Director General.

Islamabad, the 21st January, 2021

No. 7-23/2010-E.—Consequent upon attaining the age of superannuation Syed Qasim Zafar Hashmi, Assistant Private Secretary (BPS-16) in the Directorate of Electronic Media and Publications, Regional Office, Karachi shall stand retired from Government Service with effect from 1st March, 2022.

This issues with the approval of the Director General.

EHSAN ULLAH SHAHZAD,
Deputy Director (Admin).

 FEDERAL DIRECTORATE OF EDUCATION

Islamabad, the 25th January, 2021

No. F.1-89/15-VP(W)/FDE.—With immediate effect and until further orders Mrs. Tehmina Akhtar, Vice Principal (BS-18), Islamabad Model School for Girls, New Shakrial (FA) Islamabad is hereby transferred to Islamabad Model School for Girls (I-X) Jaba Tali (FA) Islamabad against a vacant post.

No. T.A.D.A will be claim in this connection.

This is issues with the approval of Director General, FDE.

GHULAM HASNAIN,
Superintendent Schools (Female).

—————
[MODEL COLLEGES WING]

Islamabad, the 21st January, 2021

No. F.2-199/2018/MC/FDE.—The competent authority *i.e.* Secretary, Ministry of Federal Education & Professional Training, Islamabad has been pleased to accept the resignation tendered by Ms. Shagufta Mehmood, Senior Teacher (BPS-17), Islamabad Model College for Boys, F-8/4, Islamabad with effect from 7th March, 2018. The intervening period with effect from 25th May, 2017 to 6th March, 2018 is hereby regularized as Extra Ordinary Leave (EOL) without pay.

Her overdrawn payment amounting to Rs.392,971/- will be adjusted from her payable dues (*i.e.* G.P. Fund Balance, etc).

Her name has, therefore, been struck off the strength of Islamabad Model College's set up.

PROF. M. AFTAB TARIQ,
Director (Model Colleges).

 FEDERAL GOVERNMENT POLYCLINIC

(Postgraduate Medical Institute)

Islamabad, the 21st January, 2021

No. FGPC-1/4435/06.—Mr. Mevo Khan, Charge Nurse (BS-16) of Federal Government Polyclinic, Islamabad was granted leave on full pay with effect from 7th December, 2020 to 31st December, 2020 (25 days). Now he has resumed duty on 1st January, 2021 after availing leave.

Islamabad, the 22nd January, 2021

No. PF.1/3996/03.—Dr. Nusrat Shaheen, Medical Officer (BS-18) Federal Government Polyclinic, Islamabad was granted 24 days leave on full pay on medical grounds with effect from 5th December, 2020 to 28th December, 2020.

After availing above leave, he has joined his duty in this Hospital with effect from 29th December, 2020.

Islamabad, the 26th January, 2021

No. PF.1/5420/18.—Dr. Abida Faiz Talpur, Medical Officer (BS-17) Federal Government Polyclinic, Islamabad

was granted 90 days Maternity leave (1st) on full pay with effect from 23rd October, 2020 to 20th January, 2021.

After availing above leave, she has joined her duty in this Hospital with effect from 21st January, 2021.

DR. FAROOQ AKHTAR,
Deputy Executive Director.

FEDERAL SERVICE TRIBUNAL

Islamabad, the 27th January, 2021

No. F.11(6)/87-FST.—On attaining the age of superannuation, Mr. Sajjad Akhtar, Reader (BS-16), Federal Service Tribunal, Islamabad shall stand retired from Government Service on 6th September, 2021.

MANSAB ALI,
Superintendent.

GENERAL HEADQUARTERS FGEI (C/G) DIRECTORATE

(IGT & E's Branch)

Rawalpindi, the 12th January, 2021

No. 04/PF-06/Gen-FGEI(CA).—Mrs. Samina Khalid, Assistant Professor (BPS-18) FG Postgraduate College for Women, Wah Cantt. is granted 28 days leave on full average pay on medical grounds with effect from 5th November, 2020 to 2nd December, 2020.

On expiry of above leave, she was expected to resume duty at Wah.

No. 04/PF-2016/10-Gen-FGEI(CA).—Mrs. Shazia Tasleem, Lecturer (BPS-17), FG Degree College Lahore Cantt. is granted maternity leave (Pre/post-confinement) for 54 days with effect from 6th September, 2020 to 29th October, 2020.

This is issued in supersession of this Dte's letter of even number dated 9th October, 2020.

No. 04/PF-1599/03-Gen-FGEI(CA).—Mrs. Saima Pervez, Asstt. Prof. (BPS-18), FG Sir Syed College, Rawalpindi is granted maternity leave (Pre-confinement) for 45 days with effect from 12th November, 2020 to 26th December, 2020.

No. 04/PF-1472/01-FGEI(CA).—Having exercised his option not to avail LPR on attaining the age of superannuation on 14th February, 2022 (AN) Dr. Khan Muhammad, Professor (BPS-20), FG Degree College for Men, Wah Cantt. is hereby granted Encashment of LPR for 365 days from 15th February, 2021 to 14th February, 2022 in accordance with Finance Division's O.M.F.1(ii)-IMP/83 dated 18th August, 1983 & SRO (I)/2012 dated 29th August, 2012.

Certified that 893 days leave on full pay stands at his credit as verified by the Audit Office.

On expiry of encashment period, he will stand retired from Government service and his name will be struck off the strength of the said institution with effect from 14th February, 2022 (AN).

No. 04/PF-288/15-Gen-FGEI(CA).—Mrs. Sadia Kanwal, Lecturer (BPS-17) FG Degree College for Women, Kharian Cantt. is granted maternity leave (Post-confinement) for 45 days with effect from 30th November, 2020 to 13th January, 2021.

MUHAMMAD GHAFFAR, *Lt. Col.*
For Director General.

Rawalpindi, the 11th January, 2021

No. 04/PF-107/77-FGEI(SA).—Having exercised the option not to avail LPR on attaining the age of superannuation *i.e.* 60 years on 31st December, 2020, Mrs. Shahida Khanum, SST, FG JAS Public School PMA Kakul Abbottabad Cantt. is hereby granted encashment in lieu of LPR for 314 days with effect from 24th February, 2020 to 2nd January, 2021 in accordance with Finance Division's O.M. No.F.1(7)R-4/2004 dated 29th August, 2012.

Certified that 314 days leave on full pay is due at her credit as verified by PAO.

She will stand retired from Government Service and her name will be struck off the strength of said school with effect from 2nd January, 2021 (AN).

No. 04/PF-3431/77-FGEI(SA).—Mrs. Khalida Parveen, TGT, FG Public Middle School Shami Lines Hyderabad Cantt. is hereby granted 44 days leave as under:-

- 31 days leave on full pay with effect from 7th November, 2019 to 7th December, 2019 as post-confinement maternity leave.
- 13 days leave as EOL without pay with effect from 8th December, 2019 to 20th December, 2019.

Rawalpindi, the 12th January, 2021

No. 04/PF-536/77-FGEI(SA).—Mrs. Masooma Shahzadi, SST, FG Public School (G) Attock is hereby granted 14 days leave as EOL w/o. pay with effect from 25th October, 2020 to 7th November, 2020 on medical grounds.

No. 04/PF-102/77-FGEI(SA).—Mrs. Madiha Maria Batool, SST, FG Public School No.3 (Girls) 2nd Shift Multan is hereby granted 90 days pre/post-confinement maternity leave on full pay with effect from 4th September, 2020 to 2nd December, 2020.

No. 04/PF-844/77-FGEI(SA).—Ms. Misbah Naz, VP, F.G Junior Public School No.1 Pano Aqil Cantt. is hereby granted 21 days leave on full pay with effect from 25th November, 2020 to 15th December, 2020 on private affairs.

No. 04/PF-277/77-FGEI(SA).—Mrs. Sumera Azim, SST, F.G Fazaia Public School 2nd Shift JC Nur Khan, is hereby granted 10 days leave on full pay with effect from 9th November, 2020 to 18th November, 2020 on private affairs.

No. 04/PF-284/77-FGEI(SA).—Mrs. Aliya Parveen, TGT, FG Public School CMT & SD Peshawar Rd. Rawalpindi Cantt. is hereby granted 45 days pre-confinement maternity leave on full pay with effect from 11th November, 2020 to 25th December, 2020.

On expiry of above leave, she will proceed on post-confinement maternity leave.

No. 04/PF-749/77-FGEI(SA).—Mrs. Arfana Nasir, TGT, FG Public School MH Rd. Rwp Cantt. is hereby granted special/ iddat leave on full pay for 130 x days with effect from 21st November, 2020 to 20th March, 2020.

On expiry of above leave, she is expected to resume her duty in the same school at Rawalpindi Cantt.

No. 04/PF-310/77-FGEI(SA).—Having exercised the option not to avail LPR on attaining the age of superannuation *i.e.* 60 years on 31st December, 2021 Mrs Nasreen Mansha, SST, FG Junior Public School Chitral Lines Lahore Cantt is hereby granted encashment in lieu of LPR for 353 days with effect from 13th January, 2021 to 31st December, 2021 in accordance with Finance Division's O.M. No F.1(7) R-4/2004 dated 29th August, 2012.

2. Certified that 353 x days leave on full pay is due at her credit as verified by PAO.

3. She will stand retire from Government Service and her name will be struck off the strength of said school with effect from 31st December, 2021 (AN).

No. 04/PF-513/77-FGEI(SA).—Mrs. Bushra, TGT, FG Public Middle School Drigh Rd. Karachi Cantt. is hereby granted 45 days post-confinement maternity leave on full pay with effect from 1st November, 2020 to 15th December, 2020.

No. 04/PF-431/77-FGEI(SA).—Mrs. Nomana Jabeen, TGT, FG Model Public School Wah Cantt. is hereby granted 45 days post-confinement maternity leave on full pay with effect from 2nd December, 2020 to 15th January, 2021.

No. 04/PF-267/77-FGEI(SA).—Mrs. Sobia Jahanzaib, SST, FG Sir Syed Public School (Boys) Rawalpindi Cantt. is hereby granted 44 days post-confinement maternity leave on full pay with effect from 26th October, 2020 to 8th December, 2020.

No. 04/PF-384/77-FGEI(SA).—Mrs. Shahida Jamil, SS, FG Higher Sec. School (G) COD Kala Jhelum is hereby granted 15 days leave on half pay with effect from 25th October, 2020 to 7th November, 2020 on medical grounds.

No. 04/PF-972/77-FGEI(SA).—Mrs. Zareena Rashid, SS, F.G Higher Sec. School (G) COD Kala Jhelum, is hereby granted 7 days leave on half pay with effect from 19th October, 2020 to 25th October, 2020 on medical grounds.

No. 04/PF-934/77-FGEI(SA).—Mrs. Samia Kanwal Hashmi, SSS, F.G Higher Sec. School (G) COD Kala Jhelum, is hereby granted 10 days leave on half pay with effect from 2nd November, 2020 to 11th November, 2020 on medical grounds.

SUNDAS GUL, *Maj.*
For Director General.

Rawalpindi, the 11th January, 2021

No. 04/PF-15/77-FGEI(M).—Consequent upon his death occurred on 4th August, 2020, the family of late Sibte-Hassan, *Ex-EST*, FG Public School No.2 (Boys) Sialkot Cantt. is hereby granted *lump sum* payment equal to leave for 128 days.

Certified that 128 days leave on full pay is due at his credit.

Rawalpindi, the 12th January, 2021

No. 04/PF-529/77-FGEI(M).—Mr. Imran Ghani, Principal, FG Public School Bagh Cantt. is hereby granted leave on full pay for 13 days from 12th December, 2020 to 24th December, 2020 on private affairs.

ALI RAZA SHAH, *Maj.*
For Director General.

GEOLOGICAL SURVEY OF PAKISTAN

Quetta, the 24th March, 2020

No. Estt-I-832/PF.—In exercise of the powers delegated *vide* Establishment Division O.M No.1/21/78-AR-I/E-II, dated 18th August, 1980, the Director General has been pleased to allow Mr. Muhammad Tahir Khan, Store Officer (BPS-16), Geological Survey of Pakistan, Quetta to hold the current charge appointment to the post of Assistant Director (Stores) (BPS-17), Part-I, Geological Survey of Pakistan, Quetta for a period of three months with immediate effect, in addition of his own post or till the

regular appointment/ promotion to the post is made, whichever is earlier. The officer will be entitled to draw special pay as admissible under the rules.

This issues with the approval of the Director General, GSP.

INAMULLAH,
Deputy Director (Headquarters).

Quetta, the 5th March, 2020

No. Estt-I-589/PF.—Mr. Muhammad Atif, Geophysicist, GSP, Quetta is granted 55 days on full pay with effect from 6th February, 2020 to 31st March, 2020, with the permission to leave the station (subject to title).

On expiry of the leave, the officer will assumed his duty on the same station and post.

Quetta, the 9th March, 2020

No. Estt-I-747/PF.—Consequent upon his transfer Geological Survey of Pakistan Headquarters Office Quetta to Geological Survey of Pakistan, Lahore on THQ basis, *vide* GSP, Headquarters office order of even number dated 23rd January, 2020. Mr. Muhammad Irfan Zubair, Deputy Director (BPS-18), has relinquished the charge of his post at GSP, Quetta on 18th February, 2020 and assumed the charge of his post at Geological Survey of Pakistan, Lahore on 20th February, 2020.

The officer will draw his salary from the Head of Account Part-1, GSP, Quetta.

No. Estt-I-792/PF.—Mr. Amjid Raza, Statistical Officer (Budget Section), Geological Survey of Pakistan, Quetta is granted 19 days leave on full pay from 3rd February, 2020 to 21st February, 2020, with the permission to leave the station (subject to title).

On expiry of the leave, the officer will assume his duty on the same post and station.

Quetta, the 12th March, 2020

No. Estt-I-839/PF.—Mr. Muhammad Fakhar ud Din, Assistant Director, Geological Survey of Pakistan, Quetta is granted 16 days leave on full pay from 27th February, 2020 to 13th March, 2020 subject to title.

On expiry of the leave, the officer will assume his duty on the same post and station.

Quetta, the 16th March, 2020

No. Estt-I-820/PF.—In continuation of this department notification of even number dated 21st February, 2020. Mr. Abid Hussain Farooqi, Electronic Officer (BPS-16),

Geological Survey of Pakistan, Quetta is granted 7 days extension in leave on full pay from 7th March, 2020 to 13th March, 2020, subject to title.

On expiry of the leave, the officer is likely to resumed his duty on the same post and station.

Quetta, the 19th March, 2020

No. Estt-I-592/PF.—Mr. Waseemuddin, Superintendent, Geological Survey of Pakistan, Quetta is granted 30 days leave on full pay from 11th March, 2020 to 9th April, 2020.

On expiry of the leave, the officer will assume his duty on the same post and station.

No. Estt-I-816/PF.—Consequent upon his transfer from Geological Survey of Pakistan Headquarters Office Quetta to Geological Survey of Pakistan, Lahore, *vide* GSP, Headquarters office order of even number dated 16th January, 2020. Hafiz Muhammad Zulfiqar Ali, Assistant Director (BPS-17), has relinquished the charge of his post at GSP, Quetta on 18th February, 2020 and assumed the charge of his post at Geological Survey of Pakistan, Lahore on 24th February, 2020 after availing usual joining time as per rules.

The officer will draw his salary from the Head of Account Part-1, GSP, Lahore.

ZAHID HUSSAIN KHAN,
Assistant Director (Admn).

HEADQUARTERS AIRPORTS SECURITY FORCE

Karachi, the 22nd January, 2021

No. 51-1009/2017/FS-4/F.—Consequent upon her transfer SF-1009 Assistant Director Hanifa Bano (F), handed over charge of the post of Assistant Director at ASF Faisalabad Airport on 14th December, 2020 and taken over charge of the same post at ASF Multan Airport on 4th January, 2021.

Karachi, the 26th January, 2021

No. 51/1158/2009/FS-I.—On attaining the age of superannuation *i.e.* 60 years SF-938 Deputy Director Mishal Din has been retired from Government Service with effect from 21st January, 2021. The Officer relinquished charge of the post of Deputy Director at ASF Karachi Airport on 20th January, 2021 (A/N).

No. 41/35/2021/FS-I.—In pursuance of Cabinet Secretariat Aviation Division Islamabad Notification No.4-45/2006-ASF dated 3rd November, 2020, following Assistant Directors (BPS-17) of Airports Security Force

have assumed charge of the post of Deputy Director (BPS-18) from the dates and station as mentioned against their names:-

S/ No.	Force No.	Name	Date of Promotion	Station
1.	SF-825	Zaheer Ahmad	23-10-2020	Islamabad Airport
2.	SF-883	Ghulam Shabbir	-do-	Lahore Airport (Retired on 26-10-2020)
3.	SF-918	S. Athar Hussain Zaidi	-do-	ASF Academy (Retired on 08-11-2020)
4.	SF-919	Najmul Bari	-do-	KHI att. CSO (South) /ACD att. KHI
5.	SF-925	Syed Hadi Shah	-do-	Karachi Airport (Expired on 28-12-2020)
6.	SF-931	Attiq-ur-Rehman	-do-	Karachi /Peshawar Airport
7.	SF-932	Syed Zille Hussain	-do-	Lahore Airport
8.	SF-933	Aurangzeb	-do-	Peshawar Airport
9.	SF-934	Yasmeen Mughal (F)	-do-	HQ ASF
10.	SF-936	Khalid Hussain	-do-	Karachi Airport
11.	SF-937	Masood Ahmed	-do-	Multan Airport
12.	SF-938	Mishal Din	-do-	Karachi Airport (Retired on 21-01-2021)
13.	SF-940	Firdous Soomro (F)	26-10-2020	ASF Academy
14.	SF-941	Jahangir Ahmed	-do-	ISL att. CSO (N) Office/ CSO (N) Office
15.	SF-944	Muhammad Kashif	-do-	ISL att. CSO (North)/ASF ACD att. HQ
16.	SF-946	Ghulam Mustafa	-do-	A/G Coy att. Panjgur / KHI
17.	SF-947	Ibrar Khan	-do-	ASF Academy/ Karachi
18.	SF-949	Tanveer Ahmed	-do-	HQ ASF
19.	SF-951	Arbab Khanan Khan	-do-	Bannu att. PSH
20.	SF-952	Muhammad Mohsin Virk	-do-	KHI att. HQ ASF/ HQ ASF
21.	SF-953	Muhammad Israr	08-11-2020	HQ ASF att. PSH/ BGW att. R. Y Khan

SHAFIQ UR REHMAN,
Additional Director /Force Secretary.

HEADQUARTERS' PAKISTAN COAST GUARDS

Karachi, the 26th January, 2021

No. DG(CG)/1164/974/A.—PA-51798 Major Muhammad Khan, Baloch Regiment has assumed the charge of Company Commander Pakistan Coast Guards with effect from 26th January 2021. his services have been loaned to Ministry of Interior with effect from 1st January, 2021

KAMRAN HUSSAIN, *Maj.*
For Director General.

No. PF.2-467/SN/Admn.1/JPMC.—Mst. Sadaf Nazia D/o. Mazar Masih, Charge Nurse of this Centre has been granted LFP for 15 days with effect from 15th December, 2020 to 29th December, 2020, subject to title.

She has resumed her duty on 30th December, 2020.

No. PF.2-196/NS/Admn.1/JPMC.—Mst. Naseem Samuel D/o. Samuel, Charge Nurse of this Centre has been granted LFP for 10 days with effect from 21st December, 2020 to 30th December, 2020, subject to title.

She has resumed her duty on 31st December, 2020.

ISLAMABAD HIGH COURT

Islamabad, the 27th January, 2021

No. F. (92)/JO/Conf./IHC/909.—The Hon'ble Chief Justice has been pleased to accept the resignation of Mr. Muhammad Aamir Khalil, Civil Judge-cum-Judicial Magistrate, Islamabad, with effect from 25th January, 2021 in the public interest.

SAJID BALOCH,
Registrar.

No. PF.1-493-FA/Admn.I/JPMC.—Dr. Fayyaz Ahmad, Medical Officer of this Centre has been granted leave on full pay with effect from 20th November, 2020 to 30th December, 2020, subject to title.

On the expiry of leave, he has resumed his duty on the same post and at the same place on 31st December, 2020.

No. PF.1-308-JZA/Admn.I/JPMC.—In supersession of this Centre notification of even number dated 6th January, 2021, Mr. Jehan Zaib Arshad, Medical Technologist has been granted casual leave with effect from 28th December, 2020 to 2nd January, 2021.

JINNAH POSTGRADUATE MEDICAL CENTRE

Karachi, the 6th January, 2021

No. PF.1-308-JZA/Admn.I/JPMC.—The unauthorized absent from duty in respect of Mr. Jehan Zaib Arshad, Medical Technologist has been treated as EOL (without pay & allowances) with effect from 28th December, 2020 to 2nd January, 2021.

No. PF.2-396/SS/Admn.1/JPMC.—Mst. Sharel D/o. Sadiq Gill, Charge Nurse of this Centre for 14 days with effect from 12th October, 2020 to 25th October, 2020, has been treated as EOL (without pay and allowances).

She has resumed her duty on 26th October, 2020.

Karachi, the 12th January, 2021

No. PF.2-183/SA/Admn.1/JPMC.—Mr. Sumair Abbas S/o. Zafarullah Khan, Charge Nurse of this Centre has been granted LFP for 7 days with effect from 14th December, 2020 to 20th December, 2020, subject to title.

He has resumed his duty on 21st December, 2020.

No. PF.2-261/NM/Admn.1/JPMC.—Mr. Noor Muhammad S/o. Kokaray, Charge Nurse of this Centre has been granted LFP for 15 days with effect from 12th December, 2020 to 26th December, 2020, on medical grounds, subject to title.

He has resumed his duty on 27th December, 2020.

DR. SEEMIN JAMALI, *TI*
Executive Director.

NATIONAL COUNTER TERRORISM AUTHORITY

Islamabad, the 27th January, 2021

No. F.261/HR-II/NACTA/2021(0320).—In pursuance of Office of the Controller General of Accounts, Islamabad's Letter No.30/CGA/Estt/Deputations/NACTA/2021 dated 12th January, 2021 and Office of the Accountant General Pakistan Revenue's Office Order No.Admn-I/5-12/Deputation/2017-18-176 dated 22nd January, 2021, Mr. Muhammad Uzair Hassan, Senior Auditor (BS-16), AGPR, has assumed the charge of the post of Superintendent (BS-16), National Counter Terrorism Authority (NACTA), Islamabad, on deputation basis, for a period of three (03) years, on standard terms & conditions, with effect from 25th January, 2021.

HAFIZ FARHAN AKRAM,
Assistant Director (HR).

NATIONAL INFORMATION TECHNOLOGY BOARD

Islamabad, the 27th January, 2021

No. NITB-1(50)/2010/262.—On the recommendations of Departmental Promotion Committee and having been approved by the Executive Director, NITB, Mr. Javed Iqbal,

Assistant (BS-16) is promoted to the post of Superintendent (BS-16) with effect from 2nd December, 2020.

He will be placed on probation for a period of one year extendible for another one year if deems necessary.

MUHAMMAD ASLAM LASHARI,
Director.

NATIONAL INSTITUTE OF REHABILITATION MEDICINE

Islamabad, the 23rd January, 2021

No. F.2-144/2004-NIRM.—Mrs. Rebecca Akram, Charge Nurse (BS-17) of this Institute is hereby granted 35 days leave with full pay from 25th January, 2021 to 28th February, 2021.

After expiry of leave She is expected to join her duties on the same post and station.

No. PF.109(M.A)PC-NIRM.—Dr. Muhammad Ali Buzdar, Medical Officer (BS-17) of this Institute is hereby granted 08 days leave with full pay from 16th January, 2021 to 23rd January, 2021.

After expiry of leave he is expected to join his duties on the same post and station.

Islamabad, the 27th January, 2021

No. F.105(F.A)PC-NIRM.—Miss Farwa Ali, Psychologist (BS-17) of this Institute is hereby granted 08 days leave with full pay from 30th January, 2021 to 6th February, 2021.

After expiry of leave she is expected to join her duties on the same post and station.

DR. ADNAN RIAZ,
Deputy Director (A).

NATIONAL TRUST FOR THE DISABLED

Islamabad, the 25th January, 2021

No. 3-2003(ZH)/NTD-Admin/417.—Mr. Zafar Hayat, Assistant Accounts Officer, (BS-16), National Trust for the Disabled is granted nine (09) days LFP with effect from 4th January, 2021 to 12th January, 2021 under Revised Leave Rules, 1980.

IJAZ AHMAD,
Assistant Director.

OFFICE OF THE INSPECTOR GENERAL, FRONTIER
CORPS KHYBER PAKHTUNKHWA

Peshawar, the 12th January, 2021

No. 25/Cfm/SOG/X/RW.—On completion of probationary period of six months, under mentioned Junior Commissioned officers are confirmed in their present rank from the date as noted against each:-

1. Number 502894 Subedar Major Rasam Ali of Khyber Rifles with effect from 10th July, 2020.
2. Number 202860 Subedar Khalif Khan of Orakzai Scouts Special Operation Group with effect from 16th May, 2020.
3. Number 902400 Naib Subedar Umar Nawaz of Dir Scouts with effect from 14th October, 2020.
4. Number 1201043 Subedar Sardar Ali of Tirah Rifles with effect from 14th October, 2020.
5. Number 1102930 Subedar Sana Ullah of Mohmand Rifles with effect from 31st July, 2020.
6. Number 1001602 Subedar Shakir Ullah of Mohmand Rifles with effect from 31st July, 2020.
7. Number 1102815 Subedar Syed Kamil Hussain of Mohmand Rifles with effect from 20th October, 2020.
8. Number 702684 Naib Subedar Shahid Ahmad, Signal Establishment of Bara Rifles with effect from 22nd June, 2020.
9. Number 303486 Naib Subedar Ishfaq Muhammad of Bara Rifles with effect from 11th May, 2019.
10. Number 404418 Subedar Fazli Yaqub of Chitral Scouts with effect from 23rd February, 2019.
11. Number 404395 Subedar Muhammad Nadir Khan of Chitral Scouts with effect from 31st July, 2020.
12. Number 404553 Subedar Nasir Ullah of Chitral Scouts with effect from 30th September, 2020.
13. Number 404548 Subedar Atta ur Rehman of Chitral Scouts with effect from 30th June, 2019.

14. Number 404358 Subedar Sardar Ahmed of Chitral Scouts with effect from 30th June, 2019.

Quetta, the 24th November, 2020

15. Number 404368 Subedar Shakir Ullah of Chitral Scouts with effect from 30th June, 2019.

No. NH&MP/DIG(West)/HRM-I/2020/334.—DSP/CPO Asad Abbas of Beat-III Uthal, Sector-I N-25 Uthal, is hereby granted 08-days Monthly Rest along-with 04-days casual leave with effect from 30th November, 2020 to 11th December, 2020.

16. Number 404509 Subedar Usman Khan of Chitral Scouts with effect from 30th June, 2019.

2. During the leave period, IP/SPO Muhammad Hamid Hassan Jafar Admin Officer of Beat-III, Uthal Sector-I N-25 Uthal will look after the Operational Affairs of Beat-III Uthal, in addition to his own assignment in existing pay/scale.

17. Number 404501 Subedar Abdul Jalil of Chitral Scouts with effect from 13th April, 2020.

ALI SHER JAKHRANI, PPM, PSP

Deputy Inspector General.

18. Number 404903 Naib Subedar Aziz Ullah of Chitral Scouts with effect from 7th May, 2019.

19. Number 404984 Naib Subedar Sana Ullah of Chitral Scouts with effect from 11th April, 2020.

Islamabad, the 23rd November, 2020

20. Number 405052 Naib Subedar Shah Faisal of Chitral Scouts with effect from 2nd July, 2020.

No. NH&MP-10(3)/Posting/PSP/2020/2315.—Mr. Aftab Ahmad Pathan, PSP/Addl. IGP (BS-21) presently posted as Addl. IGP, South Region, NH&MP shall look after all the administrative, financial and operational affairs of N-5 (South) Zone, in addition to his own duties, till further orders.

21. Number 405073 Naib Subedar Muhammad Nadir of Chitral Scouts with effect from 2nd July, 2020.

This issues with the approval of Inspector General of Police, NH&MP.

22. Number 405033 Naib Subedar Muhammad Iqbal of Chitral Scouts with effect from 30th June, 2019.

ASGHAR ALI YOUSAFZAI, PSP

Deputy Inspector General (HQ).

MUHAMMAD IMRAN, Lt. Col.

Officer Incharge Records.

Islamabad, the 24th November, 2020

OFFICE OF THE INSPECTOR GENERAL OF POLICE

[NATIONAL HIGHWAYS & MOTORWAY POLICE]

Islamabad, the 23rd November, 2020

No. NH&MP-1(21)/Addl.IG(NR)/2020/752.—In exercise of powers conferred on Additional Inspector Generals, NH&MP, vide Letter No.NH&MP-28(11)/2020/Delegation/HRM/1135, dated 15th June, 2020, as recommended by Zonal Commander, IP/SPO Muhammad Nisar, S-516 is hereby assigned Acting Charge of CPO Beat-02, E-35 (in own pay, scale & rank), with immediate effect and until further orders.

The above mentioned officer is hereby directed to assume the charge of new assignment, immediately.

ABBAS HUSSAIN MALICK, PSP

Additional Inspector General.

No. NH&MP-42(7)/2020/HRM/SPO/2328.—In continuation to this office earlier Notification No.NH&MP-38(6)/18/HRM/SPO-PO/1495 dated 28th May, 2019 and in compliance of order / judgment dated 5th October, 2018 passed by the Honourable Supreme Court of Pakistan in Criminal Review Petition No.207/2016 in Criminal Original Petition No.89/2011, its connected cases and the order/ judgment dated 5th October, 2018 passed in the Criminal Original Petition No.36/2017 and 22/2017 in Criminal Original Petition 89/2011, and orders dated 16th May, 2014, 30th May, 2014, 25th February, 2016 and 17th June, 2016 passed by the Honourable Sindh High Court, Karachi, in Constitution Petition No.D-331 of 2013 and upon dismissal of Writ Petition No.2481/2019 and Intra Court Appeals No.314/2019 & 317/2019 by the Honourable Islamabad High Court, Islamabad vide Judgment passed on 11th July, 2019 & 12th February, 2020, respectively, SPO Zahid Jameel Virk (S-327) is hereby repatriated from National Highways & Motorway Police (NH&MP) to his parent department i.e. Punjab Police in his substantive rank, pay & allowances, on competition of deputation period and on his own request, with immediate effect.

2. The matter of seniority and other consequential benefits on repatriation to parent department has been settled by Honourable Supreme Court of Pakistan in the Judgment passed in CrI. Review Petition No.193/2013 in Criminal Original Petition No.89/2011, titled Ali Azhar Baloch *versus* Chief Secretary Government of Sindh reported as 2015 SCMR 456. Para-160 of the said Judgment is as under:-

“.....The officers/ officials who have been repatriated to their parent departments shall be entitled to salaries and other benefits from the date they were relieved to join their parent departments. Their seniority shall be maintained in their parent departments with their batchmates as if they were never relieved from their parent departments. Expiry of period lien shall not come in the way of the officers to deprive them from joining the parent department...”

3. The above named officers may be relieved immediately by Zonal/Sector Office with the directions to be conveyed to concerned Beat Commander for his formal relieving. However, LPC be issued after receipt of uniform articles, Arms & Ammunition and departmental E-Card issued to the officer and clearance from all concerned sections including R&W Fund.

4. This issues with the approval of Inspector General of Police, NH&MP.

ARSLAN MUSHTAQ,
Deputy Director (HRM).

PAKISTAN BUREAU OF STATISTICS

Islamabad, the 25th January, 2021

No. PBS.IBD.P-11(4)/2011-334.—With the approval of Member (RM), Mr. Fateh Gul, Assistant Private Secretary (BS-16) (Personnel No.50016379), PBS, Islamabad is granted 120 days leave on full pay (LFP) with effect from 22nd January, 2021 to 21st May, 2021 with permission to suffix weekly holidays falling on 22nd, 23rd May, 2021 respectively, subject to leave admissibility certificate from AGPR, Islamabad.

He is expected to assume the charge on the same post and station after expiry of the leave.

SADIA CHAUDHRY,
Assistant Director (Admn).

Lahore, the 25th January, 2021

No. PBS.LHR.P-3(25)/2001-III.—Mr. Nasir Khan, Statistical Officer (BS-17), Pakistan Bureau of Statistics (FBS Wing), Lahore has been granted by the competent authority 15 days leave on full pay as detailed below:-

- i) 06 days LFP with effect from 24th December, 2020 to 29th December, 2020
- ii) 09 days LFP with effect from 30th December, 2020 to 7th January, 2021 (on medical grounds)

2. After expiry of leave the officer has assumed the charge of the same post at same station on 8th January, 2021.

MUHAMMAD NAVEED ASIF MIRZA,
Assistant Agricultural Census
Commissioner (Admn).

PAKISTAN METEOROLOGICAL DEPARTMENT

Islamabad, the 25th January, 2021

No. E-16(706)/5244.—Mr. Muhammad Anwar, Electronic Engineer (BPS-17), Flood Forecasting Division, Lahore has relinquish the charge of the post on 3rd October, 2020 on account of his retirement from Government Service with effect from 4th October, 2020 on attaining the age of superannuation being his date of Birth is 4th October, 1960.

Islamabad, the 26th January, 2021

No. E-16(631)/5291.—Mr. Saleem Akhtar, Meteorologist (BS-17) RMC, Lahore has been granted 75 days LFP from 15th September, 2020 to 29th November, 2020.

On expiry of leave, Mr. Saleem Akhtar, Meteorologist (BS-17), resumed duty at the same station on 30th November, 2020.

MUHAMMAD SHOAIB,
Administrative Officer (E-I).

PAKISTAN PUBLIC WORKS DEPARTMENT

Islamabad, the 21st January, 2021

No. AI-717/700(1355).—Pursuant to Ministry of Housing & Works Notification No.F.2(9)/2016-Admn-III, dated 12th January, 2021 Mr. Haq Nawaz, assumed the

charge to the post of Superintending Engineer (QS), D.G's Office, Pak. PWD, Islamabad on 14th January, 2021.

Islamabad, the 25th January, 2021

No. AI-717/700(1175).—In pursuance of Ministry of Finance and Revenue (Finance Division) (Regulation Wing)'s Notification SRO 70(KE)/2012, dated 29th August, 2012, the competent authority has been pleased to accept the option for encashment in lieu of LPR exercised by Mr. Nadeem Akhtar Shaikh, Chief Engineer (Planning) (BS-20) Pak. PWD, Islamabad and is hereby sanctioned 365-days leave salary for the period from 15th September, 2020 to 14th September, 2021 subject to condition as laid down in the Finance Division's Notification referred to above.

He will retire from Government Service on the afternoon of 14th September, 2021 on attaining the age of superannuation (being date of Birth is 15th September, 1961).

Islamabad, the 27th January, 2021

No. AI-717/700(1286).—Pursuant to Ministry of Housing & Works Notification No.F.2(9)/2016-Admn-III, dated 20th January, 2021 Mr. Nadir Qayyum, assumed the charge to the post of Chief Engineer (C.Z), Pak. PWD, Lahore on 21st January, 2021 on current charge basis.

No. AI-717/700(1352).—Pursuant to Ministry of Housing & Works Notification No.F.2(9)/2016-Admn-III, dated 12th January, 2021 Mr. Muhammad Azam Zafar, relinquished the charge to the post of Superintending Engineer /Staff Officer, Chief Engineer (South)'s Office Pak. PWD, Karachi on 15th January, 2021 and assumed the

charge to the post of Superintending Engineer, Central Civil Circle-II, Pak. PWD, Islamabad on 18th January, 2021.

M. B. KHATTAK,
Chief Administrative Officer.

STAFF WELFARE ORGANIZATION

Islamabad, the 25th January, 2021

No. SWD-2(522)/90/Admn/356-61.—Mr. Iftikhar Ahmed, Assistant (BS-16), Staff Welfare Organization, DG's Office, Islamabad will stand voluntarily retired from Government Service with effect from 29th April, 2021. According to this office record, his date of Birth is 2nd June, 1965.

SABBAH MUSOOD,
Assistant Director (Admn).

TRADE DEVELOPMENT AUTHORITY OF PAKISTAN

Karachi, the 21st January, 2021

No. TDAP.P(1567)/Estt-86.—In pursuance of Ministry of Commerce's Notification No.1(10)/2019-DD/CTG dated 9th June, 2020, Syed Sultan Ahmed, a BS-17 Officer of Commerce & Trade Group /Assistant Director, Trade Development Authority of Pakistan, Karachi has relinquished the charge of the post of Assistant Director (BS-17) at TDAP, Karachi on 6th January, 2021 on attaining the age of superannuation and after availing one year's encashment in lieu of LPR with effect from 7th January, 2020 to 6th January, 2021.

The officer has retired from Government Service on 6th January, 2021, on attaining the age of superannuation.

ALTAF HUSSAIN,
Assistant Director (Estt-I).

The Gazette of Pakistan

PUBLISHED BY AUTHORITY

KARACHI, WEDNESDAY, APRIL 14, 2021

PART IV

Notifications issued by the minor administrations and miscellaneous notifications not included in any other part

NATIONAL COUNTER TERRORISM AUTHORITY

Islamabad, the 13th January, 2021

No. 9/248/HR-I/NACTA/2018(1339).—In compliance of the decisions taken in the NACTA's Board of Governors meeting held on 15th October, 2020, the Chairman (Board of Governors)/Minister for Interior has been pleased to constitute a sub-committee for restructuring of NACTA, comprising of the following Officers :-

Convener :

- (i) National Coordinator, NACTA.

Members :

- (ii) Director General, IB
(iii) IGP, Gilgit Baltistan
(iv) Director General (CT), ISI
(v) Secretary, Home & TA Deptt., Government of KP.

Coopted Members :-

- i) IGP (Retd.) Tariq Pervaiz (As expert)
ii) Rep. of Interior Division.
iii) Rep. of Finance Division.

Director General (Admn), NACTA to provide Secretariat assistance.

2. Terms of Reference (ToRs) is as follows :-

- i) To examine abolition or otherwise of 443 posts of Joint Intelligence Directorate (JID) or to propose any alternate arrangement.

3. The Committee shall submit its report within 90 days for placement before the Board.

JUNAID SHAFQAT SHEIKH,
Director (BoG/EC).

MINISTRY OF PLANNING, DEVELOPMENT & SPECIAL INITIATIVES

[PLANNING COMMISSION]

Islamabad, the 19th January, 2021

No. F. 5(12)CP/HRM-IV/PDR/2019.—In continuation of this Ministry's notification of even number, dated 16th November, 2020. A Sub-Group of Advisory Committee of the Planning Commission on "Industry and Enterprise" is re-constituted with the following composition and TORs :

A. Composition

Convener :

1. Mr. Abid Qaiyum Suleri

Members :

2. Mr. Waqar Sheikh, Head Corporate Affairs Pakistan & Afghanistan, Nestle.
3. Engineer M. A. Jabbar Memon, Qaim Filers, FPCCI, Karachi.
4. Mr. Asfandyar Farrukh, HUB Leather, Lahore.
5. Ms. Shanza Anwar, Steel Castings Pvt. Ltd, Gujranwala.
6. Mr. Zafar Masud, President, Bank of Punjab.

Members :

7. Mr. Harris Mufti, Sarhad Chamber of Commerce, Peshawar.
8. Mian Kashif Ashfaq, Chairman, FIEDMC, Faisalabad.
9. Mr. Muhammad Ashraf Malik, President, Sialkot Chamber of Commerce & Industry.
10. Mr. Amir Ibraheem, CEO, JAZZ.
11. Ms. Rahat Konain, Chairperson, Competition Commission of Pakistan.

Member / Resource Person :

12. Member (PSD&C)

Member / Secretary :

13. Chief, Industries & Commerce Section.

B. Terms of Reference :

- i. To work as a strategic think tank on policy issues of industry & enterprise for Planning Commission / Ministry of Planning, Development & Special Initiatives.
- ii. To promote public and private sector interface and develop participatory approach in decision making regarding industry & enterprise.
- iii. To guide Planning Commission/Ministry of Planning, Development & Special Initiatives in policy formulation for industry & enterprise.
- iv. To facilitate and help guide the Planning Commission / Ministry of Planning, Development & Special Initiatives build consensus on policies and strategies of the Planning Commission / Ministry of Planning, Development & Special Initiatives regarding industry & enterprise.

- v. To provide input and feedback regarding industry & Enterprise from non-government stakeholders to the policies/performance of the Planning Commission / Ministry of Planning, Development & Special Initiatives.
- vi. To suggest measures for accelerating Foreign investment in industrial & enterprise sector, especially relocation of industries from China and other countries in the backdrop of CPEC and to identify impediments in technology transfer, joint ventures and foreign collaboration.
- vii. To propose measures for promotion of industrialization and entrepreneurship for the development of underdeveloped areas.
- viii. To review manpower (including women participation), HRD and training needs.
- ix. To propose strategy for establishing linkages between industry and academia on sustainable lines.
- x. To suggest policy interventions in tariff and financing areas.
- xi. To identify social land environmental hazards; problems of the localities where the industrial clusters are present, problems faced by industrial sector in adapting green industrialization and propose control measures.
- xii. To identify hurdles in competitiveness, EoDB, value addition, marketing, branding faced by industry and enterprises and suggest measures which facilitate national aim of export orientation, import substitution job creation.
- xiii. To organize webinars, focus group consultations to achieve above mentioned objectives.
- xiv. Research, consultation, dialogue, discussion on any other area pertaining to industry and enterprise, as per the desire of sub-group members or as per the request of Planning Commission.

GHULAM NABI SHAIKH,
Section Officer (HRM-IV).

The Gazette of Pakistan

PUBLISHED BY AUTHORITY

KARACHI, WEDNESDAY, APRIL 14, 2021

PART V

Notifications, etc., issued by The Patent Office

NEW APPLICATIONS FOR THE PATENTS

The dates shown in the crescent brackets are the dates claimed under section 86 of the Patents Ordinance, 2000.

17th August, 2020

536/2020 Galapagos NV., Belgium (Priority 19th August, 2019, UK).—“NOVEL COMPOUNDS AND PHARMACEUTICAL COMPOSITIONS THEREOF FOR THE TREATMENT OF INFLAMMATORY DISORDERS”.

537/2020 Mr Pong, David Teng., Hong-Kong (Priority 4th June, 2020, UK).—“ELECTRONIC DEVICE FOR CONTROLLING THE OPERATION OF AN ELEVATOR”.

538/2020 FMC Corporation and FMC AGRO Singapore Pte. Ltd., Singapore (Priority 19th August, 2019, US).—“A PROCESS FOR THE PREPARATION OF CARBOXYLIC ACID DERIVATIVES OF 3-HALO-4,5-DIHYDRO-1H-PYRAZOLES”.

539/2020 MERCK SHARP & DOHME CORP.; Walter and Eliza Hall Institute of Medical Research and MSD R&D(China) Co., Ltd, Peoples China (Priority 15th August, 2019, CN).—“ANTIMALARIAL AGENTS”.

540/2020 Corn Products Development, Inc., U.S.A. (Priority 26th August, 2019, US).—“GUM ARABIC”.

19th August, 2020

541/2020 SYNGENTA CROP PROTECTION AG, Switzerland (Priority 23rd August, 2019, EP).—“PESTICIDALLY ACTIVE DIAZINE-AMIDE COMPOUNDS”.

542/2020 Engr. Ali Imran; Engr. Abdullah Saqib; Muhammad Atif; Imran Shabbir Qureshi; Dr. Quratulain Syed and Engr. Adnan Akram, Pakistan.—“DOOR PADDLE”.

543/2020 LOHIA CORP LIMITED, India (Priority 24th August, 2019, IN).—“A PROCESS AND AN APPARATUS FOR BAG FORMATION”.

20th August, 2020

544/2020 Otsuka Pharmaceutical Co., Ltd. and TAIHO Pharmaceutical Co., Ltd, Japan (Priority 20th August, 2019, GB).—“PHARMACEUTICAL COMPOUNDS”.

21st August, 2020

545/2020 XEROS LIMITED, United Kingdom (Priority 21st August, 2019, UK).—“New filter, filter unit, treatment apparatus, method and use”.

546/2020 LOHIA CORP LIMITED, India (Priority 24th August, 2019, IN).—“A SHUTTLE PAD ASSEMBLY, A SHUTTLE AND A CIRCULAR LOOM”.

APPLICATION ACCEPTED

Notice is hereby given that the person interested in opposing the grant of Patents to any of the applications referred to below at any time within four months from the date of this Patents' journal may give notice at the Patent Office on the prescribed Form P-7 of the Patents Rules 18(1) of 2003.

The six figures number shown in the right hand side are those given to applications on acceptance of the complete specification under which the specification will be printed and subsequent proceeding taken.

The figures shown within square brackets after the title of inventions indicate their classification index at acceptance.

Typed copies of the specification which are to open to public inspection can be supplied by the Patent Office on payment of the prescribed charges which may be ascertained on application to the office.

595/2008 COUNCIL OF SCIENTIFIC & INDUSTRIAL RESEARCH, India.—“Set of primers for detection and discrimination of pathogens”.

C12Q1/68.

143575

A Set of primers useful for detection and discrimination of pathogens causing syndromes comprising of

Set 1 being FP: 5' cgcttggttcggatgggag 3' (SEQ ID No. 1)

RP: 5' gccccagagacttgttagg 3' (SEQ ID No. 2)

Set 2 being FP: 5' ggcaatcggtacgtctcg 3' (SEQ ID No.3)

RP: 5' cgggggggtcttgcttac 3' (SEQ ID No. 4)

Set 3 being FP: 5' caagctgacggacattacaagg 3'(SEQ ID No. 5)

RP: 5' gtccacacgcgaaacacg 3' (SEQ ID No. 6) Set 4 being FP: 5' ttccggtcatggcgt-

taacc 3' (SEQ ID No.7) RP: 5' cgccctgcttttacgt-

tacgc 3' (SEQ ID No. 8) Set 5 being FP: 5' cggcgacgacgacgataaag 3' (SEQ ID No.9) RP:

5' caatctggtcgcgtaactcctcg 3' (SEQ ID No. 10) Set 6 being FP: 5' gggcacgtcctcgcagaag 3' (SEQ ID No. 11)

RP: 5' ccaagatgcaggtgataggtgac 3' (SEQ ID No. 12) Set 7 being FP: 5' ggtcttgccggagctg-

gtattac 3' (SEQ ID No. 13) RP: 5' tgcctccgtgaaagacaaagaca 3' (SEQ ID No. 14) Set 8

being FP: 5' tccattaacgttgcacattttgtg 3' (SEQ ID No. 15) RP: 5' acgttccggtagcgagttatctg 3' (SEQ ID No. 16) Set 9 being FP: 5' cgccgc-

caacatgctctacc 3' (SEQ ID No. 17) RP: 5' gttgcgggagggatggata 3'(SEQ ID No. 18)

Set 10 being FP: 5' tgggtacacacgtgctacaatgg 3' (SEQ ID No. 19) RP: 5' cggtactacgtcg-

gttttgtaga 3' (SEQ ID No. 20) Set 11 being FP: 5' ggctaacacatgcaagtcgagc 3' (SEQ ID No. 21) RP: 5' ggcagattccttaggcattactcacc 3' (SEQ ID No. 22) Set 12 being FP: 5' acgt-

caaatcatgccccttat 3' (SEQ ID No. 23) RP: 5' tgcagccccttgaccgtccat 3 '(SEQ ID No. 24)

Set 13 being FP: 5' gcggaacgtgggaccaatac 3' (SEQ ID No. 25) RP: 5' cgacgggggtgattttctcttc 3' (SEQ ID No. 26)

Set 14 being FP: 5' aactttttgactgccagacacac-

tattg 3' (SEQ ID No.27) RP: 5' ggatgccacccc-

ccaaaag 3' (SEQ ID No. 28) Set 15 being FP:

5' tggttactcgcttggtgaatatgt 3' (SEQ ID No.29)

RP: 5' gacgttttgccgactacatcc 3' (SEQ ID No.30)

Set 16 being FP: 5' ccctctgctggc-
gaaaagt 3' (SEQ ID No. 31).

RP: 5' ggcgaccaatctgcgaatacac 3' (SEQ ID No. 32)

Set 17 being FP: 5' aatcgatatctegggtaatgagc 3' (SEQ ID No. 33)

RP: 5' tcgaggaaaaccgtatgagaaac 3' (SEQ ID No. 34)

Set 18 being FP: 5' gctgggactgaggactgagc 3' (SEQ ID No. 35)

RP: 5' ttcaagacgggaggcatataac 3' (SEQ ID No. 36)

Set 19 being FP: 5' tggcgaacgggtgagtaaca 3' (SEQ ID No. 37)

RP: 5' ccggtattagccccagttcc 3' (SEQ ID No. 38)

Set 20 being FP: 5' cggcggcaagttcgagc 3' (SEQ ID No. 39)

RP: 5' ccaccgagacgcccacacc 3' (SEQ ID No. 40) Set 21 being FP: 5' ccaggctc-

gaggagaagc 3' (SEQ ID No. 41)

RP: 5' ccaccggcccgatgacc 3' (SEQ ID No. 42)

Set 22 being FP: 5' gccgcctgaccaccttc 3' (SEQ ID No. 43)

RP: 5' gcgggttgttggcatcag 3' (SEQ ID No. 44)

wherein the said primers are used alone or in combination.

423/2011

AstraZeneca AB, Sweden.—“MORPHOLINO PYRIMIDINE”.

C07D471/04, C07D413/14, A61K31/505 & A61P35/00.

143576

There is provided pyrimidinyl compound of Formula (I),

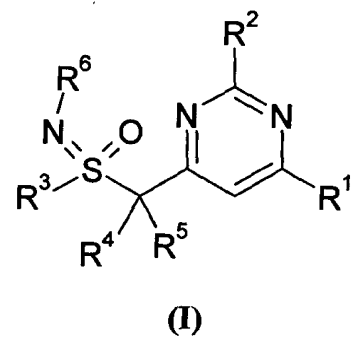

wherein:

R² is

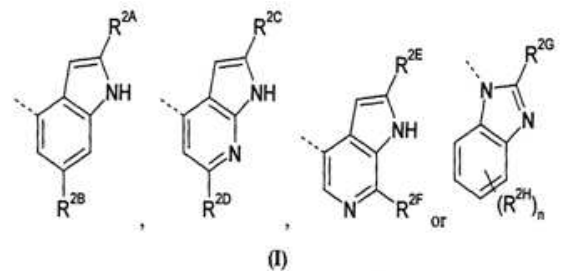

processes for their preparation and pharmaceutical composition containing.

75/2014 Novartis AG, Switzerland.—“ANTI-IL-17A ANTIBODIES AND A PHARMACEUTICAL COMPOSITION COMPRISED THEREOF”

C07K14/54, C07K16/24 & A61K 39/395.

143577

The present disclosure relates to an antibody and protein comprising an antigen-binding portion thereof that specifically binds to homodimeric IL-17A and heterodimeric IL-17AF but does not specifically bind to homodimeric IL-17F. The said antibody and protein are IL-17A antagonists (that inhibit the activities of IL-17A and IL-17AF) and are capable of inhibiting IL-17A induced cytokine production in in vitro assays, and have an inhibitory effect in an antigen-induced arthritis model in vivo. The disclosure further relates to a composition containing the said antibody and protein useful for treating pathological disorders that can be treated by inhibiting IL-17A or IL-17AF mediated activity, such as rheumatoid arthritis, psoriasis, systemic lupus erythcmatosus (SLE), lupus nephritis, chronic obstructive pulmonary disease, asthma or cystic fibrosis, or other autoimmune and inflammatory disorders.

191/2014 Novartis AG, Switzerland.—“BIARYL AMIDE COMPOUND AND PHARMACEUTICAL COMPOSITION THEREOF”.

C07D241/20, C07D403/12 & C07D401/04

143578

The present invention provides a compound of formula (I):

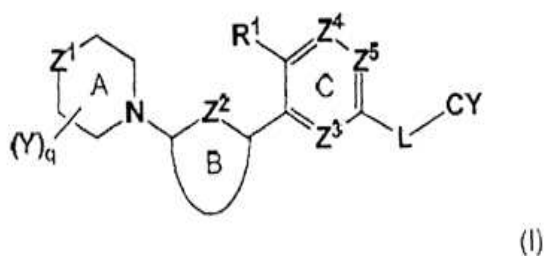

Wherein variables Y, q, R¹ and Z¹-Z⁵ are as defined in the claims of the specification.

The present invention further provides a pharmaceutical composition comprising a compound and one or more pharmaceutically acceptable carriers. The compound of present invention is a kinase inhibitor and therapeutically effective to treat the associated disorders such as cancer.

555/2014 immatics biotechnologies GmbH, Germany.—“A peptide comprising the amino acid sequence TLSSIKVEV or a variant sequence thereof and its use in immunotherapy against several tumors, such as lung cancer”.

C12N5/0783, A61K38/17 & A61K39/00.

143579

The present invention relates to a peptide comprising an amino acid sequence of SEQ ID No. 5 (TLSSJKVEV), or a variant sequence thereof which is at least 80% homologous to SEQ ID No. 5 (TLSSIKVEV), wherein said variant induces antibodies and/or T cells specifically binding to said peptide. In particular, the present invention relates to the immunotherapy of cancer. The present invention furthermore relates to tumor-associated cytotoxic T cell (CTL) peptide epitopes that serve as active pharmaceutical ingredients of vaccine compositions that stimulate anti-tumor immune responses. The present invention relates to a novel peptide sequence and its variant sequences derived from HLA class I and HLA class II molecules of human tumor cells that can be used in vaccine compositions for eliciting anti-tumor immune responses.

47/2015 UPL LIMITED, India.—“A stable herbicidal composition comprising glufosinate and process for preparing the same”.

A01N25/02, A01N57/30, A01N 57/20.

143580

The present invention provides a stable herbicidal composition comprising an active agrochemical ingredient selected from glufosinate, glufosinate hydrochloride, glufosinate monosodium, glufosinate disodium, glufosinate monopotassium, glufosinate dipotassium, glufosinate monocalcium, glufosinate ammonium, glufosinate - NH₃(CH₃)⁺, glufosinate - NH₂(CH₃)₂⁺, glufosinate - NH(CH₃)₃⁺, glufosinate - NH(CH₃)₂(C₂H₄OH)⁺, glufosinate - NH₂(CH₃)(C₂H₄OH)⁺, glufosinate methyl ester, ethyl ester, propyl ester or butyl ester at least one (C₈-C₂₀)alkyldimethyl amine N-oxide and an inorganic ammonium compound selected from ammonium sulfate, ammonium chloride, ammonium bromide, ammonium nitrate and ammonium nitrite.

Also provided is a process for preparing the composition wherein said process comprises mixing said active ingredient in a formulation vessel with water and solvent followed by the addition of calculated amount of (C₈-C₂₀)alkyldimethylamine N-oxide and inorganic

ammonium salt, and if required further customary adjuvants, solvents or other components such as wetting agent, coloring agent or defoamer followed by homogenizing the resultant mixture to obtain a clear solution. A method of weed control applying the composition of the present invention as well as a multipack herbicidal product comprising the composition are within the purview of the present invention.

73/2015 Respivert Limited, United Kingdom.—“Aromatic Heterocyclic Compound as Anti-inflammatory Compound”.

C07D401/14, A61P37/00, A61P11/00, A61P29/00 & A61K31/506.

143581

The invention relates to an aromatic heterocyclic compound of formula (I)

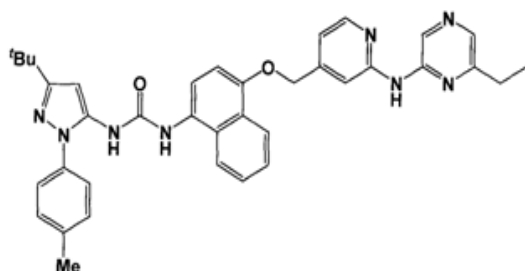

(I).

The invention further provides a pharmaceutical composition comprising a compound of formula (I) in combination with one or more pharmaceutically acceptable diluents or carriers for use in the treatment of anti-inflammatory diseases.

97/2016 ELI LILLY AND COMPANY, U.S.A.—“MONOCLONAL ANTIBODY THAT BINDS HUMAN TAU AND PHARMACEUTICAL COMPOSITION THEREOF”.

C07K16/18, A61K39/00 & A61P25/28.

143582

The present invention provides a monoclonal antibody that binds human tau comprising a light chain variable region (LCVR) and a heavy chain variable region (HCVR), wherein the LCVR comprises complementarity determining regions (CDRs) LCDR1, LCDR2, and LCDR3 and the HCVR comprises CDRs HCDR1, HCDR2, and HCDR3, wherein the amino acid sequence of LCDR1 is given by SEQ ID NO: 3, the amino acid sequence of LCDR2 is given by SEQ ID NO: 4, the amino acid sequence of LCDR3 is given by SEQ ID

NO: 5, the amino acid sequence of HCDR1 is given by SEQ ID NO: 6, the amino acid sequence of HCDR2 is given by SEQ ID NO: 7, and the amino acid sequence of HCDR3 is given by SEQ ID NO: 8.

The invention further provides a pharmaceutical composition comprising a monoclonal antibody and one or more pharmaceutically acceptable carriers, diluents or excipients. The antibody of present invention is therapeutically effective to treat neurodegenerative diseases including Alzheimer's disease Progressive Supranuclear Palsy and Pick's disease.

434/2017 Dr. Syeda Asma Bano, Pakistan.—“A fertilizer composition of Arbuscular Mycorrhizal Fungi and a process of manufacturing symbiotic fertilizer”.

C05F17/00 & C05F11/08.

143583

A fertilizer composition of Vesicular Arbuscular Mycorrhizal Fungi was invented by using plant pot culture method. Wet sieving and decantation method was adopted for the isolation of VA Mycorrhizal fungal spores (*Rhizophagus irregularis* and *Glomus aggregatum*). Then these spores were surface sterilized with 3% of Chloramin T and 200ppm of streptomycin for 15 minutes. These spores were washed with distilled water. Then soil + sand (1:1) was sterilized and it was inoculated with these spores. The host seeds of leek were grown in this inoculum. About 200 spores were added for *Rhizophagus irregularis* and *Glomus aggregatum* were added per kg of soil. Leek seedlings were planted in this mixture of substrate and spores and kept in the green house at 28°C. After 12 weeks the plants were uprooted from the pots and the roots were cut and stained to check the V AM spores, hyphae, vesicles and arbuscules. After the confirmation of the presence of V AM structures, the roots were chopped as small pieces. The chopped root pieces can act as a starter inoculum. Then a big cemented tank was taken to multiply this inoculum. Leek seedlings were again inoculated to multiply this inoculum. The plants were harvested after 12 weeks and its roots were cut into small pieces and the small root pieces were macerated with soil. This inoculum can be applied to the field directly or can be packed in polythene bags. This inoculum can also develop resistance in plants against pests and plant pathogens.

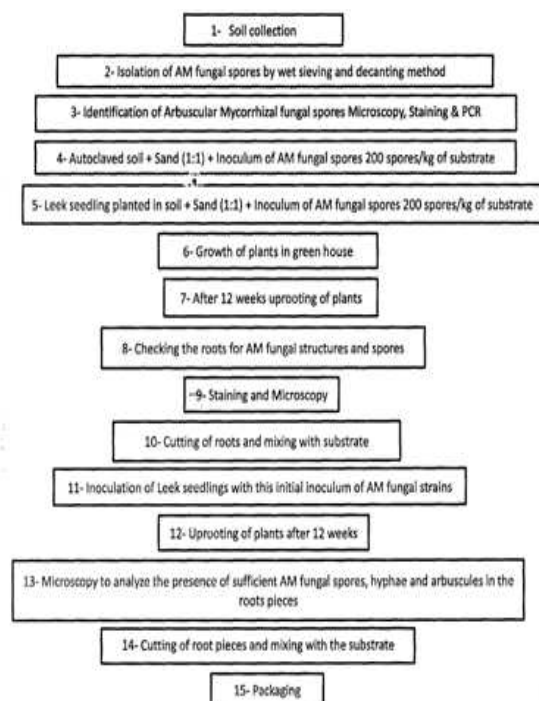

Figure 1

489/2017 AstraZeneca AB, Sweden.—“Novel dual inhibitor of phosphatidylinositol 3-kinase delta/gamma”.

C07D471/04, C07D487/04, C07D417/14, A61K 31/4439, A61P 11/00 & A61P11/06.

143584

There are disclosed certain novel compound (including pharmaceutically acceptable salts thereof),

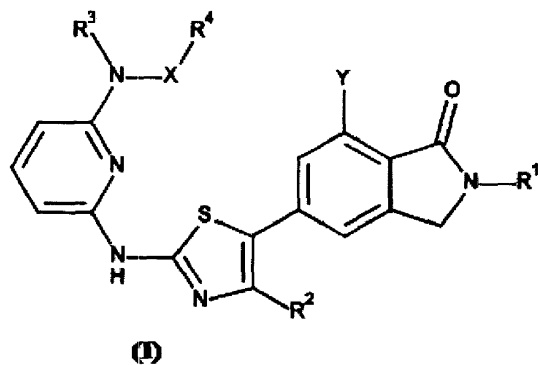

that inhibit phosphatidylinositol 3-kinase gamma (PI3K δ) and phosphatidylinositol 3-kinase gamma (PI3K γ) activity, to their utility in treating and/or preventing clinical conditions including respiratory diseases, such as asthma and chronic obstructive pulmonary disease (COPD), to pharmaceutical composition containing them and to processes for preparing such compounds.

570/2017 Arr-Maz Products, L.P, U.S.A.—“ATTRITION RESISTANT PROPPANT COMPOSITE AND ITS COMPOSITION MATTERS”.

C09D171/02, C09K8/80 & E21B43/267.

604/2017 AiCuris Anti-infective Cures GmbH, Germany.—“N-[5-(aminosulfonyl)-4-methyl-1,3-thiazol-2-yl]-N-methyl-2-[4-(2-pyridinyl)-phenyl]-acetamide free base hemihydrate and pharmaceutical composition thereof”.

C07D417/12, A61K31/4402 & A61P31/22.

143586

The present invention relates to the field of anti-viral active agents, particularly the free base hemihydrate form of N-[5-(aminosulfonyl)-4-methyl-1,3-thiazol-2-yl]-N-methyl-2-[4-(2-pyridinyl)-phenyl]-acetamide as well as methods for the manufacture thereof. The present invention relates also to the use of the above compound in the treatment of human herpes virus infections and in the preparation of pharmaceuticals comprising said compound.

652/2017 The Queen's University of Belfast, United Kingdom.—“METHOD FOR EXTRACTION OF RARE EARTH METALS”.

C07C211/63, C22B59/00 & C22B 3/26.

143587

The present invention provides a method for extracting a rare earth metal from a mixture of one or more rare earth metals, said method comprising contacting an acidic solution of the rare earth metal with a composition which comprises an ionic liquid to form an aqueous phase and a non-aqueous phase into which the rare earth metal has been selectively extracted, wherein the ionic liquid has the formula:

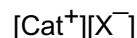

in which:

$[\text{Cat}^+]$ represents a cationic species having the structure:

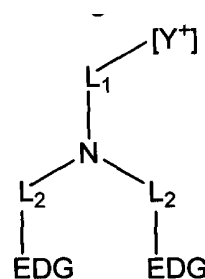

where: $[Y^+]$ comprises a group selected from ammonium, benzimidazolium, benzofuranium, benzothiophenium, benzotriazolium, borolium, cinnolinium, diazabicyclodecenium, diazabicyclononanium, 1,4-diazabicyclo[2.2.2]octanium, diazabicyclo-undecenium, dithiazolium, furanium, guanidinium, imidazolium, indazolium, indolinium, indolium, morpholinium, oxaborolium, oxaphospholium, oxazinium, oxazolium, iso-oxazolium, oxothiazolium, phospholium, phosphonium, phthalazinium, piperazinium, piperidinium, pyranium, pyrazinium, pyrazolium, pyridazinium, pyridinium, pyrimidinium, pyrrolidinium, pyrrolium, quinazolinium, quinolinium, iso-quinolinium, quinoxalinium, quinuclidinium, selenazolium, sulfonium, tetrazolium, thiadiazolium, isothiadiazolium, thiazinium, thiazolium, isothiazolium, thiophenium, thiuronium, triazinium, triazolium, iso-triazolium and uronium groups; each EDG represents an electron donating group; and L_1 represents a linking group selected from C_{1-10} alkanediyl, C_{2-10} alkenediyl, C_{1-10} dialkanylether and C_{1-10} dialkanylketone groups; each L_2 represents a linking group independently selected from C_1-2 alkanediyl, C_2 alkenediyl, C_2 dialkanylether and C_1-2 dialkanylketone groups; and $[X^-]$ represents an anionic species.

134/2018 Dr. Irfan Afzal, Associate Professor, Pakistan.—“Climate Smart Storage Technology”.

A01F25/00 & F26B17/14.

143588

Moisture is the main culprit for loss of seed viability during storage. Farmers in developing countries store their seeds in porous conventional bags which gain moisture during monsoon season due to high relative humidity in the environment and thus prone to insect and mold damage. Seeds harvested from spring seasoned crops like cereals (wheat, maize), oilseeds (soybean, sunflower, linseed) and pulses (lentil, chickpea, mungbean) have low seed moisture contents (less than 12%) which can be stored in airtight plastic anaaji bags and drums that prevent both moisture and oxygen penetration into seeds and thus reduce the storage losses. Because of proper sealing, respiration of grain and insects inside the drum/bag reduce oxygen levels to lower limits and quality is preserved, and insect infestation and fungi are controlled. This

pesticide-free organic storage monitors seed moisture contents and does not require any equipment or energy input and preserves the quality and germination capacity of stored grains, oilseeds and pulses.

631/2018 immatics biotechnologies GmbH, Germany.—“PEPTIDES AND PHARMACEUTICAL COMPOSITIONS THEREOF FOR IMMUNOTHERAPY AGAINST SEVERAL TUMORS, SUCH AS LUNG CANCER, INCLUDING NSCLC”.

C12N5/0783, A61K38/17 & A61K39/00.

143589

The present invention relates to peptides, nucleic acids and cells for use in immunotherapeutic methods. In particular, the present invention relates to the immunotherapy of cancer. The present invention furthermore relates to tumor-associated cytotoxic T cell (CTL) peptide epitopes, alone or in combination with other tumor-associated peptides that serve as active pharmaceutical ingredients of vaccine compositions that stimulate anti-tumor immune responses. The present invention relates to novel peptide sequences and their variants derived from HLA class I and HLA class II molecules of human tumor cells that can be used in vaccine compositions for eliciting anti-tumor immune responses.

705/2018 Sumitomo SHI FW Energia OY., Finland.—“A Boiler construction”.

F22B37/14, F22B37/24 & F22B 37/20.

143590

A boiler construction (10) comprising a boiler pressure body (12) having a bottom (14) and a roof (16) at a height H from the bottom and at least four planar watertube walls (18) forming a polygonal horizontal cross section with at least four corner sections (20), and a rigid support steel structure (34), the boiler pressure body being supported to the rigid support steel structure at a height between the bottom and roof, wherein a vertical corner column (40) is attached exteriorly to at least four of the at least four corner sections (20) at a height region between the bottom and roof, and the supporting of the boiler pressure body (12) is provided by supporting each of the vertical corner columns (40) to the rigid support steel structure (34) at a height from 0.1 H to 0.9 H from the bottom so as to balance vertical loads of the boiler pressure body.

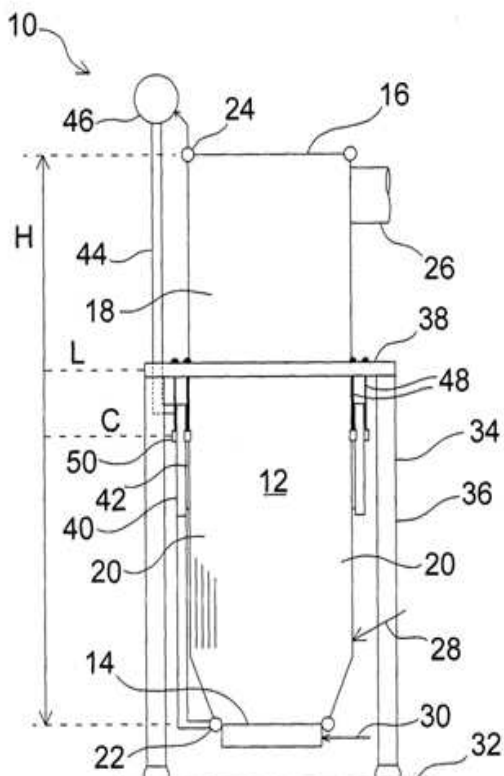

180/2020

a liquid stream of methanol (13) and a gaseous stream (14) of unreacted synthesis gas; a portion (14a) of said gaseous stream is separated as purge gas; said purge gas is subjected to a hydrogen recovery step, providing a hydrogen-containing stream (19) which is used as a hydrogen source for making the ammonia make-up gas, and a tail gas (20) which is used as a methane source for the synthesis of carbon monoxide by oxidation of a methane-containing stream.

immatics biotechnologies GmbH, Germany.—
“A peptide comprising amino acid sequence ID No.2 and pharmaceutical composition comprising the same for immunotherapy against tumors”

C12N5/0783, A61K38/17 & A61K39/00.

143592

350/2019 CASALE SA, Switzerland.—“PROCESS FOR METHANOL PRODUCTION”.

C01B3/50, C01B32/40, C01C1/04 & C07C 29/151.

143591

Integrated process comprising: synthesis of methanol from a methanol synthesis gas (12); synthesis of ammonia from an ammonia make-up gas (25), and synthesis of carbon monoxide from a methane-containing stream, wherein: the synthesis of methanol provides

The present invention relates to a peptide comprising amino acid sequence selected from group consisting of SEQ ID No. 2 or consisting of an amino acid sequence comprising an amino acid sequence according to SEQ ID No. 2 having an overall length of 14 amino acid. The peptide having SEQ ID No.2 is part of fusion protein fused to the N-terminal amino acids of the HLA-DR antigen-associated invariant chain (Ii) or is fused to an antibody.

The invention further provides a pharmaceutical composition comprising peptide having amino acid SEQ ID No.2 with carriers an excipient for eliciting anti-tumor immune response.

NEW APPLICATIONS FOR THE INDUSTRIAL DESIGNS

S. No.	Design No.	Title & Class	Applicant
19th August, 2020			
1	20474	Drum (Class-3)	1. Alka (Pvt) Ltd., Karachi, Pakistan

REGISTRATION OF DESIGNS

The following designs have been registered.

S. No.	Design No.	Title & Class	Applicant
19th August, 2020			
1.	19371	WATER COOLER (Class-03)	SHOAI BEE INDUSTRIES

S. No.	Design No.	Title & Class	Applicant
2.	19372	WATER COOLER (Class-03)	SHOAIBEE INDUSTRIES
3.	19373	WATER COOLER (Class-03)	SHOAIBEE INDUSTRIES
4.	18579	Piano Premium Pencil (Class-03)	Sayyed Engineers Limited
5.	20162	Outdoor Breakfast Chair (Class-03)	Khadija Zia and Saliha Ikram, Khadija Umar, Maheen Shah
21st August, 2020			
6.	19331	SOLID FUEL STOVE	LT COL (R) MAHMUD SHAH
7.	19624	BOTTLE (Class-03)	HILAL CARE (PRIVATE) LIMITED
8.	19625	BOTTLE (Class-3)	HILAL CARE (PRIVATE) LIMITED
9.	20153	Scanning Device (Class-12)	Alibaba Group Holding Limited

DR. MUHAMMAD FAYYAZ AHMAD,
Controller of Patents & Registrar of Designs.



PUBLISHED BY AUTHORITY

KARACHI, WEDNESDAY, APRIL 14, 2021

PART VI

Advertisements and Notices issued by Corporate Bodies and
Private Individuals on payment

MIRPURKHAS ENERGY LIMITED

FORM NO. 111

(See Rule 279)

[NOTICE OF FINAL GENERAL MEETING]

MEMBERS' VOLUNTARY WINDING UP

Members Voluntary Winding up

Name of Company : **MIRPURKHAS ENERGY LIMITED**

Notice is hereby given that Final General Meeting under Section 359(3) of the Companies Act, 2017 of Mirpurkhas Energy Limited, (under Members Voluntary Winding up) will be held at Modern Motors House, Beaumont Road, Karachi, on Friday, 30th April, 2021 at 11:30 a.m. to consider and approve the accounts and report of the Liquidator of the Company.

April 5, 2021

WASIF KHALID,
Liquidator.

Notice convening final meeting

Notice is hereby given in pursuance of Section 359 of the Companies Act, 2017 that Final General Meeting of the above-named company will be held at Modern Motors House, Beaumont Road, Karachi, on Friday, 30th April, 2021 at 11:30 a.m. for the purpose of having an account laid before them showing the manner in which the winding up has been conducted and the property of the company disposed of and of hearing and explanation that may be given by the liquidator and also of determining by a special resolution of the company, the manner in which the books, accounts and documents of the company and of the liquidator shall be disposed of.

Dated this
5th day of April, 2021

WASIF KHALID,
Liquidator.

NOTES :

1. A member entitled to attend and vote at this meeting may appoint another member as his/her proxy to attend the meeting and vote for him/her. Proxy must be a member of the Company. Proxy in order to be effective must be received by the Company not less than 48 hours before the meeting.

Statement of material facts under section 134 of the Companies Act, 2017

The above referred Final General Meeting of the Company will be convened for consideration of the final accounts and reports of the liquidator pertaining to members' voluntary winding-up of the Company.

CORRECTION OF FATHER'S NAME

My Father's correct name is Qazi Syed Abdul Ahad instead of Abdul Ahad Abdul Wahid Qazi, kindly read, write and call as per correct name.

SYED ANAS,
S/o. Qazi Syed Abdul Ahad.